

QST

October, 1938
35 cents

devoted entirely to

amateur radio

In this Issue--
Building an
expensive
single-Signal
receiver
television
with Small
Diode Tubes





POLICE RADIO

It is very likely that your city or community is giving consideration to the matter of installing new police radio facilities. High frequency radio is an old story to you but frequently it is a new one to the "city dads." Possibly, because of your experience, you will be asked to discuss the subject with them. If so, you may want to mention the name "Collins" as a synonym for performance and high-quality equipment. We make this suggestion, not with the intention of asking a favor, but in the hope and belief that you will want to recommend Collins Police Radio in the interest of your community.

Collins equipment is now being used extensively in state, county and city police radio systems all over the country. New transmitters of advanced design with powers of 50 to 1000 watts output for medium and ultra-high frequencies are in production. The new Collins uhf patrol car transmitter is of particular interest as are also the new Autotune multi-frequency transmitters for inter-zone police telegraph networks. Every Collins police installation in service has contributed to an unequalled reputation for coverage and dependability.

A bulletin describing the 50S, 50 watt Medium High Frequency Police Transmitter (illustrated above) will be sent on request.

COLLINS RADIO COMPANY

CEDAR RAPIDS, IOWA - NEW YORK, N. Y.: 11 WEST 42 STREET

The S-17 SUPER SKYRIDER

Proved by Popularity

Operating Range — 62MC to 545KC
2 Stages of Pre-Selection
Built-In Automatic Noise Limiter

Amateur Radio Operators have conclusively demonstrated their preference for the S-17 Super Skyrider in the past months. Almost without announcement, this model appeared in the Hallicrafters Line, to be greeted with enthusiastic acceptance by amateurs everywhere. Quickly it assumed its place as the most popular receiver of the famous Hallicrafters Line. And no wonder—the S-17 offers complete coverage from 5 to 550 meters. Two stages of pre-selection, a Dickert Built-In Noise Limiter, 1000° Electrical Band Spread—every electrical and mechanical feature the amateur could want—all available at an extremely modest price for so much real receiver value. See the S-17 Super Skyrider at your dealer's today! Operate it! Compare the value!

5-550 Meters Continuous Coverage
2 Stages Pre-Selection
Built-In Automatic Noise Limiter
13 Tubes
Wide Range Variable Selectivity

1000° Electrical Band Spread
6 Bands
8" Meter
Better than 1 microvolt average
Sensitivity on all bands

All Hallicrafters Receivers available on Liberal Time Payments

2611 Indiana Ave., Chicago, U. S. A.

the hallicrafters inc.

Cable Address: HALLCRAFT, Chicago



Now at
\$125⁵⁰
LESS SPEAKER
AND CRYSTAL

The New HT-4 a hallicrafters transmitter 325 Watts Phone - 450 watts CW

In the development of this new transmitter unit in the Hallicrafters Transmitter Line, this organization followed the same policies formulated when the first Hallicrafters Transmitter was designed.

There was no blind pursuit of tradition, the problem was approached from a fresh viewpoint with the principles of functional design ever in mind. The result is the Model HT-4, a distinct departure from customary design, yet meeting every requirement for a transmitter of its capacity, with a new and amazing simplicity of operation and compactness in design.

The result is the Model HT-4, a distinct departure from customary design, yet meeting every requirement for a transmitter of its capacity, with a new and amazing simplicity of operation and compactness in design.—conservatively rated at 325 Watts Phone Output—450 Watts CW Output in the equivalent of the ordinary 500 Watt Phone Input Transmitter in performance.

Every detail of its construction has been closely scrutinized for dependability, all components are generously oversized, the entire transmitter is built in the "commercial" style for the utmost reliability in operation. Ask your Hallicrafters Dealer about the Model HT-4 or write for complete specifications and description.

the hallicrafters inc.

2611 Indiana Avenue, Chicago, U. S. A. Cable Address: HALICRAFT, Chicago

WORLD'S LARGEST BUILDERS OF AMATEUR COMMUNICATIONS EQUIPMENT

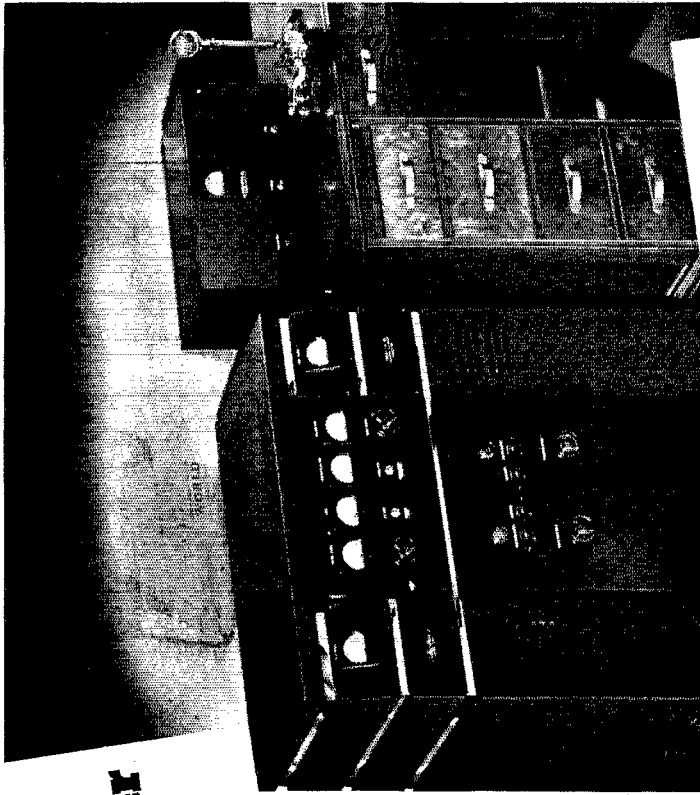

SPECIFICATIONS

CARRIER POWER OUTPUT—225 WATTS PHONE.
450 WATTS CW RANGE—ANY 3 CRYSTAL CONTROLLED
FREQUENCY RANGE—ANY 10 to 160 METER AMATEUR
BANDS
FREQUENCIES IN THE 10 to 160 METER AMATEUR
BANDS
1—6L6 Doubler 2—6X4 Rectifier 2—6Y4 Rectifier 2—6X4 Rectifier
TUBES—1—5Y4 G. Oscillator 2—6X4 Rectifier 2—6X4 Rectifier 2—6X4 Rectifier
1—6X4 Rectifier 2—6X4 Rectifier 2—6X4 Rectifier 2—6X4 Rectifier
2—2A3 Audio Drivers 2—866 Rectifier operating in
1—6X4 Rectifier—Quickly set up for any final tank coil.
R. F. SELECTION—Quickly set up for any final tank coil.
POWER SUPPLY—3 Heavy Duty Power Supplies, 2000 Volt.
Amps connection—3 Heavy Duty Power Supplies.
POWER SUPPLY—3 Heavy Duty Power Supplies.
1000 Volt and 375 Volt Voltage Excitation Plate Current. Plate
METERS—Plate Voltage, Modulator Plate Current, Plate
Current, Amps—Filament Power, Tune-Over, Band Switch, Amp
CONTROL—Filament Rheostat, Plate Adjustment, Band Switch, Amp
Power tuning.
POWER SUPPLY—110 Volts, 60-60 cycles.
CABINET—"CONSOLID" Type. Heavy steel construction, finished in black and chromium.

QST

devoted entirely to

AMATEUR RADIO

PUBLISHED, MONTHLY, AS ITS OFFICIAL ORGAN, BY THE AMERICAN RADIO RELAY LEAGUE, INC., AT WEST HARTFORD, CONN., U. S. A.; OFFICIAL ORGAN OF THE INTERNATIONAL AMATEUR RADIO UNION

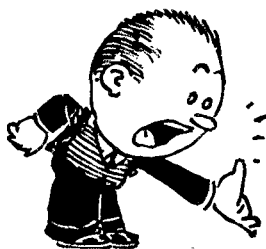

OCTOBER

1938

Volume XXII

Number 10



Kenneth B. Warner, General Manager of A.R.R.L. Publications; Ross A. Hull, Editor; James J. Lamb, Technical Editor; George Grammer, Assistant Technical Editor; Clark C. Rodimon, Managing Editor; David H. Houghton, Circulation Manager; Ralph T. Beaudin, Assistant Circulation Manager; F. Cheyney Beekley, Advertising Manager; Charles Brunelle, Assistant Advertising Manager.

Editorial and Advertising Offices

38 La Salle Road
West Hartford, Connecticut

Subscription rate in United States and Possessions and Canada, \$2.50 per year, postpaid; all other countries, \$3.00 per year, postpaid. Single copies, 25 cents. Foreign remittances should be by international postal or express money order or bank draft negotiable in the U. S. and for an equivalent amount in U. S. funds.

Entered as second-class matter May 29, 1919, at the post office at Hartford, Connecticut, under the Act of March 3, 1879. Acceptance for mailing at special rate of postage provided for in section 1103, Act of October 3, 1917, authorized September 9, 1922. Additional entry at Concord, N. H., authorized February 21, 1929, under the Act of February 28, 1925.

Additional second-class entries to cover sectional editions authorized March 20, 1935. Copyright 1938 by the American Radio Relay League, Inc. Title registered at United States Patent Office.

The Contents

Editorials	9
A Visit to W1AW F. E. Handy, W1BDI	10
A Low-Cost Single-Signal Receiver George Grammer, W1DF	14
Next Month — National Convention Story	18
Amateurs Aid Hughes on World Flight	19
W2IXY and VR6AY Receive Public Service Certificates	20
Massachusetts State Convention	20
Building Television Receivers With Standard Cathode-Ray Tubes J. B. Sherman	21
What the League Is Doing	26
A Six-Band Kilowatt Transmitter . J. E. Jennings, W6EI	28
Characteristics of Sky-Wave Transmission Harner Selvidge, W9BOE	32
Refinements in Combination Exciters T. M. Ferrill, Jr., W1LJI	36
Radio Control of Powered Models Clinton B. DeSoto, W1CBD	42
Some Thoughts on Rotary Beam Antennas Arthur H. Lynch, W2DKJ	45
What, No Meters? Fred Sutter, W8QBW—QDK	49
Midwest Division Convention	50
Silent Keys	50
Army-Amateur Radio System Activities	51
How Would You Do It? Crystal Oscillator Keying Systems	52
A Compact 100-Watt Transmitter Thomas Sue Chow, W6MVK	54
Low Z for Linearity M. A. Brown, W6ABF and J. N. A. Hawkins, W6AAR	57
56-Mc. DX Tests	59
Hints and Kinks	60
I.A.R.U. News	63
Navy Day Receiving Competition	64
Correspondence Department	73
A.R.R.L. QSL Bureau	102
Standard Frequency Transmissions	106
New Data on Direction of Wave Propagation	109
Hamads	123
QST's Index to Advertisers	126

ALL PUNCHED CHASSIS GIVEN

TO PURCHASERS OF NECESSARY TAYLOR TUBES FOR THIS 275 WATT DUAL R F UNIT DE LUXE ALL-BAND TRANSMITTER

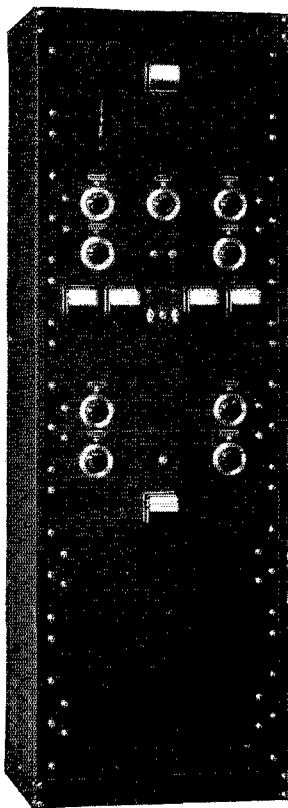

To quickly establish the popularity of this most modern transmitter, we are making available, through your distributor, free of all charges, the four 13" x 17" x 3" sturdy metal chassis, used in this rig, with all socket and other large holes already punched. (Holes 1/4" and smaller are not drilled.)

- THIS TRANSMITTER is NEW — DIFFERENT — BETTER. 275 WATTS INPUT ON ALL BANDS — 5 to 160 METERS. TZ-40's in Push-pull in the final amplifiers modulated by TZ-40's in Class B.
- PEAK COMPRESSIONS CONTROL BUILT-IN. (Thordarson New Amateur Speech Amplifier No. T-17K20M or equivalent is recommended.)
- TWO SEPARATE R F UNITS one for 5-10-20 Meters — the other for 40-80-160 Meters — each complete from Crystal Oscillator to P. P. Final.
- ALL POWER SUPPLIES, Meters, Modulator and Antenna equipment common to both R F units — thus making possible a new low price standard. The flip of one toggle switch gives *instant* use of either of two selected bands such as 75 and 20, 160 and 10, 20 and 5, etc. Acclaimed the "Hit of the Chicago Convention." Get full information in the

NEW 1938-1939 TAYLOR TUBES MANUAL AND CATALOG NOW READY

All new circuits—New Technical Data—including complete building information on the De Luxe Dual Unit Rig shown here and on other brand new transmitter circuits. You liked the last Taylor Manual — THIS IS BETTER THAN EVER — AND IT'S YOURS FOR THE ASKING — at your distributors or write direct to us.

Taylor HEAVY CUSTOM BUILT DUTY Tubes

YOU ASKED FOR IT...

HERE IT IS - NEW

TAYLOR BEAM POWER TUBE T-21

During the past two years, hundreds of amateurs have asked for a Taylor Beam tube for their Oscillator and other low-powered stages—many expressed this desire so they could be “100% Taylor Tube equipped.” Taylor now presents a Beam Tube that lives up fully to the Taylor Tubes’ slogan “*More Watts per Dollar.*” Tests prove a better than average output in all R F services. The usual broad Taylor guarantee protects you—insist on Taylor T-21 for best performance. Write for complete technical bulletin.

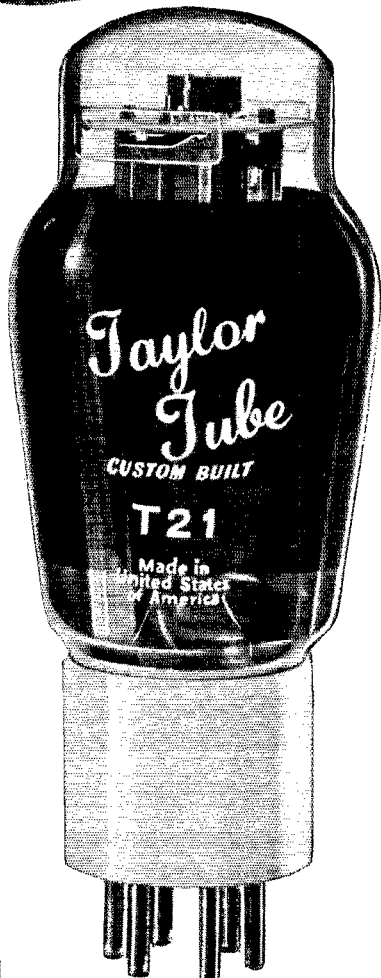

BEAM-TETRODE, POWER AMPLIFIER 6 PRONG ISOLANTITE BASE

Max. Plate Dissipation	21 watts
Max. Screen Dissipation	3.5 watts
Heater Voltage	6.3 volts
Heater Current	0.9 amp.
Grid to Plate Capacity	1.4 mmf.
Output Capacity	11.5 mmf.
Input Capacity	11.5 mmf.
Max. Plate Voltage	400 volts
Mutual Conductance	6000 ohms
Amp. Factor	135
Max. Plate Current	95 m.a.
Max. Screen Current	8 m.a.

NEW! 872A \$12.00

Taylor Tubes announces a New type 872A — different and better. Tried and proven in actual Broadcast station use. Plate anode and shield of Speer Processed Carbon. A performance test will thoroughly prove the superiority of Taylor 872A's. Write for technical bulletin.

T-21 ACTUAL SIZE

\$195

RECOMMENDED BY LEADING PARTS DISTRIBUTORS

"More Watts Per Dollar"

TAYLOR TUBES, INC., 2341 WABANSIA AVE., CHICAGO, ILLINOIS

Section Communications Managers of the A.R.R.L. Communications Department

All appointments in the League's field organization are made by the proper S.C.M., elected by members in each Section listed. Mail your S.C.M. (on the 16th of each month) a postal covering your radio activities for the previous 30 days. Tell him your DX, plans for experimenting, results in phone and traffic. He is interested, whether you are an A.R.R.L. member or get your QST at the newsstands; he wants a report from every active ham. If interested and qualified for O.R.S., O.P.S. or other appointments he can tell you about them, too.

Eastern Pennsylvania	W3QP	ATLANTIC DIVISION John Buck Morgau		Blue Bell
Maryland-Delaware-District of Columbia	W3BAK W3BEL W8CSE W8OFO	Edgar L. Hudson W. W. Filson Ed Preston Kendall Speer, Jr.	247 E. Atlantic Ave. 10 Lincoln Ave.	Laurel, Delaware Audubon Tully Lowber
Southern New Jersey		CENTRAL DIVISION		
Western New York	W9RMN	Leslie M. Dickson	Edellyn Farins	Waukegan
Western Pennsylvania	W9QG W9ARU W8DPE W8AQ W9UIT	Noble Burkhart Darroll A. Downard Harold C. Bird E. H. Gibbs Aldrich C. Krones	R. 4, Box 1 116 N. Longworth Ave. R.F.D. 2 405 Broad St. 3127-A West Madison St.	Indianapolis Louisville Pontiac Wadsworth Milwaukee
		DAKOTA DIVISION		
North Dakota	W9RZA	Ernest Bloch	Box 202	Thompson
South Dakota	W9VOD	Dr. A. L. Russell	R.F.D. 3	Wall
Northern Minnesota	W9IGZ	Edwin L. Wicklund	608 N. Huron Ave.	Kensington Spring Valley
Southern Minnesota	W9YNQ	Millard L. Bender		
		DELTA DIVISION		
Arkansas	W5ABI	H. E. Vette	4415 West 12th St.	Little Rock
Louisiana	W5DKR	Eugene H. Treadaway	2749 Myrtle St.	New Orleans
Mississippi*	W5GHP	Robert E. Barr	673 Hillcrest St.	Lucedale
Tennessee	W4DEP	B. G. Lowrey Smith		Memphis
		HUDSON DIVISION		
Eastern New York	W2LU	Robert E. Haight	511 South Holmes St.	Scotia
N. Y. C. & Long Island	W2AZV	E. L. Baumach	102 Central Ave.	Massapequa, L. I.
Northern New Jersey	W2GMN	Fred C. Read	1014 North Ave.	Elizabeth
		MIDWEST DIVISION		
Iowa	W9ARE	Clyde C. Richelleu	815 Dunham St.	Burlington
Kansas	W9FB	Harry E. Legler	304 Miami St.	Hawatha
Missouri	W9CLD	Miss L. Vetha Alendorf	1015 W. 3rd St.	Joplin
Nebraska	W9FAM	Samuel C. Wallace	Green St.	Clarks
		NEW ENGLAND DIVISION		
Connecticut	W1CTI	Frederick Ellis, Jr.	19 Merrill Rd.	Norwalk
Maine	W1FBJ	Winfield A. Ramsdell	1188 Washington Ave.	Portland
Eastern Massachusetts	W1LWC	Sam Gross	Pleasant St.	Marshfield Hills
Western Massachusetts	W1JAH	William J. Barrett	239 Columbia St.	Adams
New Hampshire	W1BFT	Carl B. Evans	80 No. State St.	Concord
Rhode Island	W1HRC	Clayton C. Gordon	192 Washington Ave.	Providence
Vermont	W1GNF	Alvin H. Battison	1 Central St.	Windsor
		NORTHWESTERN DIVISION		
Alaska	K7ENA	Leo E. Osterman	Customhouse	Wrangell
Idaho	W7EMT	Carl Etchelberger	Route 2	Elma
Montana	W7BL	C. Woodhouse	Holter Dam	Wolf Creek
Oregon*	W7RNO	J. R. MacManiman	1545 N. E. 48th Ave.	Portland
Washington	W7FCG	W. Beale	R. 4, School Ave.	Walla Walla
		PACIFIC DIVISION		
Hawaii*	K6OCE	Harold C. Smith	P. O. Box 150	Honolulu
Nevada	W6BIC	Edward W. Heim	509 Claremont St.	Reno
Santa Clara Valley	W6FPW	Elbert Amarantes	454 Washington St.	San Jose
East Bay	W6JTV	Harold J. Burchfield	2240 106th Ave.	Oakland
San Francisco	W6SG	Alan D. Whittaker, Jr.	79 Elfinor Ave.	Mill Valley
Sacramento Valley	W6GZY	L. C. Rickenham	2720 22nd St.	Sacramento
Philippines	KA1GR	George L. Rickard	Box 849	Manila
San Joaquin Valley	W6LPE	Angelo V. Astone	729 Safford	Fresno
		ROANOKE DIVISION		
North Carolina	W4OG	H. S. Carter	P. O. Box 111	Winston-Salem
South Carolina	W4BOE	Ted Ferguson	1213 College St.	Columbia
Virginia	W3UVA	Charles M. Waff, Jr.	2607 Stuart Ave.	Richmond
West Virginia	W8HD	C. S. Hoffmann, Jr.	47 Lynwood Ave.	Wheeling
		ROCKY MOUNTAIN DIVISION		
Colorado	W9FA	Glen Glasscock	2164 So. Corona St.	Denver
Utah-Wyoming	W7CLG	Ernest E. Parshall	Salt Creek Electric Plant	Midwest, Wyoming
		SOUTHEASTERN DIVISION		
Alabama	W4DGS	James F. Thompson	102 Narrow Lane Rd.	Montgomery
Eastern Florida	W4DVO	L. A. Connolly	719 So. Willow Ave.	Tampa
Western Florida*	W4AXP	Oscar Cederstrom	Second St. & Bruce Ave.	De Funiak Springs
Georgia-Cuba-Isle-of-Pines*-Porto Rico-Virgin Islands	W4PM	Charles W. Davis	2136 N. E. Boulevard Dr.	Atlanta, Ga.
		SOUTHWESTERN DIVISION		
Los Angeles	W6MQM	Ralph S. Click	979 Farnam St.	Los Angeles
Arizona	W6KFC	Victor C. Clark	747 E. Polk St.	Phoenix
San Diego	W6JRM	Howard K. Breedlove	R. 2, Box 636	San Diego
		WEST GULF DIVISION		
Northern Texas	W5DXA	Lee Hughes	125 N. Main St.	Childress
Oklahoma	W5CEZ	Carter L. Simpson	2010 So. 4th St.	Ponca City
Southern Texas	W5BHO	Dave H. Calk	6726 Ave. Q	Houston
New Mexico	W5CGJ	Joseph M. Eldott		Chamita
		MARITIME DIVISION		
Maritime	VE1DQ	A. M. Crowell	69 Dublin St.	Halifax, N. S.
		ONTARIO DIVISION		
Ontario	VE3SG	Fred H. B. Saxon	302 Lee Ave.	Toronto, Ont.
		QUEBEC DIVISION		
Quebec	VE2EE	Stan Comach	780 Brault Ave.	Verdun, P. Q.
		VANALTA DIVISION		
Alberta	VE4GE	C. S. Jamieson	581 W. Riverside Drive	Drumheller, Alta.
British Columbia	VE5HP	J. Hepburn, Jr.	335 Foul Bay Road	Victoria
		PRAIRIE DIVISION		
Manitoba	VE4BG	A. J. R. Simpson	635 Garfield St.	Winnipeg
Saskatchewan	VE4SY	Arthur Chesworth	1071 4th Ave., N. W.	Moose Jaw

* Officials appointed to act until the membership of the Section choose permanent S.C.M.'s by nomination and election.

REACTOR SPECS.

1. **RATED D.C.**
 - (A) This figure should include the current drawn by the bleeder as well as the load current.
 - (B) Specify maximum and minimum current.
2. **INDUCTANCE REQUIRED AT RATED D.C.**
 - (A) For smoothing choke - specify inductance required at maximum D.C.
 - (B) For swinging choke - specify inductance required at minimum D.C. and inductance required at maximum D.C.
 - I. Ordinarily, an inductance change of 5 to 1 may be obtained when the current change is 10%.
3. **VOLTAGE DELIVERED AT OUTPUT OF FILTER.**
 - (A) Insulation test should be at least twice this value plus 1000 volts.
4. **D.C. RESISTANCE.**
 - (A) In low voltage high current rectifiers the choke resistance is important because of its effect on the regulation.

Kandid Ken-O-Talk, No. 11

• REACTOR SPECIFICATIONS •

REACTORS play a very important part in the satisfactory operation of any power supply. If the inductance of the first, or input reactor is not high enough, poor regulation may result. Even more serious than this, unstable rectifier operation may be caused. This will give an output having a high percentage of ripple and it may overload the plate transformer.

A simple way to determine the minimum inductance required for an input reactor is to divide the D. C. output voltage by the output in milliamperes. If the load is variable, then a swinging reactor should be used. It should be rated so the inductance at the minimum current is equal to the voltage divided by this current in milliamperes. In order to meet this specification, the inductance at the maximum current is usually twice as large as would be indicated by the formula
$$\text{Henries} = \frac{\text{DC Volts}}{\text{DC Milliamperes}}$$
 This is desirable from two points of view. It reduces the ripple in the output voltage and it also maintains the load drawn from the plate transformer at a favorable value.

If the load is constant, the input reactor should not be of the swinging type, for this gives a lower inductance at high current, for the same size, than the smoothing type. The inductance of the smoothing type reactor should be selected so that at least 50% more than needed is available. Then if the current demand is lower than calculated, unstable operation will not result.

The ripple percentage which is desired in the output is determined by the inductance of the reactor, the capacity of the condenser, and the number of filter sections used. For a single section choke input filter the percentage ripple is equal to $\frac{85}{LC}$ when L is in henries and C is in microfarads. If a second stage of filtering is added the output ripple may be determined by multiplying the ripple at the output of the first stage by $\frac{1.77}{LC}$ where L is the inductance (in henries) of the second reactor and C is the capacity (in microfarads) of the second condenser.

From the above it will be seen that the inductance needed to obtain stable rectifier operation is the most important requirement in the selection of reactors. The ripple content of the output may be determined by the size of condenser used and by the number of filter sections.

F. P. Kenyon

The American Radio Relay League



• **T**HE AMERICAN RADIO RELAY LEAGUE, INC., is a non-commercial association of radio amateurs, bonded for the promotion of interest in amateur radio communication and experimentation, for the relaying of messages by radio, for the advancement of the radio art and of the public welfare, for the representation of the radio amateur in legislative matters, and for the maintenance of fraternalism and a high standard of conduct.

It is an incorporated association without capital stock, chartered under the laws of Connecticut. Its affairs are governed by a Board of Directors, elected every two years by the general membership. The officers are elected or appointed by the Directors. The League is non-commercial and no one commercially engaged in the manufacture, sale or rental of radio apparatus is eligible to membership on its board.

"Of, by and for the amateur," it numbers within its ranks practically every worth-while amateur in the nation and has a history of glorious achievement as the standard-bearer in amateur affairs.

Inquiries regarding membership are solicited. A bona fide interest in amateur radio is the only essential qualification; ownership of a transmitting station and knowledge of the code are not prerequisite. Correspondence should be addressed to the Secretary.

HIRAM PERCY MAXIM, FIRST PRESIDENT

OFFICERS

- President*.....EUGENE C. WOODRUFF, W8CMP
State College, Pa.
- Vice-President*.....GEORGE W. BAILEY, W1KH
Weston, Mass.
- Secretary*.....KENNETH B. WARNER, W1EH
West Hartford, Connecticut
- Treasurer*.....ARTHUR A. HEBERT, W1ES
West Hartford, Connecticut
- Communications Mgr.*...F. EDWARD HANDY, W1BDI
West Hartford, Connecticut
- ◆
- General Counsel*.....PAUL M. SEGAL
1026 Woodward Building, Washington, D. C.
- ◆

Address all general correspondence to the administrative headquarters at West Hartford, Connecticut

DIRECTORS

- President*
EUGENE C. WOODRUFF.....W8CMP
234 W. Fairmount Ave., State College, Pa.
- Vice-President*
GEORGE W. BAILEY.....W1KH
74 Webster Road, Weston, Mass.
- Canadian General Manager*
ALEX. REID.....VE2BE
169 Logan Ave., St. Lambert, P. Q.
- Atlantic Division*
WALTER BRADLEY MARTIN.....W3QV
Box 612, Roslyn, Pa.
- Central Division*
R. H. G. MATHEWS.....W9ZN
100 East Ohio St., Chicago
- Dakota Division*
FRED W. YOUNG.....W9MZN
Apartment 16, 500 Harvard St., Minneapolis, Minn.
- Delta Division*
E. RAY ARLEDGE.....W5SI
P.O. Box 286, Pine Bluff, Ark.
- Hudson Division*
KENNETH T. HILL.....W2AH
115 Willow St., Douglaston, L. I., N. Y.
- Midwest Division*
FLOYD E. NORWINE, JR.....W9EFC
120 South Fourth St., St. Louis, Mo.
- New England Division*
PERCY C. NOBLE.....W1BVR
37 Broad St., Westfield, Mass.
- Northwestern Division*
RALPH J. GIBBONS.....W7KV
c/o United Air Lines, Portland, Ore.
- Pacific Division*
J. L. McCARGAR.....W6EY
66 Hamilton Pl., Oakland, Calif.
- Pennock Division*
H. L. CAVENESS.....W4DW
State College Station, Raleigh, N. C.
- Rocky Mountain Division*
EDWARD C. STOCKMAN.....W9ESA
618 So. Williams St., Denver
- Southeastern Division*
BENNETT R. ADAMS, JR.....W4APU
1512 Grove Place, Homewood, Ala.
- Southwestern Division*
CHARLES E. BLALACK.....W6GG
443 Main St., El Centro, Calif.
- West Gulf Division*
WAYLAND M. GROVES.....W5NW
c/o Humble Pipe Line, Mt. Pleasant, Texas



"It Seems to Us — —"

THERE'S an old proverb that was written long before the days of radio amateurs but which we could well embroider in old filament wire and hang on our shack walls: "Be not too zealous; moderation is best in all things."

Yes, even in amateur radio.

That probably sounds like a strange pronouncement coming from us whose traditional duty it is to keep amateur radio activity whipped up to a fine lather by the promotion of all sorts of operating activities and by the monthly exhortations of this illustrious journal. Yet, even so, we mean it, and in our own best interests, of course.

What we particularly have in mind is that unbalanced amateur activity is quite capable of injuring one's health—physical and mental—sometimes permanently, and that such immoderation is therefore unwise and something to be discouraged. Not that ham radio is a hazardous avocation; precisely the same thing is true of innumerable other pleasant human activities when carried to excess: too much sunshine, too much exercise, too much eating, too much mental work, too much loafing, too much intensive work on any complex hobby, all exact their penalties from the old shell. And so appealing are the myriad fascinations of amateur radio that, unless one is a bit circumspect about it, it is all too easy to be led into immoderation. The average ham doesn't get enough sleep or exercise, he smokes too much, he works too hard at it and keeps himself under a strain too long at a time. Most of us live, eat and sleep amateur radio; it fills our waking moments and our dreams. Our point is that too much of this isn't good for us or for the game. It used to be even worse in the old spark days. Many an old-time spark man is permanently deaf in one ear from parking it hours on end alongside a crashing rotary gap, and the mark of the amateur in those days used to be the red-rimmed eyelids inflamed by the volatitized zinc of whirring electrodes. Traffic men still sit down to a hard night's work with cob pipes pre-loaded in a row, and in the average ham shack after a good DX night the cigarette butts are to be bailed out by the

quart. The amount of sleep lost in our contests is prodigious. Night after night we sit humped hollow-chested over our junkpiles to all hours, straining every nerve to read through interference, and the next day we're devoting every stolen minute to planning some new piece of gear, until we don't know whether we have families, jobs or bodies. After years of this sort of treatment the old human frame commences to complain. We've really been moved to mention this subject editorially because we've encountered several amateurs recently who are paying the price for having loved radio not wisely but too well.

In *The Radio Amateur's Handbook* there is still published The Amateur's Code, a platform created for us many years ago by an illustrious amateur. Most of you know it. It has six points. The amateur is gentlemanly, he is loyal, he is progressive, he is friendly, he is patriotic. The other point we quote in full:

The Amateur is Balanced. Radio is his hobby. He never allows it to interfere with any of the duties he owes to his home, his job, his school, or his community.

It's a good standard, isn't it? As we enter upon our period of intense winter activity it would be well for us to think a little about this. Moderation in all things, including amateur radio, will make a ham healthy, wealthy and wise. Radio is our servant; let us not become enslaved to it. We'll have more fun out of it, enjoy it more heartily, if we retain sensible perspective and don't overdo it. We'll think more clearly, get things done better, make better contributions to our art, have more zest for our game and actually last longer in amateur radio, if we use a little common sense about the hours we keep and the factor of balance in the lives we lead. Go to it like anything when you have to, of course, when there's an emergency or a contest on; but radio will be infinitely more pleasurable if approached with the clear head and healthy body that come from living a reasonably balanced life. Therefore we say be not too zealous; remember that moderation is best in all things.

K. B. W.

A Visit to WIAW

The New Maxim Memorial Station Now in Operation

By F. E. Handy,* WIBDI

THE evolution of your A.R.R.L.'s Headquarters station from a modest corner-of-a-room 20-watt outfit into a station with several complete kilowatt transmitters ready to go on 'phone or telegraph at the throw of a switch is something which parallels the growth of amateur radio and the League itself. It is hard to put in a few words all that it represents. The sturdy brick-and-stone building is of colonial design, large enough to house all the modern facilities installed. The signal, WIAW, constantly on the air to work as many amateurs as possible, constitutes the most fitting, and in a true sense a "living" memorial. The station was erected by your Board in tribute and recognition to our first leader who envisioned a continuing organization to represent the amateur, whose tireless efforts and planning brought the representative national

ized Amateur Radio, Beloved First President of the American Radio Relay League." President Woodruff unveiled the Memorial Tablet shortly after 2 P.M. that date, in the presence of a large number of League members, with all A.R.R.L. officers, and the Headquarters staff in attendance. Dignitaries from the town of Newington wished us well. Gen. Ladd represented Connecticut's Governor. The ceremonial was broadcast over the CBS network, and locally by WDRC and WTIC. After the dedication the station devoted its first big evening to intensive operations in the Maxim Memorial Relay, results of which, appear elsewhere in this issue. WTIC carried an evening *b/c* mentioning progress of the Relay. Thus was the new station opened.

The first famous 1AW was operated by H. P. M. himself. When A.R.R.L. grew to sizable proportions a small station was established in the Headquarters offices at Main St., Hartford, for work direct with members and amateurs responsive to their request. This, the first 1MK, was installed in '24. More equipment was added when A.R.R.L. moved to larger offices on Park Street. In 1927 the Board of Directors ordered the creation of a real man-size station, with the full power permitted amateurs. By February of 1928 this was completed. W1MK now had a two transmitter status. Its operating program and equipment was explained fully in December 1930 *QST*. The station set the example, followed expeditions around the globe with useful contact, and the call became a by-word for operating excellence. After eight years of fruitful service and uncounted thousands of contacts this Headquarters station was brought

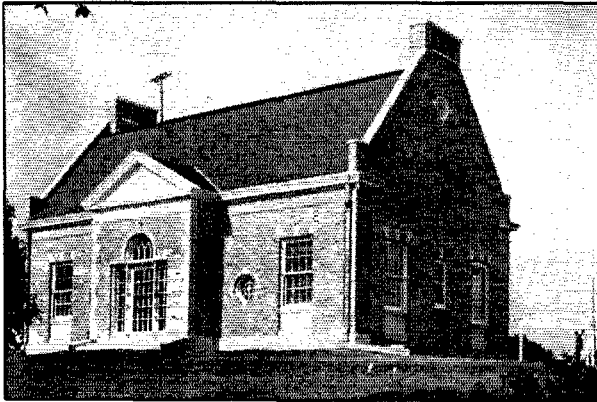

THE MAXIM MEMORIAL

The brick-and-stone colonial-style memorial building faces east on Main Street, Newington, Conn., about four miles from the A.R.R.L. offices in West Hartford.

association we know to-day as A.R.R.L. into being. When we speak of that man who defended our hobby, obtained recognition and maintained frequencies for the youthful organization, and whose leadership and vision united the scattered and diverse personalities of transmitting amateurs to form a strong and practical organization we, of course, speak of Hiram Percy Maxim.

On the anniversary of his birthday, September 2nd, the new Memorial Station, WIAW, was dedicated "to Hiram Percy Maxim, Father of Organ-

* A.R.R.L. Communications Mgr.

to an untimely end in the floods of March 1936. Temporary work continued through W1NMF, a small station at the West Hartford offices. In May 1936, at the Board meeting following President Maxim's death in February and the flood loss in March, your Directors determined to build a new and better station to replace W1MK, and to make this station a Memorial to Hiram Percy Maxim, to carry forward his ideals and inspiration. Appropriations totalling \$18,000 were made by the Board for this Memorial, now completed and ready to carry on the work of the amateur

service in the traditional manner.

All amateurs, and Members of the A.R.R.L. particularly, are invited to visit W1AW as well as work the station from their own shacks. W1AW is dedicated to fraternity and service, and available time is divided between different bands and modes for QSO's with Rag Chewer, DXer, Traffic Man, etc. The station will take part in all A.R.R.L. Operating activities, but with its new facilities will not compete with individual members, though results will be given for the information of Members. Many pages of the new visitor's book at W1AW have already been filled, in the period between the inspection of the Board in May

and the official opening September 2nd. Visitors are most welcome at all times when the station is open.

Members who have not yet visited W1AW have been interested in some of the features. Suppose then we travel to W1AW briefly via the pages of *QST*. The station is located in Newington, Conn., about 4½ miles almost directly south of the A.R.R.L. offices in West Hartford. If we call at Hq. we get information on operating-visiting hours and a map that shows us the best way to get there. The station is located about 65 feet back from the highway, center front in the eastern end of a field approximately 370 feet N-S by nearly 900 feet E-W, more than a seven acre area. The first thing we notice will be the call signal W1AW in gold letters in the stone above the entrance of the 26' × 42' building—and the masts and antennas in the field back of the building. There is a parking space 25 feet wide all around the building, so we drive in. We ring the doorbell and as soon as the operator is free from his schedule he makes us welcome.

We pause to read the inscription on the Memorial Tablet which occupies the prominent position in the entrance hall or lobby. The room is not ornate or large, but one is properly impressed by



PRESIDENT WOODRUFF UNVEILS THE MEMORIAL TABLET

Dr. Eugene C. Woodruff, WSCMP, A.R.R.L. President, is shown in the act of unveiling the Memorial Tablet at the W1AW dedication ceremonies, September 2nd.

the simplicity and dignity of the design. The operator explains that the building is wholly utilitarian except for this room, and we pass into a "visitors'" room at the right. Equipped with a chair, divan, table and ash trays we can make ourselves right at home with the latest *QST*, or pause to chat with other guests without disturbing operating that may be in progress in the adjoining room. A "radio operating" action picture of Mr. Maxim catches our attention. The room also contains an album with a complete pictorial record of the construction of this station and interesting historical photographs of its predecessors. There will be a similar album of QSL's, and exhibits of sta-

tion awards, log books and other information of interest soon on tap. Since our time is limited we pass on into the operating room after a quick peek at the work shop.

Tools and parts are in evidence here, as the operators are completing some new units for five- and ten-meter work, and marker frequency work. Daily schedules and tests on all bands to check on the characteristics of the new antennas are in progress. Everything has been carefully and systematically put together, and the new units authorized at last May's meeting of the Board will be added over the next season in just the same fashion. The station went into full operation in early September with the exception of these newly authorized things.

The station bulletin board is in the work shop. We note a copy of the latest Official Broadcast for the news that is current and of national significance. We also see just how the station operation is being expanded during September and October, so that by the middle of that month it will be on the air close to 12 hours per day.

But we pass along to the operating room—a sort of amateur's dream. One of the photographs with this article gives a rough idea! Transmitter after transmitter is in the front of the room—three



THE OPERATING ROOM AT WIAW

Each transmitter is completely self-contained. L. to R. across back of room: 28 Mc., 14 Mc., 7 Mc., 500-watt modulator, 3.5 Mc., and 1.75 Mc. Chief Operator Harold A. Bubb is seated at the control desk.

pairs of transmitters with room to pass between or work on each! The operating desk carries the receiver, mike, keys, speech-limiter, message-file and controls. Beside the desk there are two other rack-and-panel units, likewise in neat dust covers. The walls have convenient maps of the U.S.A. and the world. O.R.S., O.P.S. and O.B.S. certificates indicate the service, work and high standards of the operating program. Left to right in the front of the room, the racks contain: The completed portion of the 28-Mc. transmitter, the 14-Mc. transmitter, the 7-Mc. transmitter, the 500 watt modulator (switchable to any set), the 3.5-Mc. transmitter, the 1.8-Mc. transmitter. All the transmitters are kilowatt jobs. Room is provided in the modulator rack for installation of a medium power 56-Mc. transmitter. A table back of the operator carries the perforator for punching out tapes for the constant-speed transmissions of the "automatic." The tube line-ups are as follows:

- 1.7 Mc.: 47-RK28-204A's, P.P.
- 3.5 Mc.: 89-6L6-RK48-EK 354's P.P.
- 7 Mc.: 6L6-RK20-HF200's P.P.
- 14 Mc.: 89-807-35T's P.P., Eimac 250TH's, P.P.
- 28-30 Mc.: 89-807-814's P.P., 806 P.P.
- Speech Amplifier, Signal-Limiting Volume-Compressor and
- Modulator: 6J7, 6C5-6J7 6L7-6H6-6C5's P.P., 6L6's P.P., Taylor 822's P.P.

Power provisions permit balancing load on each side of the 220 v. line by allocation of filament or plate circuits of each unit to different sides of the line. There is a special

two-outlet 110-volt line, independently fused, that runs to each transmitter to facilitate repair work, use of soldering iron, etc. when the power circuit is dead or automatically disconnected by interlocks. All leads come up through floor conduits within the dust covers and in the back of each transmitter.

Each of the five transmitter units has its individual power supply. Each can be run individually, or simultaneously, for telegraph transmissions. Each transmitter has an individual 72-inch-high metal rack and dust cover. Pilot lights indicate "live" transmitters, and any transmitter can be controlled directly from the desk.

Conduits under the floor bring all control leads to the desk, and relays switch on power, or switch antennas, or switch the rhombic antenna from send-to-receive, if desired.

PHONE PROVISIONS

Pilot lights also indicate by inspection which transmitter is connected to the modulator. This is quickly switchable manually to the desired band. An oscilloscope in the station provides for checking modulation adjustments. The volume-compressor speech-limiter circuit is simple and inexpensive and something that every telephone amateur ought to consider essential to the good performance of his station. The "mike" is directive, and so is efficient for communication with the

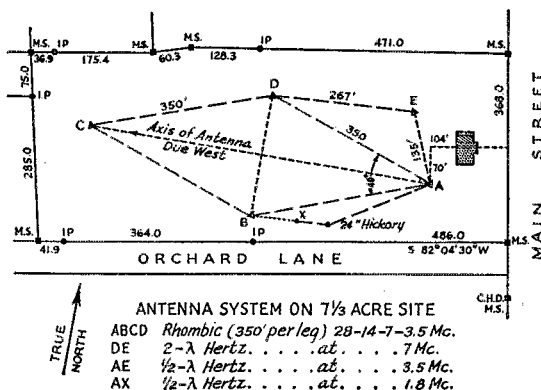

minimum of background conversation and room echo.

Every transmitter is designed for break-in operation! The buffer stages are all provided with links which will later receive excitation from oven and temperature-controlled Bliley BC-10 units that will operate close to particular band edges at particular times in a marker-frequency program to be inaugurated some time in the future. The 4-Mc. set can be used in emergencies as e.c.o. controlled, though it is normally crystal controlled. Power for the station is independent of the Hartford utility company that suffered interruptions of service in 1936 floods. The station is some miles from the river insuring safety from this hazard, and power from C. L. & P. Co. to the vicinity was supplied uninterrupted to this community at that crucial time.

OPERATORS

While different members of the A.R.R.L. staff may work you from W1AW on occasion, the most regular operation is by the men who take care of the building and show us its facilities. Mr. Harold Bubbs (Hal—W1JTD) is the first operator and responsible for the fine construction of the units. He can tell you of experiences at old W1MK, too. Mr. George Hart (Geo—W3AMR) is a new addition to the Hq. staff and likewise a first-class operator in every respect. He comes to us from W3NF and W8YA and will be no stranger to those who have worked those stations on 'phone and c.w. in the past.

OBS SCHEDULE

The station now observes the following regular Official Broadcast schedules:

Frequencies	Starting times (P.M.)	Speeds (W.P.M.)
C.W.: 1800.5-3825-7150-14254 kc.		
	EST CST MST PST	M T W Th Fri
	8:30 7:30 6:30 5:30	20 15 25 15 20
	Midnight 11:00 10:00 9:00	15 25 15 20 15

'Phone:

Each code transmission will be followed in turn by voice transmission:

1808
3950
14,240 kc.

General Operation: Following completion of the early evening (8:30 EST) transmissions on each frequency as above indicated, W1AW will operate on different bands in turn each night of regular operation until the time for transmission of the midnight *QST* (Official Broadcast). A more complete and expanded "general" time schedule of the station will be given in *QST* next month.

We have looked over the straightforward con-

struction of each transmitter and now are curious about getting the r.f. to the antennas, there being several feet between antenna networks and transmitters for working on equipment. A unique arrangement takes care of this nicely. A formica tube on the top of each transmitter runs back to a shelf across the back of the room. This tube is the mechanical control for tuning the antenna condenser, and it also carries the "link" wires that carry the r.f. power inside the tube in addition. Thus long leads below the floor and attendant losses are avoided.

Back of the six transmitter units are six windows and six plate glass transoms above them and the shelf. All lead-ins come through brass rods spaced in the plate glass—a more efficient system, also less expensive than special bushings. The

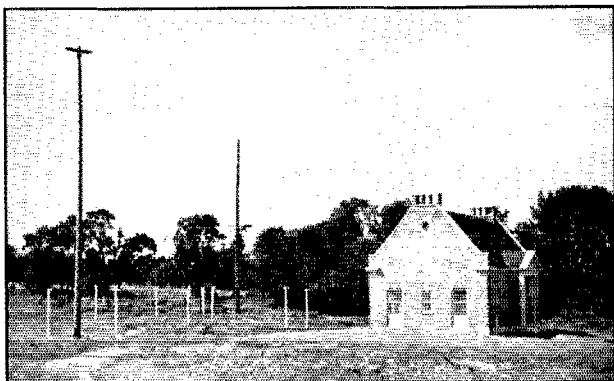

W1AW FROM THE SOUTH

This view shows two of the five 65-ft. masts which support the five antennas of various types. Note the 14-ft. high sticks supporting the feeder lines, which enter the building at the rear.

operator tells us that each of the transmitters has its own antenna, as well it may, with seven acres of field back of the station. The shelf contains *L-C* circuits tuning to each transmitter band. The coils are of bare conductor with taps provided to make it possible to match almost any desired feed line impedance. A heavy plug-jack system is used to make possible interchange of antennas between transmitters when necessary, and most particularly to make the excellent west-directivity of the "diamond" available for work as low as 3.5 Mc. as well as up to and including the 23-Mc. band. This system makes grounding the antennas just a simple proposition of plug-and-jack. In theory this *L-C* arrangement for matching to the impedance of any feed line is ideal. However the operator tells us that in practice the impedance is changing rapidly as the feed line goes through a current loop so that a suitable amount of loading has been added to some of the resonant feed lines on the lower frequencies, to make it possible to load the sets to their maximum permitted outputs

(Continued on page 78)

A Low-Cost Single-Signal Receiver

Double Regeneration for I.F. Selectivity and Image Reduction

By George Grammer,* W1DF

THERE is no doubt that with amateur activity at its present height something considerably better than the t.r.f. receiver is not only desirable but essential. But recognition of that self-evident fact does not give material aid to the fellow with a t.r.f. pocketbook. Something more concrete than sympathy is needed—to wit, suggestions for what to do about it. We propose to offer some herein, in the form of a description of a superhet which will do a real single-signal job, but which costs little if any more than the average t.r.f. set—maybe less. Figures prove the case, and we rest ours on the fact that the receiver pictured here can be built for \$21, plus approximately \$4.50 for the six tubes used in it. It is a ham-band outfit, using plug-in coils adjusted so that each band is spread over practically the whole dial range. What you get out of it depends to some extent on how

The circuit, shown in Fig. 1, will not be hard to follow by anyone having an understanding of the operation of a superhet receiver. The mixer, a 6L7, is coupled to the antenna. To reduce image response and provide additional gain, this stage is made regenerative. The oscillator is 6J5 triode, one of the most satisfactory types for this purpose. There is a single i.f. stage, using a 6K7 and iron-core transformers. The second detector is a 6C5 operated as a plate rectifier to handle large signals and to provide good headphone output; this type of operation, incidentally, does not load the i.f. transformer and hence better overall selectivity results than when a diode detector is used. The audio output tube is a 6F6. A 6C5 beat oscillator completes the tube complement. Metal tubes were used throughout because they are self-shielding and thus eliminate the need for extra tube shields. Although not indicated on the circuit diagram, the i.f. amplifier is made regenerative by a very simple method to give the single-signal effect.

Taking the circuit features individually, the mixer stage uses the familiar tickler circuit to obtain regeneration. This method was used in preference to the popular cathode-tap arrangement for three reasons: First, it is much easier to change the number of turns on a separate coil in making preliminary adjustments than it is to move a tap; second, the possibility of hum, always likely to be present in regenerative circuits using 6-volt tubes, is lessened by having the cathode at ground potential for r.f.; third, with the cathode grounded it is less likely that any oscillator voltage will appear in the mixer grid circuit. The appearance of oscillator voltage on the No. 1 grid of the mixer is not only undesirable from the standpoint of tube performance, but also, since in this case the mixer works directly from the antenna, is likely to bring in unwanted

signals. This is particularly so on the lower-frequency bands, where high-frequency commercial signals can be picked up on oscillator harmonics.

To avoid constructional complications, the mixer tuning is not ganged with the oscillator.

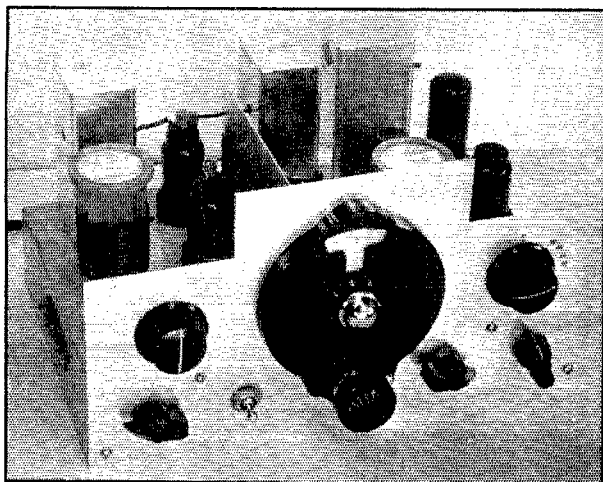

THIS SIX-TUBE S.S. RECEIVER CAN BE BUILT FOR ABOUT TWENTY-FIVE DOLLARS, WITH TUBES

A regenerative i.f. stage gives single-signal selectivity; a regenerative mixer is used to provide good signal-to-image ratio. Power supply requirements are 2.1 amperes at 6.3 volts, and 60 milliamperes d.c. at 200-250 volts, for loud-speaker operation.

intelligently you use it—but then, that is also true of high-priced receivers. It is quite easy to build and put into operation, with only one original adjustment which requires more than ordinary care.

* Asst. Technical Editor, QST.

Although this might seem a disadvantage, in that the two circuits must be tuned separately, in practice it has not turned out to be so. In fact, the mixer tuning condenser, C_1 , makes a quite effective volume control, and for c.w. reception in particular its use in this fashion is quite advantageous. The regeneration control is a variable resistor, R_2 , in series with the 6L7 cathode resistor.

In the high-frequency oscillator the tickler circuit again is used, the reason being to keep the cathode at ground potential to reduce hum. Our previous experience with 6-volt oscillators using the cathode-tap circuit has been none too good—all of them were only too prone to turn "r.a.c." on 14 Mc. and practically refused under any circumstances to be "d.c." on 28 Mc. Results so far with this receiver have justified grounding the cathode. Band-spread is by the usual tap method, C_3 being the tuning condenser and C_2 the band-setting trimmer. The oscillator grid is coupled to the No. 3 grid of the 6L7 through a small trimmer condenser, C_5 .

The i.f. stage as shown in the diagram is quite conventional. Its gain is controlled by R_4 , which

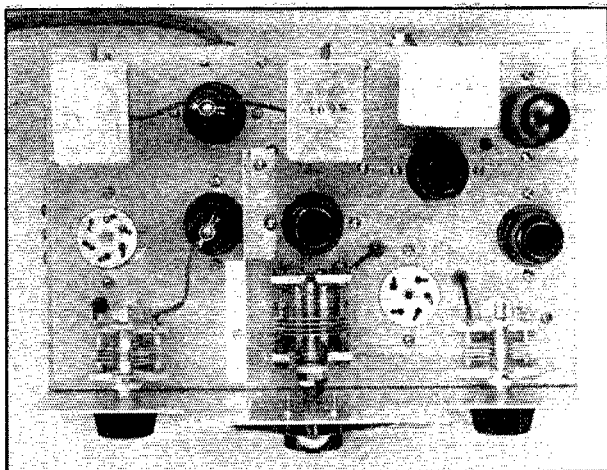

THE TUBES AND MOST R.F. COMPONENTS ARE PLAINLY SHOW IN THIS PLAN VIEW

The location of various parts is discussed in the text. The i.f. transformers are permeability-tuned, with high-stability fixed mica condensers. Any type of air-tuned iron-core transformer may be used instead.

varies the control-grid bias. The stage is made regenerative by simply running a short length of insulated wire from the control grid of the 6K7 through a hole in the shield can of i.f. transformer T_2 so that a small amount of energy is coupled back to the grid from the plate. When

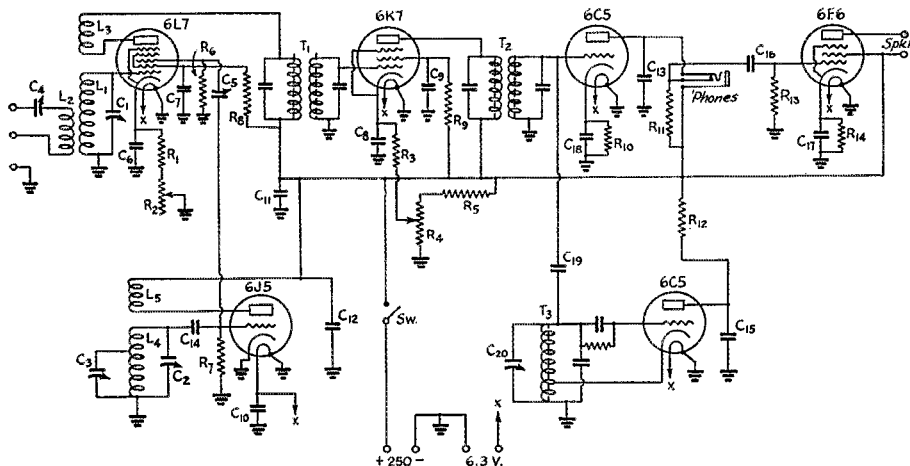
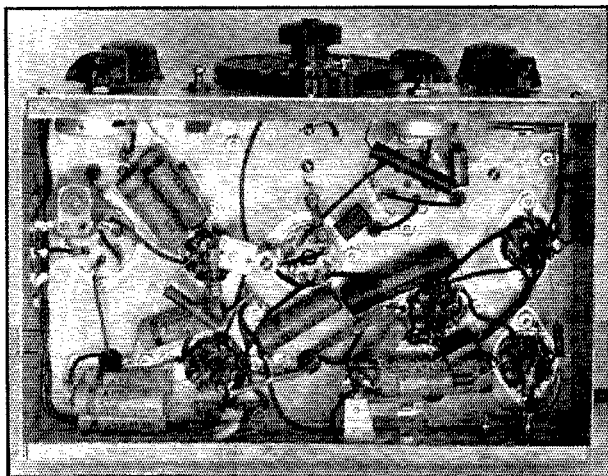

FIG. 1—CIRCUIT DIAGRAM OF THE REGENERATIVE S.S. RECEIVER

C_1, C_2 —50- μ fd. variable (Hammarlund MC-50-S).
 C_3 —35- μ fd. variable (National SS-35).
 C_4 —70- μ fd. mica trimmer (Hammarlund BBT-70).
 C_5 —30- μ fd. Isolantite-insulated mica trimmer (National M-30).
 C_6, C_{10} , inc.—0.1- μ fd. paper, 400-volt.
 C_{11} —0.2- μ fd. paper, 400-volt (or larger).
 C_{12}, C_{13} —0.005- μ fd. mica.
 C_{14} —100- μ fd. mica.
 C_{15}, C_{16} —0.01- μ fd. paper, 400-volt.

C_{17} —10- μ fd. 25-volt electrolytic.
 C_{18} —5- μ fd. 25-volt electrolytic.
 C_{19} —See text.
 C_{20} —25- μ fd. variable (Hammarlund SM-25).
 R_1 —300 ohms, 1/2-watt (see text).
 R_2 —500-ohm variable, wire-wound.
 R_3 —300 ohms, 1/2-watt.
 R_4 —25,000-ohm volume control.
 R_5 —50,000 ohms, 2-watt.
 R_6 —50,000 ohms, 1/2-watt (I.R.C. Type F).
 R_7 —150,000 ohms, 1/2-watt (I.R.C. Type F).

R_8 —12,000 ohms, 1-watt.
 $R_9, R_{10}, R_{11}, R_{12}$ —50,000 ohms, 1/2-watt.
 R_{13} —0.5 megohm, 1/2-watt.
 R_{14} —450 ohms, 1-watt.
 T_1, T_2 —455-kc. interstage-type i.f. transformers (Sickles 6504).
 T_3 —455-kc. beat oscillator transformer, with grid condenser and lead (Sickles 6577).
 L_1, L_5 , inc.—See coil table.
 Jack—Double-circuit type.
 Sw—S.p.s.t. toggle.



BELOW CHASSIS—CHIEFLY BY-PASS CONDENSERS AND RESISTORS

this is done R_4 serves as a regeneration control and is more effective in varying the selectivity than gain. If the high selectivity afforded by regeneration is not wanted, the regenerative coupling may be omitted and the set becomes a straight super insofar as the i.f. is concerned.

The second detector, beat oscillator and power amplifier need no special comment. The headphones plug into the plate circuit of the second detector; the signal level is quite high here and no additional audio amplification is needed. For simplicity, no audio gain control is incorporated in the set, since the various r.f. controls afford quite a range in volume

LAYOUT

The various photographs show the layout, both top and bottom, quite plainly. The chassis is a standard item measuring 11 by 7 by 2 inches. The band-spread tuning condenser, C_3 , is at the front center, operated by the vernier dial. At the left is C_1 , the mixer tuning condenser, and at the right, C_2 , the oscillator band-setting condenser. The oscillator tube is directly behind C_3 , with the mixer tube to the left on the other side of a baffle shield which separates the two r.f. sections. This shield, measuring $3\frac{3}{4}$ by $4\frac{3}{4}$ inches, is quite effective in preventing unwanted coupling between oscillator and mixer. The mixer coil socket is at the left edge of the chassis behind C_1 ; the oscillator coil socket is between C_2 and C_3 .

The i.f. and audio sections are along the rear edge of the chassis. The transformer in the rear left corner is T_1 ; next to it is the i.f. tube, then T_2 . The transformers are mounted so that the adjusting screws project to the rear where they are easily accessible. With the particular type of transformer used this requires drilling a new hole in the shield of T_1 so that the grid lead to the 6K7

can be brought out the proper side. In T_2 , the grid lead should be pulled through the side of the can and brought out the bottom with the other leads, since the grid of the 6C5 second detector comes through the base.

The transformer at the rear right is for the beat oscillator. The 6C5 second detector is directly in front of it and the beat oscillator tube is about midway along the right chassis edge. The 6F6 output tube is in the rear right-hand corner.

Power cord, headphone jack (insulated from the chassis) and a tip jack for the speaker are on the rear edge of the chassis. The antenna input terminals are on the left edge, near the mixer coil socket.

The controls along the bottom edge of the panel are, from left to right, the mixer regeneration control, R_2 , the on-off switch, Sw , the i.f. gain or regeneration control, R_4 , and the beat-oscillator vernier condenser, C_{20} . The latter has the corner of one rotary plate bent over so that when the condenser plates are fully interleaved the condenser is short-circuited, thus stopping oscillation.

WIRING POINTERS

Study of the bottom view will show how the various resistors and by-passes are wired in. The tube sockets are bakelite except that for the high-frequency oscillator, which is Isolantite. The coil sockets also are Isolantite, a six-prong socket being used for the mixer coil and a five-prong unit for the oscillator. In most cases the various components can be mounted by their wire leads, but one or two insulated lugs will be needed for "B" connections.

As shown in Fig. 1, one side of the heater circuit is grounded, so that only one filament wire need be run from tube to tube. The more conventional method of running heater current through a twisted pair can be used if preferred. The method indicated has proved to be quite satisfactory, however, in that it does not seem to introduce any particular hum. On each tube socket the shield prong and adjacent heater prong are tied together and grounded.

In making ground connections the practice of bringing all by-pass condenser returns for each individual stage to a single point has been followed when possible, the cathode ground (through the by-pass condenser, when used) being the focal point. In some cases, where long return leads would have been necessary, separate grounds are used on the same stage. If desired, such grounds can be tied together with heavy wire, but since no instability resulted without them they were not used in this case. In any event,

it seems desirable to make the r.f. path from cathode to chassis as short as possible, as a fundamental requirement.

The oscillator-mixer coupling condenser, C_5 is mounted from one of its connection tabs on a small ceramic pillar (furnished with one of the tube sockets) between the oscillator and mixer tube sockets. The antenna series condenser, C_4 , also visible in the bottom view, is mounted between one terminal on the antenna strip and one of the mixer coil-socket prongs. These condensers do not require readjustment in normal operation, hence are screw-driver adjusted from the bottom.

The i.f. plate by-pass condenser, C_{11} , actually consists of two 0.1- μ fd. units in parallel. A minimum of 0.2 μ fd. was found necessary to prevent i.f. instability, but any convenient larger value can be used, or a single unit of the proper capacity may be substituted.

In doing the actual wiring, it will be found convenient to start with the filaments and follow with all the by-passes and resistors, leaving the r.f. until last. This method makes it possible to find room for the larger parts first and thus avoids any re-wiring if things don't fit right toward the end of the job. It also keeps the condensers close to the chassis and leaves the r.f. wiring out in the open.

The grid and plate leads from T_2 are covered with shield braid to help prevent coupling back to T_1 . This precaution probably is not necessary, but may mean avoiding unwanted i.f. oscillation.

The b.o. coupling condenser, C_{19} , is not an actual condenser unit but is simply the capacity existing between the grid prong on the 6C5 socket and the adjacent prong on the side away from the plate. This prong, ordinarily unused, is connected to the b.o. as shown; more conveniently, it may be connected directly to the grid of the

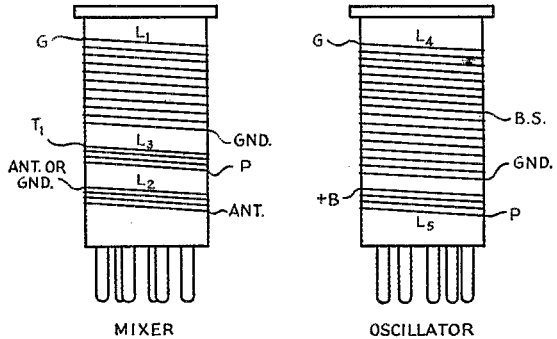

FIG. 2—THIS DRAWING SHOWS THE METHOD OF WINDING THE MIXER AND OSCILLATOR COILS
All coils are wound in the same direction.

b.o. tube with identical results. This coupling puts a rather strong beat voltage at the grid of the second detector; sufficient coupling was used so that strong signals give loud audio response. If a weaker beat signal is wanted, the coupling should be from the cathode of the b.o. tube.

R_1 , the fixed cathode resistor in the 6L7 circuit, is an adjustable unit furnished with R_2 . It was set to 300 ohms before installation.

COIL DATA

Band	Coil	Wire Size	Turns	Length	Tap
1.75 Mc.	L_1	24	70	Close-wound	—
	L_2	24	10	"	—
	L_3	24	3.5	"	—
	L_4	22	42	"	Top
3.5 Mc.	L_5	22	8	"	—
	L_1	22	35	"	—
	L_2	22	7	"	—
	L_3	22	2.5	"	—
7 Mc.	L_4	22	25	1 inch	17
	L_5	22	5	Close-wound	—
	L_1	18	20	1 inch	—
	L_2	22	4	Close-wound	—
14 Mc.	L_3	22	2	"	—
	L_4	18	13	1 inch	6
	L_5	22	3	Close-wound	—
	L_1	18	11	1 inch	—
28 Mc.	L_2	22	4	Close-wound	—
	L_3	22	2.5	"	—
	L_4	18	7	1 inch	2.4
	L_5	22	2	Close-wound	—
35 Mc.	L_1	18	5	1 inch	—
	L_2	22	3	Close-wound	—
	L_3	22	2.5	"	—
	L_4	18	3.6	1 inch	1.3
	L_5	22	1.4	Close-wound	—

All coils $1\frac{1}{4}$ inches in diameter, on Hammarlund SWF forms. Spacing between coils on same form approximately $\frac{1}{8}$ inch. Band-spread taps are measured from bottom (ground) end of L_4 . All coils are wound with enamelled wire.

COILS

The method of winding coils is shown in Fig. 2, and complete specifications are given in the table. All windings are in the same direction. With connections brought out as shown, reversing L_3 with respect to L_1 , or L_5 with respect to L_4 , will prevent oscillation.

In Fig. 1, the ticklers, L_3 and L_5 , have been shown coupled to the grid ends of L_1 and L_4 , respectively. This was done purely to make the diagram less awkward; the actual method of construction is given in Fig. 2, with the ticklers coupled to the grounded ends of the grid coils.

The specifications given should be followed rather closely in the case of L_4 if complete band-spread is to be obtained in each band. The tickler, L_5 , is not so critical; use enough so that the tube oscillates readily with fairly low plate current, but not so much as to cause blocking. There is a good deal of leeway in the case of L_1 , since the tuning condenser has sufficient range to compensate for moderate changes in the inductance of this coil. The tickler coil L_3 , however, is another story, and it may be necessary to "tailor" it to fit the antenna. It must be large enough to make the mixer circuit oscillate readily, but yet not

so large that oscillation continues over the whole range of R_2 . The desirable condition is that of having the circuit go into oscillation when the optimum bias, approximately six volts, is applied to the 6L7. The number of turns on L_3 , or the coupling between L_3 and L_1 , should be adjusted so that the mixer goes into oscillation with R_2 set at about half scale. The antenna coupling condenser, C_4 , affords some compensation for the antenna loading effect, and is particularly useful on the higher frequencies where the number of turns is small and the adjustment therefore more critical.

Where spaced windings are called for, the turns may be spaced by hand or by winding small wire or thread between them. After the windings are finished they may be held permanently in place by Duco cement spread along the coil-form ridges. After soldering the coil ends in the pins, be sure to clean off any rosin which may have formed a thin film over the contact surfaces.

Any convenient pin-connection arrangement may be used. Make the connections so that the shortest leads between coil socket and circuit points result.

I.F. ALIGNMENT

The i.f. alignment procedure is an oft-told story and probably does not need too detailed treatment here. Undoubtedly the most difficult feature is that of securing proper equipment for the job, but a service-man friend or the local parts store may be able to help out. A test oscillator and 0-1 milliammeter make a suitable combination. The i.f. should be aligned without the regenerative connection and with the h.f. oscillator coil out of its socket. A mixer coil may be in place in order to complete the 6L7 plate connection; without the coil it is necessary to connect a jumper across the L_3 prongs on the coil socket. Incidentally, if no speaker is used either the speaker terminals must be short-circuited to prevent damage to the 6F6, or else the tube must be out of its socket.

Connect the test oscillator output between the 6L7 grid and chassis, with the normal grid connection to C_1 removed. Hook the milliammeter to a 'phone plug and insert plug in the head-phone jack. Set the oscillator to 455 kc. and adjust the trimmers on T_1 and T_2 to give maximum meter reading, with R_4 set for maximum gain or slightly below. The beat oscillator should be off. Without signal the second detector plate current should be between 0.1 and 0.2 ma.; adjust the test oscillator output so that the reading with signal is about 0.4 or 0.5 ma. As the circuits come into line, reduce the signal input to keep the reading about the same. Line up the circuit as accurately as possible, since correct alignment helps both gain and selectivity. If the i.f. is unstable, the meter will not show a smooth rise and fall through maximum as a circuit is adjusted but will be jumpy, probably to full scale or more if oscillations start. There should be no trouble on this account if adequate by-passing and reasonable circuit isolation are employed.

If no 0-1 milliammeter is at hand a fair alignment job can be done by ear. Using a modulated test oscillator, peak all the trimmers for maximum audio output, using a fairly weak input signal for the final adjustment. With a little practice an equally good result can be obtained even without modulation on the oscillator, careful attention being paid to the change in character of the hiss as the circuit is tuned through resonance.

If no regular test oscillator is available, the beat oscillator can be used as a substitute, preferably set up temporarily in a separate unit. The output can be taken, in many cases, without formal coupling, the oscillator simply being on the same table as the receiver. A resistor of several thousand ohms should be connected between the 6L7 grid and ground to complete the d.c. grid circuit and give some impedance for the i.f. The beat oscillator can be set to the correct frequency by coupling it to a broadcast receiver and adjusting the tuning so that its 2nd and 3rd har-

(Continued on page 80)

Next Month—National Convention Story

CLICK-CLACKING train wheels punctuate the echo of tootled c.w. from "2-lung-power" whistles as we head homeward from the Chicago National A.R.R.L. Convention—the greatest amateur convention ever held, bar none. We had hoped to bat out a hurried story of the convention activities that would "make" this issue of *QST*, despite the stern fact that final press date was but two days after the convention ended. But now we know that can't be done—the affair was too big, too spectacular to be jammed into any hurriedly-written piece. The wealth of color and incident that characterized this convention is only hinted when we repeat that it was half again as large as any held heretofore—and set a faster pace, with more going on, than anything we have known. So pardon our enthusiasm until next month, when we will hope to weave all the threads into a detailed account worthy of amateur radio's greatest gathering of all time.

Amateurs Aid Hughes on World Flight

EVERYONE is familiar with the recent record-breaking round-the-world flight of Howard Hughes and his associates in their special Lockheed plane, but not so well known is the story of the radio activity behind the achievement. Amateur radio played an important part—not in the sense that amateurs throughout the world participated in the communication, but because three outstanding amateurs contributed a great deal to the success of the radio contacts.

It was of course necessary that absolutely reliable contact be available with the plane at any time, so that the all-important weather data could be transmitted from the flight headquarters at the New York World's Fair grounds, and also so that engineering data could be exchanged. The marked success of the radio communication tells its own story of the effectiveness of the preparations.

Charles Perrine, W6CUH, Hughes' ground radio chief and assistant to Richard R. Stoddart, was responsible for much of the ship's installation and also was in charge of the ground network. This network consisted of W2GOQ, remotely-controlled from flight headquarters at the New York World's Fair; W2UK, operated by "Tommy" Thomas at Quogue, L. I.; and W6CUH at Hermosa Beach, Calif., operated by Dave Evans, W4DHz. All three stations operated on either 7,000 or 14,000 kc. exactly, a system which worked out beautifully because any of the three stations could work the plane without Stoddart having to touch his receiver and, since each amateur station was using two receivers, the ground stations could intercommunicate without difficulty. Several times messages received at one of the stations were relayed to the headquarters station less than one minute later. Beam antennas used at the amateur stations were so positioned that the plane was usually on the line of at least one of them.

The arrangements for weather forecasting also hinged on the effectiveness of the radio circuit. William C. Rockefeller, one of the country's foremost meteorologists, undertook the gigantic task of charting and predicting weather over the full

course of the flight. In order to do this (which has never been done before) it was necessary to receive weather reports from London, Berlin, Paris, Rome, Moscow, Manila, Honolulu, San Francisco and Arlington, for complete coverage. An idea of the extent of this data can be gained from the transmissions that were copied each day from Moscow in order to provide a single forecast for one leg of the trip in Russian territory. The transmission from Moscow, lasting one hour and twenty minutes, was comprised of over 250 stations in Russia and Siberia alone, with a total of over 10,000 numbers recorded, all representing certain items of weather information and coded in the standard international weather code. The collection of the weather data required about six hours each day of nearly steady copying (at about 30 w.p.m.) by the operators at W2GOQ, with W2UK standing by at all times in case of local QRN. It then took another two or three hours to finish compiling the data and make the forecasts.

The regular amateur transmitters were employed at the ground stations, with two HRO receivers in use at each station. Four HRO's were required to do the job at W2GOQ, Flight Headquarters. Aboard the plane, the complete installation was designed for ruggedness and, in the event of failure duplicate equipment was immediately available. The main transmitter was a 100-watt affair built by the Hughes Aircraft Company, designed for A1, A2 and A3 transmission. Eighteen different crystal-controlled frequencies were

almost instantly available, ranging from 333 to 23,100 kc. The second transmitter (a Bendix) was also of 100-watt power with 8 frequencies, duplicating certain of the frequencies used in the other rig. It was intended for use in case of failure in the main transmitter.

A complete emergency station was also incorporated. This consisted

of a 15-watt c.w. transmitter incorporating four crystal frequencies from 500 to 16,000 kc. and a receiver with a similar range. Power could be obtained from a hand-driven generator or batteries. The complete emergency station, including key, headphones and antenna, was contained in a waterproof container 15" × 8" × 10". A kite and a



EVANS AT
W6CUH



PERRINE AT
W2GOQ



THOMAS AT W2UK

balloon were available to raise the antenna in case no other support was available.

The receivers were two Bendix superheterodynes covering both low and high frequencies for general communication and for use with the Bendix loop unit, the emergency receiver already mentioned, and a Fairchild loop receiver used with the Kruesi radio compass.

An electric reel for letting out the trailing antenna was located in the tail of the ship and controlled from the operating position. It was fed through a 100-ohm concentric line provided with a novel means of indicating to the operator when the antenna length was correct and a perfect match obtained. The antenna could of course be made practically any odd number of quarter waves long on the higher frequencies, and the directivity characteristics of long-wire antennas were employed to boost the signal at various times. The antenna was completely clear of the ship, the concentric line extending right out through the tail cone.

—B. G.

W2LXY and VR6AY Receive Public Service Certificates

BY order of the Executive Committee of the A.R.R.L., Public Service Certificates were issued on August 12th to Mrs. Dorothy Hall, W2LXY, and Andrew Young, VR6AY for "meritorious radio contact work in connection with the threatened isolation of Pitcairn Islanders, due to rumored epidemic. The above work . . . took place on schedule during several consecutive days of the latter part of July, 1938."

Mrs. Hall has been credited widely in the press and over the broadcast chains for having averted what might have been a serious condition on the island. The full story can best be taken from her log.

W2LXY has been scheduling VR6AY every other day since early May, handling a number of messages to and from the island. In the latter part of May, Andrew Young, operator of VR6AY, made mention that ships had neither stopped or called him by radio, and in June he said that he had learned that it was probably due to a false rumor of typhoid on the island. At Young's request, Mrs. Hall sent a message to the shipping agents at Balboa, C. Z., assuring them that all were well on Pitcairn and that boats could stop. This message was acknowledged.

On July 19th Young said that no boat had stopped since May 25th and the islanders were then short of provisions, medical supplies and gasoline, and were dependent on the wind-driven generator for their radio power. Mrs. Hall then wrote to the British Consulate General in New York to inform him of the condition.

On July 22nd Douglas Williams, an American correspondent for the *London Daily Telegraph*, came to W2LXY and spoke for over an hour with Young and Richard Christian, chief magistrate of the island, via radio, checking on the island conditions and Mrs. Hall's reports. Williams promised to do all he could to help.

On July 25th Miss Emily McCoy, sister of Richard Christian's wife, spoke with the islanders via W2LXY and found that the typhoid rumor had been started by a New Zealander who had lived on Pitcairn for ten years. This man had told a ship's doctor that there was typhoid and the doctor had not bothered to confirm the story before reporting the typhoid.

Meanwhile the British Consulate reported that they had cabled to the High Commissioner at Fiji but with no result. Williams reported that the Colonial Office was investigating, but when no results were forthcoming, Mrs. Hall cabled to Prime Minister Chamberlain and telegraphed to President Roosevelt with pleas for action.

On July 27th, N.B.C. and the B.B.C. rebroadcast a QSO between W2LXY and VR6AY, after permission had been obtained from the F.C.C. The QSO took place from 11:30 P.M. to midnight, E.S.T. Another contact was made at 4 A.M., at which time Young told Mrs. Hall that the New Zealand steamer *Akaro* had called and was stopping within two hours. On their next schedule, Young reported that the ship had left 12 sacks of flour but no medical supplies.

The *Akaro* finally arrived in Panama, whereupon the captain killed the rumor that there was typhoid on Pitcairn. This information was cabled to New Zealand and the promise was made that full supplies would leave for Pitcairn on August 20th.

—B. G.

Massachusetts State Convention

(N. E. Division)

Boston, Mass., October 15th

COME to the Hotel Bradford, in Boston, October 17th, and see what the Eastern Mass. and South Shore Amateur Radio Clubs have in store for you at this joint Boston Hamfest and A.R.R.L. Mass. State Convention.

A good array of speakers, lots of prizes, contests, meetings and a real Turkey Supper with all the fixings.

Demonstrations and Display Booths.

Registration \$1.00 and this will entitle you to one chance for a prize.

Banquet and registration \$2.50; entitles you to three chances for a prize.

For tickets or information write to Frank L. Baker, Jr., W1ALP, 233 Atlantic St., Quincy, Mass.

Building Television Receivers With Standard Cathode-Ray Tubes

Part I—Scanning, Synchronizing and Power Supply Circuits for One-Inch, Two-Inch and Three-Inch Tubes

By J. B. Sherman*

The articles by Marshall P. Wilder in QST, November, 1937, to May, 1938 constitute the first comprehensive treatment of modern television published in this country. Since their publication we have been able to gain an estimate of the widespread interest in the subject of television by amateurs everywhere and now are pleased to present this article as the first of a second series. An appropriate title for this treatment (and Part II to follow) would have been "Television for Thin Pocketbooks." It is aimed to fill the demand expressed by amateurs for simple equipment with which they can begin experimental work with an absolute minimum of expense.—EDITOR

BEFORE discussing the construction of apparatus for television reception, it may be well to review briefly the essential elements of a television receiver. Fig. 1 shows a block diagram of these elements. The total frequency band, including both sound and picture carriers, is handled in the r.f. first detector, and oscillator circuits. The intermediate-frequency output of the first detector is then fed both to an i.f. amplifier which selects the sound i.f. and rejects the picture i.f., and to an i.f. amplifier

The second detector and video amplifier circuits which follow the picture i.f. and supply the video signal to the cathode-ray grid must likewise satisfy this requirement. The synchronizing impulses are removed from the video signal by an amplitude-separator circuit, and the horizontal and vertical synchronizing impulses are then separated from each other and supplied respectively to the horizontal and vertical scanning circuits, which in turn furnish the cathode-ray deflections.

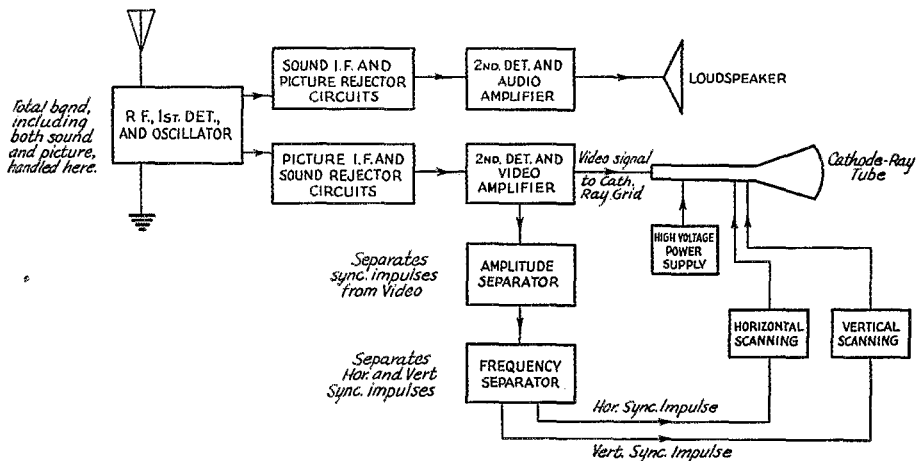

FIG. 1—THE ELEMENTS OF A MODERN TELEVISION RECEIVER

which selects the picture i.f. and rejects the sound i.f. The conventional second detector, a.f. amplifier, and loud speaker complete the sound receiver. The picture i.f. is designed to pass the wide frequency band required for good-quality pictures.

* Research and Engineering Dept., RCA Manufacturing Company, Harrison, N. J.

Thus there is produced on the screen of the cathode-ray tube a moving spot, the brightness of which varies from point to point in accordance with the brightness of the original scanned subject, and so reproduces on the screen an image of the original subject.

The foregoing brief outline of a television re-

ceiving system will serve to refresh the general scheme in the mind of the reader.

Several standard electrostatic-deflection cathode-ray tubes available for oscillograph use afford the amateur the opportunity of constructing television receivers. This article will describe synchronizing, scanning, and power-supply circuits for one-inch, two-inch and three-inch tubes. Later articles will discuss the r.f., i.f., and video amplifiers.

The three oscillograph tubes mentioned are respectively the 913, 902, and 906. It will be appreciated that the picture quality of these tubes cannot equal that of regular kinescopes operating at much higher anode voltages; however, very presentable pictures can be obtained. Some definite figures on resolution obtainable are given below. "Resolution" as used here means the number of parallel lines which, if transmitted, can be distinguished as separate lines in the received picture.

The synchronizing and scanning circuits are the same for the 913, 902, and 906 and are shown in Fig. 2. The power supplies for the outfits are shown in Figs. 3 and 4.

Referring now to Fig. 2, we find a pentode-triode (6F7) which supplies synchronizing impulses from the received signal to gas triodes (884's). These 884's are used as relaxation oscillators to generate the horizontal and vertical sweep voltages. The oscillators feed 6F6 output tubes which furnish the cathode-ray deflecting voltages. It will be noted that the cathode-ray tube has a common connection for the second anode and one deflecting plate of each pair, permitting the use of single output tubes. Ordinarily, when a cathode-ray tube is connected

thus, there is severe distortion of the pattern as well as bad defocusing of the spot. A special deflecting structure in the 906 and 902 greatly reduces both of these difficulties and thus allows considerable simplification of the deflecting circuits.

Tube Type	Screen Size	2nd Anode Voltage	Resolution
913	1"	500	Below 100 lines
902	2"	800	About 150 lines
906	3"	1500	About 250 lines

Let us now consider Fig. 2 in detail. The synchronizing signal, separated from the video signal, consists of high-frequency and low-frequency impulses, both supplied with negative polarity.

These impulses are separated from each other and amplified in the 6F7 tube, the pentode section of which is connected for passage of the high-frequency impulse only and the triode section for passage of the low-frequency impulse only. The impulses leave the 6N7 with positive polarity and are applied to the respective 884 grids. The high- and low-frequency sweep outputs of the 884's are respectively 13,230 and 60 cycles. Coarse as well as fine frequency adjustments are provided to allow for variations among tubes. In use, the fine adjustment should be set to the center of its range, and the frequency set by means of the coarse control, after which the fine adjustment alone will be used. In use, each frequency control is manipulated together with the corresponding synchronizing voltage control, until best stability of the image is obtained.

The 884 oscillator outputs are not perfectly linear sawtooth waves. Adjustment of 6F6 bias gives an excellent means of



PHOTOGRAPHS OF THE IMAGE FROM A MONOSCOPE RECEIVED ON THE 906, 902 AND 913 CATHODE-RAY TUBES AND REPRODUCED AT APPROXIMATELY THE ORIGINAL SIZE

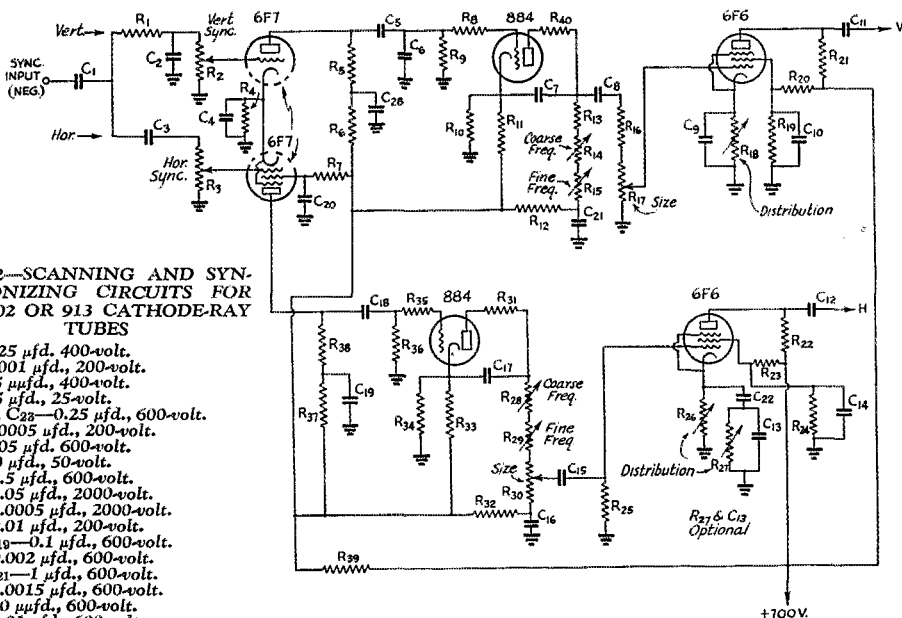

FIG. 2—SCANNING AND SYNCHRONIZING CIRCUITS FOR 906, 902 OR 913 CATHODE-RAY TUBES

- C₁—0.25 μfd., 400-volt.
- C₂—0.001 μfd., 200-volt.
- C₃—25 μfd., 400-volt.
- C₄—25 μfd., 25-volt.
- C₅, C₇, C₂₈—0.25 μfd., 600-volt.
- C₆—0.0005 μfd., 200-volt.
- C₈—0.05 μfd., 600-volt.
- C₉—50 μfd., 50-volt.
- C₁₀—0.5 μfd., 600-volt.
- C₁₁—0.05 μfd., 2000-volt.
- C₁₂—0.0005 μfd., 2000-volt.
- C₁₃—0.01 μfd., 200-volt.
- C₁₄, C₁₉—0.1 μfd., 600-volt.
- C₁₅—0.002 μfd., 600-volt.
- C₁₆, C₂₁—1 μfd., 600-volt.
- C₁₇—0.0015 μfd., 600-volt.
- C₁₈—50 μfd., 600-volt.
- C₂₀—0.01 μfd., 600-volt.
- C₂₂—5 μfd., 50-volt.
- R₁, R₆, R₂₈—0.1 megohm, ½-watt.
- R₂, R₃, R₃₀—0.2-megohm potentiometer.
- R₄—7000 ohms, ½-watt.
- R₅—0.2 megohm, ½-watt.
- R₇, R₂₀—1 megohm, ½-watt.
- R₈, R₃₅—50,000 ohms, ½-watt.
- R₉, R₃₆—0.25 megohm, ½-watt.

- R₁₀—2000 ohms, ½-watt.
- R₁₁, R₃₈—0.15 megohm, 1-watt.
- R₁₂, R₃₂—20,000 ohms, ½-watt.
- R₁₃—0.4 megohm, ½-watt.
- R₁₄, R₁₇—1-megohm potentiometer.
- R₁₅—0.1-megohm potentiometer.
- R₁₆—2 megohms, ½-watt.
- R₁₈, R₂₉—25,000-ohm potentiometer.
- R₁₉, R₂₄, R₂₅—0.5 megohm, ½-watt.

- R₂₁—0.12 megohm, 2-watt.
- R₂₂—25,000 ohms, 10-watt.
- R₂₃—0.1 megohm, 4-watt.
- R₂₆, R₂₇—10,000-ohm potentiometer.
- R₂₈—0.5 megohm potentiometer.
- R₃₁, R₄₀—500 ohms, ½-watt.
- R₃₄—2500 ohms, ½-watt.
- R₃₇—0.15 megohm, ½-watt.
- R₃₈—50,000 ohms, 3-watt.

straightening these. Hence, variable cathode resistors R_{18} and R_{26} are provided for "distribution controls." Linear scanning is had by adjusting the amplitude controls R_{17} and R_{30} together with the corresponding distribution controls. It will probably be found easier to obtain linear vertical than horizontal scanning. The principal difficulty in the horizontal arises from the various circuit capacities which tend to reduce the transmission of the high-frequency components of the sawtooth wave. It must be remembered that a sawtooth wave is made up of a large number of harmonics, of which it is desirable to preserve about 10 if the sawtooth form is to be retained. This means that the 13-ke. sawtooth requires uniform transmission of frequencies up to about 130 kc. For this reason, care should be used in wiring and layout so that the circuit capacities, commencing with the high-frequency 884 plate circuit and going up to the cathode-ray deflecting plates, are as small as possible. Crowding of the picture due to loss of high frequencies in the horizontal sawtooth occurs at the left side of the picture. Should this occur, the insertion of R_{27} and R_{13} will be found helpful in increasing the high-frequency transmission. In practice, it will be found that the blanking signal which, during picture reception, cuts off the cathode-ray tube

for the return of the horizontal sweep, removes a portion of the left side of the scanning field. Hence, some non-linearity at the extreme left can be tolerated and will not appear in the received picture.

At this point the reader will want to know how to check the linearity of the scanning. This can be done quite simply in the following manner. If a signal is applied to the control grid of the cathode-ray tube and one or both scanning oscillators synchronized with this signal, various stationary patterns can be produced on the screen. If in particular a signal of, say, 600-cycle frequency is applied to the cathode-ray grid and the vertical oscillator (60 cycles) is synchronized with this signal, the grid will be driven alternately positive and negative (with respect to its initial bias) ten times during one vertical sweep, and a series of ten bright, stationary, horizontal bars with intervening dark spaces will appear on the screen. If the vertical sweep is linear, the bars will be equally spaced and an actual picture received under this scanning condition would be uniformly spread from top to bottom. Similarly, vertical bars to determine the horizontal distribution can be produced by applying a high frequency between, say, 75 and 150 kc. to the cathode-ray grid and synchronizing the horizontal oscillator

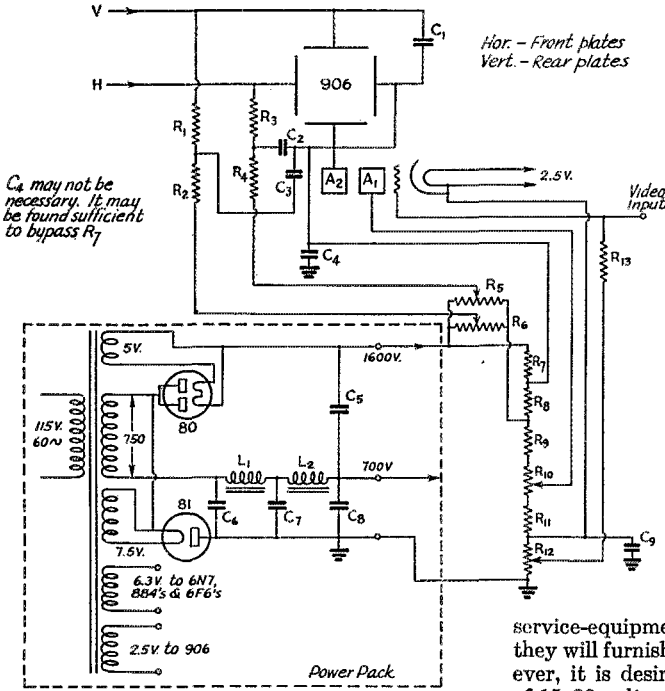

FIG. 3—POWER SUPPLY AND CATHODE-RAY TUBE CONNECTIONS FOR THE 906

Everything except the unit marked "power pack" is built into the same unit as the equipment in Fig. 2.

- C₁—0.001- μ fd. mica.
- C₂, C₃—1 μ fd., 200-volt.
- C₄—0.5 μ fd., 2000-volt.
- C₅—0.5 μ fd., 1000-volt.
- C₆—16 μ fd., 800-volt.
- C₇, C₈—4 μ fd., 800-volt.
- C₉—0.05 μ fd., 200-volt.
- R₁—1.0 megohm, 1-watt.
- R₂, R₄—50,000 ohms, 1/2-watt.
- R₃—0.5 megohm, 1-watt.
- R₅, R₆—0.2-megohm potentiometer.
- R₇, R₈—0.1 megohm, 1/2-watt.
- R₉—0.5 megohm, 1-watt.
- R₁₀—0.5-megohm potentiometer.
- R₁₁—0.25 megohm, 1/2-watt.
- R₁₂—50,000-ohm potentiometer.
- R₁₃—0.5 megohm, 1/2-watt.
- L₁, L₂—5 henrys.

μ fd., and also connected to the synchronizing input terminal. Fig. 6 shows the circuit of a simple double-oscillator which is convenient for obtaining the test signals. A beat-frequency audio oscillator and r.f. signal generator of the service-equipment type may be available; if so, they will furnish convenient signal sources. However, it is desirable to have signals of the order of 15–20 volts, which the r.f. service outfit may not supply without amplification.

The same scanning circuits are used for either

the 906, 902, or the 913 cathode-ray tube. Some simplification of the power supply can be made in the case of the 902 and 913. Fig. 3 shows the power supply and cathode-ray

with this signal. If both high and low frequencies are applied together and the scanning oscillators synchronized, a checkered pattern will appear which will show both vertical and horizontal distribution at once. (It is not necessary to do this; each may be taken separately.) Fig. 5 shows a distribution pattern produced on a 906 tube in this manner.

The test signals are applied to the video input terminal shown on Fig. 2 through a blocking condenser of 0.1

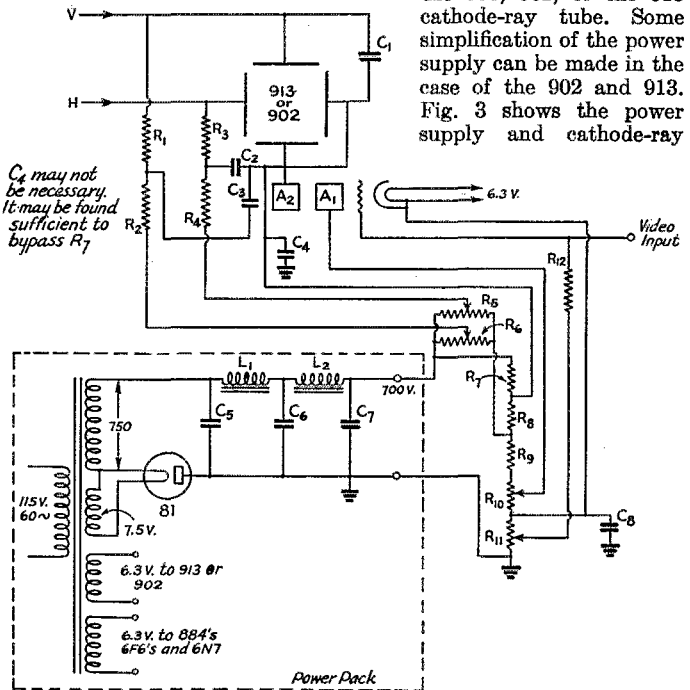

FIG. 4—POWER SUPPLY AND CATHODE-RAY TUBE CONNECTIONS FOR THE 913 AND 902

Everything except the power pack is built into the same unit as the equipment in Fig. 2.

- C₁—0.001- μ fd. mica.
- C₂, C₃—1 μ fd., 200-volt.
- C₄—0.5 μ fd., 800-volt.
- C₅—16 μ fd., 800-volt.
- C₆, C₇—4 μ fd., 800-volt.
- C₈—0.05 μ fd., 200-volt.
- R₁—1.0 megohm, 1-watt.
- R₂, R₄—50,000 ohms, 1/2-watt.
- R₃—0.5 megohm, 1-watt.
- R₅, R₆—0.2-megohm potentiometer.
- R₇, R₈—0.1 megohm, 1/2-watt.
- R₉—0.5 megohm, 1-watt.
- R₁₀, R₁₁—0.2-megohm potentiometer.
- R₁₂—0.5 megohm, 1/2-watt.
- L₁, L₂—5 henrys.

tube connections for the 906, and Fig. 4 shows these for the 902 and 913. A special doubler arrangement is used for the 906 which supplies both high and low voltages from a single transformer winding. An ordinary receiver power transformer

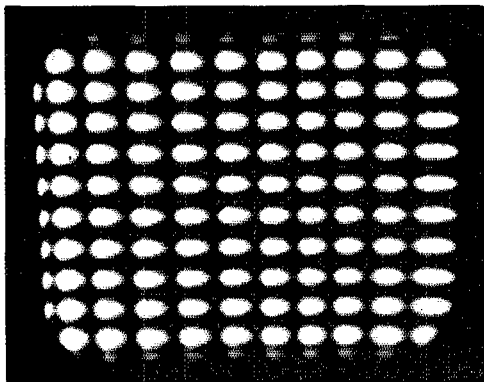

FIG. 5—THE PATTERN PRODUCED ON THE SCREEN OF THE 906 BY THE OUTPUT OF THE BAR PATTERN GENERATOR OF FIG. 6

will take care of all the requirements with the possible exception of the 81 filament, which may call for a separate transformer. The filter condenser requirements can be met economically by using combinations of standard 450-volt electrolytics; for example, four 16- μ f. condensers in series-parallel to give 16- μ f. and two 8- μ f. condensers in series to give 4 μ f.

It will be noted that, contrary to usual oscillograph practice, the cathode-ray tube is operated with cathode near ground potential and second anode at high positive potential with respect to ground. This arrangement permits a d.c. connection to the grid of the cathode-ray tube. The direct connection allows the use of the receiver, with the transmission scheme of d.c. carrier modulation for control of the background intensity of the picture, without the use of a d.c. restoring tube. This of course requires d.c. amplification between the second detector and cathode-ray grid, or a d.c. connection from second detector to cathode-ray grid if sufficient output is available without amplification.

Potentiometers R_5 and R_6 are adjustments which permit the picture to be centered on the screen.

In the absence of scanning, the intensity control should be turned far down to avoid a bright, stationary spot which

may permanently damage the screen. The usual precautions in the handling of high-voltage apparatus should, of course, be observed.

The power supply should preferably be built as a separate unit and connected by cable to the cathode-ray and scanning unit. If the second-anode lead is run separately and isolated, the high-voltage by-pass condenser C_4 may not be necessary, in which case, however, R_7 should be by-passed by a 1- μ f., 200-volt condenser.

It is recommended that panel controls be made of the two amplitude, the two fine-frequency, and the brilliance and focus controls. The remainder of the controls can be screw-driver adjustments; that is, the potentiometer shafts are cut short and slotted with a hacksaw to receive a screw-driver blade.

On page 22 are shown photographs of images transmitted from a Monoscope and received on the 913, 902, and 906, respectively. Despite the inferior resolution of the smaller tubes, the smaller size of the picture tends to mask the loss of detail. The photographs were 30-second exposures, which gives some idea of the stability of the outfit. These pictures were received by direct wire connection of the video signal, no r.f. system being interposed. While the performance of regular Kinescopes must not be expected, it is nevertheless felt that some very acceptable results are obtained.

Strays

General Electric Bulletins GES-1996 and GEA-1999 are asimuthal world projection maps centered on Schenectady, New York, and Oakland, California, respectively. These bulletins, printed on letter-size paper, should be convenient for use on the operating tables of DX men.

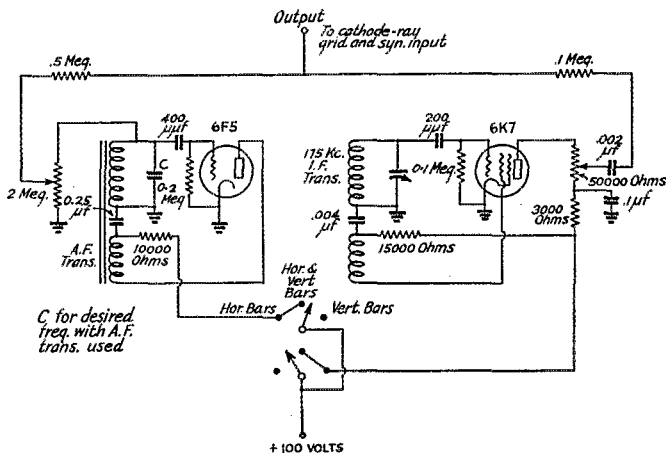

FIG. 6—CIRCUIT OF A SIMPLE BAR PATTERN GENERATOR FOR CHECKING THE LINEARITY OF SWEEP VOLTAGES

What the League Is Doing

League Activities, Washington Notes, Board Actions—For Your Information

Election Notice To all members of the American Radio Relay League residing in the Central, Hudson, New England, Northwestern, Roanoke, Rocky Mountain, Southwestern and West Gulf Divisions.

You are hereby notified that, in accordance with the constitution, an election is about to be held in each of the above-mentioned divisions to elect both a member of the A.R.R.L. Board of Directors and an alternate thereto, for the 1939-1940 term. Your attention is invited to Sec. 1 of Article IV of the constitution, providing for the government of the A.R.R.L. by a Board of Directors; Sec. 2 of Article IV, and By-Law 12, defining their eligibility; By-Laws 13 to 23, providing for the nomination and election of division directors, and By-Law 14 providing for the simultaneous election of alternate division directors. Copy of the Constitution & By-Laws will be mailed any member upon request.

Voting will take place between November 1 and December 20, 1938, on ballots that will be mailed from the headquarters office in the first week of November. The ballots for each election will list, in one column, the names of all eligible candidates nominated for the office of director by A.R.R.L. members residing in that region; and, in another column, all those similarly named for the office of alternate. Each member will indicate his choice for each office.

Nomination is by petition. Nominating petitions are hereby solicited. Ten or more A.R.R.L. members residing in any one of the above-named divisions may join in nominating any eligible member of the League residing in that division as a candidate for director therefrom, or as a candidate for alternate director therefrom. No person may simultaneously be a candidate for the offices of both director and alternate. A separate petition must be filed for the nomination of each candidate, whether for director or for alternate director. The following form for nomination is suggested:

(Place and date)

Executive Committee

*The American Radio Relay League
West Hartford, Conn.*

We, the undersigned members of the A.R.R.L. residing in the Division, hereby nominate of as a candidate for director (or for alternate director, as the case may be) from this division for the 1939-1940 term.

(Signatures and addresses)

The signers must be League members in good standing. The nominee must have been both a member of the League and a licensed radio amateur operator for a continuous term of at least four years immediately preceding the receipt by the Secretary of his petition of nomination. He must be without commercial radio connections: he may not be commercially engaged in the manufacture, selling or renting of radio apparatus normally capable of being used in radio communication or experimentation, nor commercially engaged in the publication of radio literature intended, in whole or in part, for consumption by licensed radio amateurs. Further details concerning eligibility are given in By-Law 12. His complete name and address should be stated. All such petitions must be filed at the headquarters office of the League in West Hartford, Conn., by noon E.S.T. of the 20th day of October, 1938. There is no limit to the number of petitions that may be filed, but no member shall append his signature to more than one petition for the office of director and one petition for the office of alternate director. To be valid, a petition must have the signatures of at least ten members in good standing; that is to say, ten or more members must join in executing a single document; a candidate is not nominated by one petition bearing six signatures and another bearing four signatures. Petitioners are urged to have an ample number of signatures, since nominators are frequently found not to be members in good standing.

Present directors and alternates for these regions are as follows: Central Division: director, R. H. G. Mathews, W9ZN, Chicago; alternate, Adam F. Moranty, W8CZT, Cleveland. Hudson Division: director, Kenneth T. Hill, W2AHC, Douglaston, L. I.; alternate, Robt. M. Morris, W2LV, Millburn, N. J. New England Division: director, Percy C. Noble, W1BVR, Westfield, Mass.; alternate, Frederick A. Ells, Jr., W1CTI, Norwalk, Conn. Northwestern Division: director, Ralph J. Gibbons, W7KV, Pendleton, Ore.; alternate, A. L. Smith, W7CCR, Missoula, Mont. Roanoke Division: director, Hugh L. Caveness, W4DW, Raleigh, N. C.; alternate, J. Frank Key, W3ZA, Buena Vista, Va. Rocky Mountain Division: director, Edward C. Stockman, W9ESA, Denver; alternate, Eddie L. Heyer, W9GBQ, Sedalia, Colo. Southwestern Division: director, Charles E. Blalack, W6GG, El Centro, Calif.; alternate, John E. Bickel, W6BKY, Whittier, Calif. West Gulf Division: director, Wayland M. Groves, W5NW, Mt. Pleasant, Texas; alter-

nate, Wm. B. Hollis, W5FDR, Houston, Texas.

These elections constitute an important part of the machinery of self-government in A.R.R.L. They provide the constitutional opportunity for members to put the direction of their association in the hands of representatives of their own choice. Members are urged to take the initiative and file nominating petitions immediately.

For the Board of Directors:

K. B. WARNER,
Secretary

August 1, 1938.

Delays The F.C.C.'s ultra-high-frequency allocation from 60 to 300 Mc., which was to have become effective October 13th, has been postponed to April 13th next, to provide time for the Commission to redetermine its u.h.f. policy following the recent hearing of commercial complaints that too many frequencies have been assigned to government and television uses. The chief point made by the protestants is that not enough is known of the u.h.f. art to warrant allocation up to 300 Mc. and that it should stop at 150 Mc. If this point of view prevails, we shall get our new band at 112-118 Mc. as an exclusive assignment, but the higher bands would not be earmarked for any particular service until the art makes further progress. However, we would continue to possess joint experimental rights to all of the higher frequencies, just as we enjoy them to-day on all frequencies above 110 Mc. Presumably the Commission intends to wait until next April before releasing any of the definite assignments above 60 Mc. On the other hand, there have been no complaints about the projected amateur u.h.f. bands and it seems to us that the Commission might well allocate these bands to us while revising our regulations.

Official Washington has been very much in the doldrums during the dog-days of late summer. At the time of writing, no action has been taken on the contemplated general revision of our regs, although it is still hoped to make them effective in the early autumn.

Financial Statement Operations for the second quarter of this year resulted in a loss to the League of nearly \$8,500. While it is customary for operations to yield a loss during the second and third quarters of the year, this quarter's deficit is the largest on record. Largely this was a result of the very bad business conditions that existed generally during this period but partly it was because League activities are now at a larger scale than ever before and expenses of course continue during lean quarters as well as good. With business conditions improving, the League expects to finish the year in the black. (The first quarter yielded a gain of over \$16,000.)

At the instructions of the Board of Directors, the operating statement for the second quarter is presented for your information.

STATEMENT OF REVENUES AND EXPENSES, EXCLUSIVE OF EXPENDITURES CHARGED TO APPROPRIATIONS, FOR THE THREE MONTHS ENDED JUNE 30, 1938

REVENUES			
Membership dues	\$ 9,528.10		
Advertising sales, QST	21,611.49		
Newsdealer sales, QST	10,638.38		
Handbook sales	5,196.64		
Spanish edition Handbook revenues	118.90		
Booklet sales	2,040.83		
Calculator sales	265.52		
Membership supplies sales	1,890.38		
Interest earned	395.68		
Cash discounts received	232.75		
Bad debts recovered	8.07	\$51,926.74	
Deduct:			
Returns and allowances	\$ 3,507.82		
Exchange & collection charges	10.25		
Cash discounts allowed	380.20		
	\$ 3,898.27		
Less decrease in reserve for newsdealer returns of QST	196.06	3,702.21	
Net revenues			\$48,224.53
EXPENSES			
Publication expenses, QST	\$16,437.42		
Publication expenses, Handbook	3,262.48		
Publication expenses, booklets	708.09		
Publication expenses, calculators	93.68		
Spanish edition Handbook expenses	559.18		
Salaries	24,091.76		
Membership supplies expenses	1,049.21		
Postage	1,743.71		
Office supplies and printing	1,307.47		
Travel expenses, business	1,432.90		
Travel expenses, contact	639.11		
QST forwarding expenses	1,014.53		
Telephone and telegraph	592.19		
General expenses	1,476.91		
Insurance	36.53		
Rent, light and heat	1,142.10		
General Counsel expenses	294.89		
Provision for depreciation of furniture and equipment	328.72		
Communications Department field expenses	127.15		
Headquarters station expenses	138.28		
Alterations and repairs expenses	6.10		
Bad debts written off	131.15		
Total expenses		56,723.56	
Net loss before expenditures against appropriations			\$ 8,499.03



Judging by questions asked at a number of conventions where the four-band 814 transmitter was demonstrated by Reinartz, the close coupling intentionally used between plate coil of an oscillator and plate coil of the following stage has led to much confusion. Actually, this coupling prevents oscillation, for the circuit when operated with output at crystal frequency is simply an inductively neutralized amplifier.

A Six-Band One-Kilowatt Transmitter

Compact Four-Stage Outfit for C.W. or 'Phone

By J. E. Jennings,* W6EI

Besides describing a particular transmitter, the author also discusses some aspects of circuit operation not so generally appreciated. Even if you're not interested in having a kilowatt there are some good pointers to be picked up from reading this article.—EDITOR

DURING the past few years a great variety of combinations of tubes and circuits have been employed in high-power transmitters, but unfortunately the flexibility of the transmitter often goes down in some ratio to the increase in power and efficiency. Being an average ham, my interest is not confined to any one band, and the ability to change frequency rapidly not only inside a given band but also from band to band was a prime consideration. An ideal transmitter for amateur work should operate on all bands from 56 to 1.75 Mc., should be capable of the maximum input allowed by law, and should be usable on both 'phone and c.w. To put on the air a clean signal free from excessive harmonic radiation and "splatter," when fully modulated, tank circuits designed for optimum values of Q should be provided. The band-changing should be a simple operation not necessitating a major overhaul, so that when things are "hot" on any band rapid change-over can be accomplished.

With the above requirements in mind the writer attempted to build such a transmitter by

* S. 24th St., San Jose, Calif.

utilizing some of the newer ideas in radio transmission as well as some of the newer equipment. We feel that the transmitter to be described has met practically all of the requirements. Since the speech equipment is no concern of the present article its description will be omitted.

A pair of 100TH tubes was chosen for the final amplifier since two of these tubes will handle a full kilowatt readily. With 3000 volts and a plate current of 330 milliamperes, plate efficiencies over 80 per cent can be obtained. This means that a carrier power of the order of 750 watts should be expected.

If the tank circuits are properly designed very little harmonic radiation should take place, with the result that practically all of the output is confined to the fundamental frequency. The tank circuit presents a problem which could not be solved until the advent of the vacuum tank condenser, inasmuch as no conventional tank condenser having adequate spacing for 3000 volts on the plate with 100 per cent plate modulation was available in the necessary capacity for optimum tank circuit Q on the lower frequencies. The final tank circuit uses a 6- μ fd. vacuum condenser for 28-Mc. operation, a 12- μ fd. condenser for 14-Mc., a 12- μ fd. condenser for 7-Mc. (c.w. only), a pair of 50- μ fd. condensers for 1.75-Mc., and a 50- μ fd. condenser for 3.5-Mc. A more economical arrangement, though not quite as convenient, is to use a 6- μ fd. condenser for 28 Mc., parallel another 6 μ fd. for 14- and 7-megacycle operation, a single 50- μ fd. unit for 3.5 Mc. with a second 50- μ fd. section connected in parallel for 1.75 Mc. Thus it is possible to cover all the bands with only four units.

Tuning of the tank circuit can be accomplished in a number of ways, but since the value of capacity is fixed for opti-

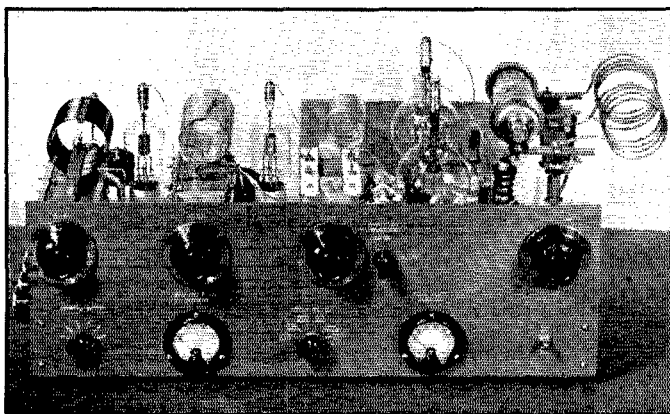

A FOUR-STAGE ALL-BAND KILOWATT TRANSMITTER

Featuring a switching system which cuts out unneeded stages on low-frequency bands, plus plug-in fixed tank condensers for good L-C ratios. The mechanism for varying the final tank inductance can be seen just to the right of the coil mounting.

imum Q , the inductance preferably should be the variable factor. The tank circuits are made up as units with the proper coil and capacity already combined. A refinement of the plug-in arrangement would be to build a unit holding all of the tank circuits and to select the tank circuit for the desired frequency by means of a switch in the plate lead to each tube. Voltage insulation of this switch would of necessity be high but since the capacity and inductance are in a unit very little circulating current would flow through the switch, hence the contacts could be small. This elaboration was not used since there was no objection to changing only the final tank; the rest of the transmitter requires no coil changing.

EXCITER STAGES

Operation of the 100TH's with a kilowatt input as a Class-C modulated amplifier requires from 50 to 75 watts of grid excitation power. The conventional exciter uses receiving type tubes for the oscillator and frequency multiplier stages, thus necessitating one or two buffer stages to obtain the desired power output. Such an arrangement usually requires the changing of many coils and always has the disadvantage of having more than one stage operating at the same frequency at the same time. The 35T makes a good crystal oscillator tube and outputs of 50 to 75 watts are obtained on the 3.5- and 1.75-Mc. bands. This output is quite sufficient fully to excite the final amplifier on 3.5 or 1.75 Mc. No reaction on the crystal oscillator stage is detectable, so that the use of a buffer stage is unnecessary. The plate tank condenser of the oscillator is 200 $\mu\text{fd.}$, this value being chosen so that the tank circuit could be tuned from the low-frequency end of the 1.75-Mc. band to the high-frequency end of 3.5 Mc. without changing coils. Suitable crystals are switched into the grid circuit when operation on either of the bands is desired; of course the tank circuit must be adjusted for resonance with the proper crystal. The coil is "pruned" so that the 1.75-Mc. limit is reached with the condenser at maximum capacity and 4 Mc. with the condenser at minimum capacity.

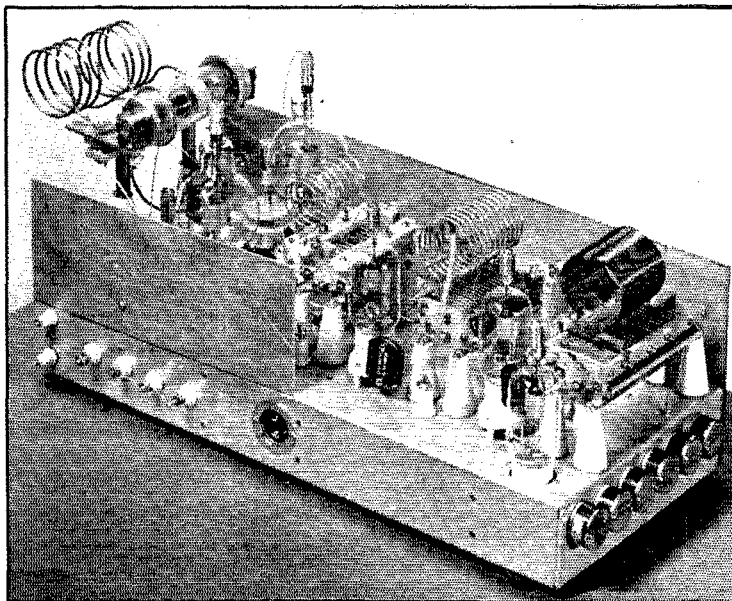

THE REAR VIEW SHOWS MOST OF THE ABOVE-CHASSIS LAYOUT
Note the crystals plugging in along the rear chassis edge. The crystal switching, which is conventional, is not shown in the diagram.

The plate voltage used on the crystal oscillator may be anything from 1000 to 1500 volts. Such high voltages are rather unusual for a crystal oscillator stage but present no hazard to the crystal providing a few precautions are taken. The low interelectrode capacity of the 35T prevents excessive feed-back, and if some method is used to limit the grid swing, crystal currents well within the crystal manufacturer's rating can be realized. (Of course the crystal should be well isolated from the plate circuit.) The easiest method of limiting the grid swing is to eliminate the conventional grid leak entirely, bias being obtained from a 500-ohm cathode resistor. This value has been found to give the best all around results. It is very important that this resistor be non-inductive, since dangerously high crystal currents may result if an inductive resistor is used. As a precaution it is wise to keep a 60-ma. pilot bulb in series with the crystal. Ordinary flashlight bulbs are worthless as a protective device because many of them require more than 300 ma. to blow. The 60-ma. variety burn out at about 120 ma. To prevent modulation of the output of the crystal it is necessary to return the bias lead either to a center tap on the filament transformer or to a center-tapped resistor.

FREQUENCY MULTIPLIERS

The first frequency multiplying stage is also a 35T and is designed to operate either as a doubler or a quadrupler. Again the tank capacity is great enough to allow a frequency range of slightly

more than two to one. With a properly pruned coil this stage covers from the low-frequency end of 7 Mc. (doubling) to the high-frequency end of 14 Mc. (quadrupling). No difficulty should be experienced in obtaining 50 to 75 watts output from this stage on either band with excitation from the 3.5-Mc. oscillator. Thus we have adequate excitation for the final without changing anything but the setting of the frequency-multiplier tank condenser. The third harmonic is very strong, by the way, and should not be confused with the fourth.

A few points about the successful operation of such a stage might be in order. The power gain of the stage goes down as the order of the harmonic goes up. For example, a power gain of 4 to 6 might be expected on the second harmonic while on the fourth harmonic practically no power gain can be realized. This means that for 50 to 75 watts output on the fourth harmonic practically that much grid drive must be supplied by the oscillator. The bias for this stage is obtained

from a 50,000-ohm grid leak. With the normal grid current of about 20 ma. a bias voltage in the order of 1000 volts is obtained—almost equal to the plate voltage! It will be noted from the diagram that this stage is "neutralized"; actually, a slightly greater capacity than is necessary for neutralization is used. This additional capacity greatly accentuates the fourth harmonic without causing instability.

The second frequency multiplying stage is used for 56- and 28-Mc. operation, quadrupling or doubling respectively. It was hoped that a coil-condenser combination could be found that would cover both 56 and 28 with the same coil, but because of high stray capacities this arrangement proved impracticable. The only coil change necessary in the exciter unit is for five-meter operation.

INTERSTAGE COUPLING

The exciter unit employs capacitive coupling throughout in order to reduce the number of

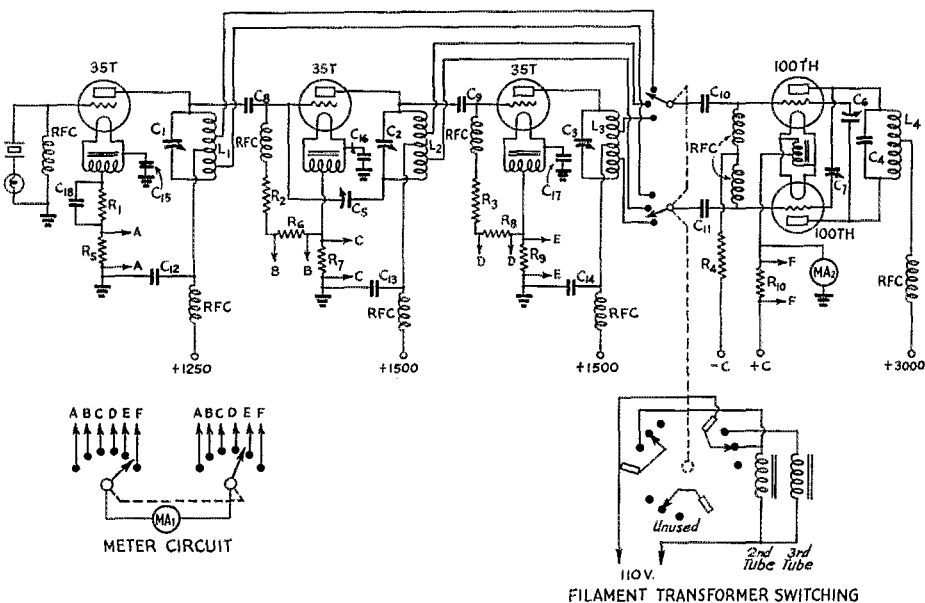

FIG. 1—CIRCUIT DIAGRAM OF THE SIX-BAND HIGH-POWER TRANSMITTER

- C₁—200- μ fd. variable, 0.07" spacing (Cardwell MT-100-GD with sections connected in parallel).
- C₂—150- μ fd. variable, 0.07" spacing (Cardwell MT-150-GS).
- C₃—35- μ fd. variable, 0.084" spacing (Cardwell NP-35-ND).
- C₄—Fixed vacuum condensers; 28 Mc.: 6 μ fd.; 14 Mc. and 7 Mc.: 12 μ fd.; 3.5 Mc., 50 μ fd.; 1.75 Mc., 100 μ fd. (Eimac type VC).
- C₅, C₆, C₇—2-10 μ fd. disc-type neutralizing condenser (National NC-800).
- C₈ to C₁₄, inc.—0.002- μ fd. mica, 5000-volt.

- C₁₅ to C₁₈, inc.—0.002- μ fd. mica, 1000-volt.
- R₁—500 ohms, 25-watt.
- R₂, R₃—50,000 ohms, 50-watt.
- R₄—2000 ohms, 75-watt.
- R₅ to R₁₀, inc.—50 ohms, 10-watt (for metering).
- RFC—Sectional-wound r.f. chokes of current ratings suitable for stage (see text).
- L₁—30 turns No. 20, length 1 1/4 inches, inside diameter 2 1/2 inches, center-tapped; excitation taps 7 turns each side center.
- L₂—11 turns No. 14, length 3/4 inches, inside diameter 2 inches, center-tapped; ex-

- citation taps 2 3/4 turns each side center.
- L₃—8 turns No. 14, length 3 inches, inside diameter 1 3/4 inches, center-tapped; excitation taps 2 1/4 turns each side center (for 28 Mc.). 56-Mc. coil four turns, adjusted to resonate over band with C₄.
- L₄—Barker & Williamson HDVL coils, adjusted and tuned as described in the text.
- Sw—Three-pole, three-position, three-section Isolantite-insulated switch (Centralab).
- Ma₁—0-250 d.c. milliammeter.
- Ma₂—0-500 d.c. milliammeter.

controls to a minimum and also to take full advantage of the high μ of the tubes used. As the frequency multiplying stages operate with very high bias a large voltage swing from the driver stage is required. To obtain this large swing the grid of the following stage is connected directly to the "hot" end of the driver plate coil through a suitable blocking condenser. If the frequency-multiplying stage is not required that circuit is made ineffective merely by turning out the filament of the unwanted tube.

The grids of the 100TH's are switched to the proper driver stage by means of two sections of a small Isolantite-insulated switch of the type used in receivers. A third section of this combination switch automatically provides the proper sequence to the lighting of the tube filaments. Individual filament transformers facilitate metering of the various circuits and also provide a method of controlling the filament power by opening the primary circuits.

Even though the grid leak is 50,000 ohms, very heavy loading of the driver stage will result if this grid leak is connected directly in the circuit without the use of series radio-frequency chokes. The best chokes are none too good, and for best results several of the conventional type may have to be connected in series. If still greater efficiencies are desired it will be necessary for you to "roll your own."

TUNING THE FINAL AMPLIFIER COIL

Several methods of tuning the final amplifier were tried. It seems that any scheme will work well providing the proper mechanical details are worked out. Probably the simplest method is to shunt a comparatively small variable condenser across a few turns of the inductance, allowing the vacuum condenser to shunt the whole coil. The tuning range of the condenser goes down as the voltage across it is made smaller. To make a very small condenser withstand the high voltages existing across the coil during 100 per cent modulation the tuning range becomes very limited. Probably a compromise between tuning range and physical size will give the proper conditions of operation, although it must be pointed out that an advantage of the vacuum condenser is its small physical size, and a bulky tuning condenser will add stray capacity to the circuit with the result that full tank-circuit efficiency may not be realized.

Methods of varying the inductance were tried with excellent results. A single closed turn of quarter-inch copper tubing tunes the circuit quite

well, although probably the best method found to date is to use several turns of wire in series with the main inductance. The final coils were built from Barker & Williamson HDVL coils with a few turns of the same size wire as the main coil connected in series. Mechanical adjustment of the variable coil is made by means of a flexible shaft that connects to the center post of the coil assembly by means of a spline. The number of turns necessary to cover any one band varies from $5\frac{1}{2}$ turns at 3.5 Mc. to $\frac{1}{2}$ turn on 28 Mc.

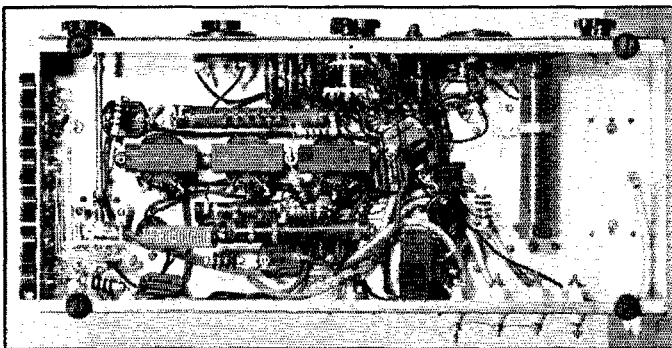

BESIDES THE USUAL BY-PASS CONDENSERS AND RESISTORS, THE BOTTOM OF THE CHASSIS ALSO CONTAINS THE CRYSTAL AND METER SWITCHES, AND SEPARATE FILAMENT TRANSFORMERS FOR EACH STAGE

The variable coil should be made to rotate through 360 degrees so that the extra inductance either adds to or subtracts from the main inductance of the coil.

The picture of the transmitter shows still another method of varying the inductance which works quite well. The tank coil is split in the center and one-half of the coil is moved up and down by means of a threaded shaft. The inductance is varied as the mutual coupling between the coil sections is varied. Any of the above methods gives excellent results and there is little choice between them from the standpoint of electrical efficiency. The minimum plate current of the final amplifier should be between 20 and 35 mils at unloaded resonance with a plate voltage of 3000.

ADJUSTMENT

A transmitter of this type is, in its completed form, a very simple and practical unit. However the final results were obtained only after considerable "bug" hunting. We trust that a few suggestions will save needless duplication of some of the more obvious difficulties.

The coil sizes and condenser capacities were chosen after a lot of experimental work. If variable condensers of other makes than those shown are used, be sure the minimum capacities are at least as low as the ones used here, since probably the biggest difficulty in obtaining a two-to-one

(Continued on page 88)

Characteristics of Sky-Wave Transmission

A Discussion of Some High-Frequency Transmission Effects of Practical Interest to the Amateur

By Harner Selvidge,* W9BOE

SAY, Joe, the band sure has been acting funny here to-day. I don't know what the trouble is," wails our friend Archie into his chromium-plated kilowatt. Sure enough, the band is acting up, and in the middle of his next sentence Archie goes into a walloping fade which twists his voice into a mush that the worst non-linear Class-B stage couldn't equal, and we mercifully shut off the receiver and wonder why Archie didn't know what the trouble was with the band. If he had only known how to do it, he could have discovered what was wrong in a few minutes by listening on his receiver — and he wouldn't have to do any slide-rule work, or wait until Wednesday and copy WWV's ionosphere reports, either. But Archie didn't know what to listen for, and who can blame him? What ham wants to wade through pages of high-powered theory on ordinary and extraordinary rays, magneto-ionic splitting, elliptical polarization, refractive indices, and all the other polysyllabic emissions from the realm of atmospheric physics, in the hope of finding out what the trouble is when the band starts acting up. Suppose he *does* know what "conditions" are, he can't change the Kennelly-Heaviside layer, can he? No, he can't, but he might save himself a lot of mental distress, as well as wear and tear on his tonsils, if he did know what was going on. It is the object of this article to remove the theoretical and mathematical whiskers from some of these things that Archie would like to know about, and set forth a few items which have a direct practical application to amateur transmission. There is only one worry: Archie, we are afraid, won't read the article. It won't be because it is too tough for him, but it will be because of the fact that, really to know what

* Kansas State College, Manhattan, Kansas.

happens to signals after they leave an antenna, one must thoroughly understand things like skip-distance. "Shucks," says Archie, "I know all about skip-distance." Maybe so, Archie, but your remark to Joe doesn't show that you do. If you will just stay with us through a little elementary stuff, you may find out the answers to some of those things you have often wondered about.

Engineers and physicists have been very much interested in what happens to radio signals in the upper atmosphere since 1901, when Marconi first demonstrated that signals could be transmitted across the Atlantic Ocean. It is of interest to note that prior to this time scientists had claimed such a thing was impossible. The correct explanation of why this transmission was possible was given the following year by Kennelly, and also Heaviside, in articles suggesting the probability of a reflecting layer in the upper atmosphere which kept the signals from leaving the earth and being lost in space. However, it was not until amateurs explored the regions below 200 meters and skip-distance was discovered, that much interest was taken in the Kennelly-Heaviside Layer. This was the result of experiments by John Reinartz¹ and other amateurs in 1924, and nearly all our present knowledge of transmission effects, particularly in the short-wave region, dates from that time. We know now that there are several of these reflecting layers in the upper atmosphere, and if one knows a few simple facts about what happens when a radio wave strikes one of them he will find that he also has a good understanding of the various peculiarities of the amateur bands.

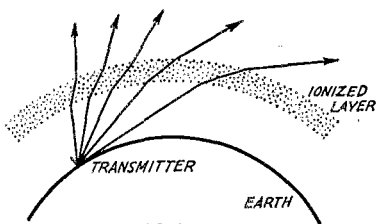

FIG. 1A

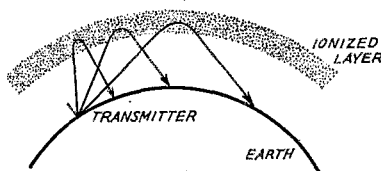

FIG. 1B

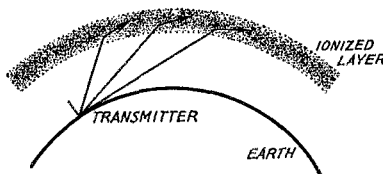

FIG. 1c

THE REFLECTING LAYER

We need only a very brief explanation of the composition of these reflecting layers,

¹ Reinartz, "The Reflection of Short Waves," *QST*, April, 1925.

and how they reflect radio waves. They are formed when energy radiated from the sun, in the form of ultra-violet light, strikes the gases in the upper atmosphere. This radiant energy knocks some of the gas molecules apart, into negative and positive charges of electricity. This process is called ionization, and the ionized region is generally called the ionosphere. Radio waves will travel faster when they strike such a region, and this change in speed causes them to bend in their path, and may even cause them to become completely reflected by the layer and thus be returned to the earth. It is also possible to get so much ionization that the waves may be absorbed at low levels and not be reflected, but this effect is less important at high frequencies than at lower frequencies. Therefore we have three possibilities, as shown in Fig. 1. (For the purpose of simplification only one reflecting layer is shown.) There may be so little ionization that the signals will be bent only slightly, and will pass on through the layer and not be returned to the earth as in Fig. 1A. The next case is Fig. 1B, which shows enough ionization to bend and reflect the waves back to earth, while in Fig. 1C we find so much ionization that the waves are absorbed.

When we consider the effect that the wavelength of the transmitter signal has on the amount of reflection from the ionized layers, it is helpful to remember that light and radio signals are the same kind of waves, the only difference being one of wavelength. We know we see the sun, moon, and stars through these layers, so we come to the conclusion that very short waves will go through and not be reflected. This is the actual case, as shown in Fig. 2. Here the same amount of ionization is present in the layer during the transmission of 14- and 30-megacycle signals. The 14-Mc. signal (solid lines) is reflected and returns to the earth, while the 30-Mc. signal (dotted lines) is bent only slightly by the layer and is lost in space. At the same time we should find that signals in the low-frequency bands below 14 Mc. also would be reflected, and those above 30 Mc. would pass on through and be lost. We have now two important facts to remember. First, the lower the transmitted frequency, the greater the likelihood of reflection. Second, the stronger the ionization in the reflecting layer (neglecting absorption) the higher the frequencies which it will reflect.

SKIP DISTANCE

We must also take into account the effect of the angle at which the signals strike the layers. For example, suppose you stand on the bank of the river and shoot a rifle directly down at the water. The bullet will penetrate the surface and go on down. But if you shot at something out in midstream, where the bullet would strike the water at a low angle, you would probably find that it would bounce right off the surface and

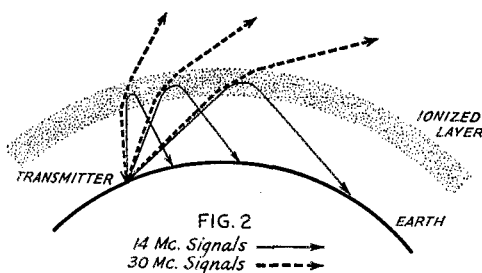

continue on. The same thing may occur when a radio signal strikes an ionized layer in the upper atmosphere, and this is what gives rise to the effect known as skip distance. It takes place when the ionization is not sufficient to reflect signals of a particular frequency when they strike the layer at a steep angle, but will reflect them when they strike the layer at a smaller angle. This is illustrated in Fig. 3, which shows all waves radiated from the antenna at greater than a certain critical angle will penetrate the layer and be lost, while all low-angle radiation will be returned to earth. In the skip-distance region no signals will be heard, providing you are beyond the range of the ground wave near the transmitter. It will also be observed that the ray shown striking the earth at the limit of the skip-distance zone at A is shown being reflected from the surface of the earth, striking the layer again, and once more being reflected and returning to the earth at B. Two-, three- or four-hop transmission paths of this kind are very common in high-frequency transmission, particularly over long distances. In Fig. 3 we see that we may also have a signal arriving at B after only one reflection. If these two signals arriving at B are about the same strength we may find bad fading as they interfere with each other. Recalling the statement at the close of the preceding paragraph, that the lower the frequency the better it is reflected by the layer, we can see that the amount of ionization shown in Fig. 3, which would reflect only low-angle radiation on 14 Mc. probably would reflect 7-Mc. signals striking it from all angles, thus making zero skip-distance on that and all lower frequency bands.

SKIP DISTANCE AND TRANSMISSION CONDITIONS

We can make use of this skip-distance effect to tell us what is going on in other bands merely by listening on one. Suppose we hear stations as close as 100 miles on 14 Mc. We conclude at once that there is a good deal of ionization overhead, and that 30-Mc. signals are also being returned to earth. On the higher frequency the skip-distance will be perhaps 1000 miles, but that is short enough to make the 30-Mc. band very active. Since we have observed a very short skip on 14 Mc. we can tell that 7 Mc. will have zero skip, as will the 3.5- and 1.75-Mc. bands.

Now when we have a long skip-distance we will hear and work only distant stations, but when the ionization increases and skip shortens, we will begin to hear nearby stations. We will then start losing the DX signals for two reasons. First, they are buried under the QRM from nearer stations, and second, the high ionization has started to absorb these distant signals which travel a long way in the ionized regions, so they are usually much weaker. This accounts for the fact that the longer the skip-distance and the higher the frequency band you can work, the better your chance for DX.

Since radiation from the sun causes the ionization in the upper atmosphere, we would expect to

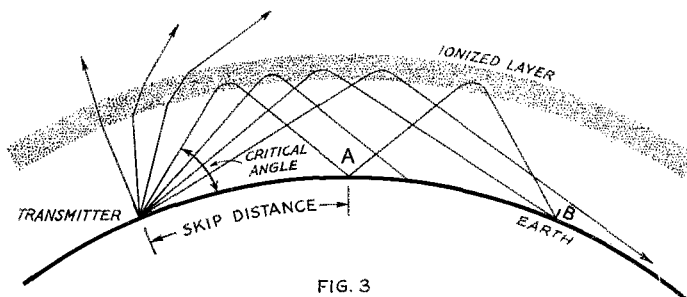

FIG. 3

find different conditions during the night and the day. For example, let's see what takes place during a normal winter day. In the early morning hours before sunrise there is little ionization present, since no energy is being received from the sun. Under these conditions we find 30 Mc. gone completely, and only a few very distant signals (or none at all) on 14 Mc. There is enough remaining ionization from the day before to reflect the lower frequency signals somewhat, and we find DX conditions on 7 Mc. and a short skip on 3.5 Mc., with probably zero skip on 1.75 Mc. As the sun rises, the ionization will increase rapidly and reach a maximum at about noon. Thus as noon approaches, the skip will get shorter on all bands, in mid-morning becoming short enough to return 30-Mc. signals to earth. We find the 14-Mc. cycle band full of comparatively local signals with nearly zero skip-distance from about 9 A.M. to 3 P.M., during which time the 30-Mc. band is open for DX.² As the sun sets, the ionization decreases, since the free positive and negative charges in the layers will start to recombine as soon as the ionizing agent (light from the sun) is removed. The time which must elapse after sundown before this process is complete will depend on the season and the amount of ionization which was present at the maximum during the day. At any rate, we will find that as evening comes on the skip-distance will increase in each band until

² It should be emphasized that these are more or less idealized conditions and that individual days can deviate considerably from these figures.

first 30-Mc. and then 14-Mc. signals will fade out and not be returned to earth at all.

MAGNETIC STORMS

Now what about that day when our pal Archie found that the band "sure was acting funny"? What he probably noticed was that he didn't hear as many stations as usual, and those he heard were doing a lot of unusual fading. All the old standbys on the band were missing and a lot of new stations were coming in, mostly from a considerable distance. As soon as he noticed this, Archie should have said to himself, "Aha, a magnetic storm." A magnetic storm is the name given to periods when the magnetic field of the earth (usually fairly steady) undergoes violent fluctuations in strength. Scientists do not know whether the storms themselves cause changes in the ionosphere, but they do know that whenever there is a magnetic storm it is accompanied by a reduction in ionization in the upper atmosphere. Now we can see what happened to the signals which failed to appear during that period—

the skip distance increased so much, on account of the low ionization, that they were no longer reflected. We find, then, that we have *night* conditions during the *day*, and conditions of this kind will last throughout the duration of the storm, which may be anywhere from one to three days. During this time we will find that the high-frequency bands usually will fade out much earlier in the evening than on normal days. During the storm we will usually find good DX on 14 Mc. at noon, when on normal days we would only be able to work about 1000 miles at that hour. Thirty megacycles probably would be completely useless at that time. If one is reasonably familiar with what he normally hears on a band at a particular time of day, he should be able to tell by a couple of minutes' listening if a magnetic storm is in progress. The turbulence in the ionosphere at such times gives rise to considerable fading, accompanied by severe distortion, and this is another important clue. At such times DX hounds will find things just to their liking with plenty of distant signals coming in (if they look on the right bands), but all other hams either will have to QRT or move down to a lower-frequency band until things settle down again.

MULTIPLE LAYERS AND ABNORMAL IONIZATION

Before we talk about seasonal changes, and why 30 Mc. is—or isn't—any good in the summer, there are two other abnormalities that should be mentioned. The first and most important of these is the so-called "abnormal" or "sporadic"

E layer. Most amateurs are familiar with the fact that the ionization in the upper atmosphere occurs in the form of distinct layers above the earth. Why there should be layers rather than a continuous distribution is a point which scientists have been unable to explain. Roughly speaking, the layers usually remain at about the same heights from day to day, and for amateur and high-frequency work, the most important ones are those known as the *E* layer and the *F* layers.³ The *E* layer lies in a region about 100 kilometers (62 miles) above the earth, while the *F* layer region is up approximately 240 kilometers (150 miles). These heights should be carefully noted. They are far above and entirely untouched by any weather conditions on the surface of the earth. We often hear hams commenting on how the weather is affecting "conditions." With the exception of the bending of ultra-high frequencies mentioned in the last part of this article, such effects will almost always be found to be traceable to moisture on feeders and insulators, rather than any change in transmission conditions.

In the *F* region we often find two layers which are known as *F*₁ and *F*₂, the former usually being somewhat below the latter. The higher *F*₂ layer is more heavily ionized than either the *E* or *F*₁ layers, and as a result it is the most important layer in high-frequency transmission, since signals of high-enough frequency to penetrate the moderately-ionized *E* and *F*₁ layers may still be returned to earth by the higher and more-heavily ionized *F*₂ layer. This is shown in Fig. 4. Of course, for lower frequencies the *E* layer is more important, and most of the transmission in the 1.75-Mc. band is by reflection from the *E* layer. It is in this *E*-layer region that we occasionally find a patch or cloud of very intense ionization that is known as the abnormal *E* layer. It may happen at any time, day or night, and the reason for its existence is not known. When it occurs, it may cause signals to be reflected on frequencies as high as 60 megacycles. In fact, its effect is noticed mostly on the 30- and 60-Mc. bands since it often occurs when there is no reflection from the *F* region and these bands would otherwise be dead, so far as sky-wave transmission is concerned. This will be mentioned in more detail in discussing ultra-high frequency transmission.

³ Letters are used merely as a convenient way of identifying the layers. The first two layers found were labeled *E* and *F*, leaving alphabetical space for any possible layers above or below them. This was a wise precaution as we now have evidence of *C*, *D*, and *G* layers also. The letters are arranged in alphabetical sequence ascending from the surface of the earth.

The other abnormality is the so-called "Delinger fade-out."⁴ It may last a few minutes or a few hours, and usually results in an almost complete wiping-out of high-frequency communication on the lighted portion of the globe. The

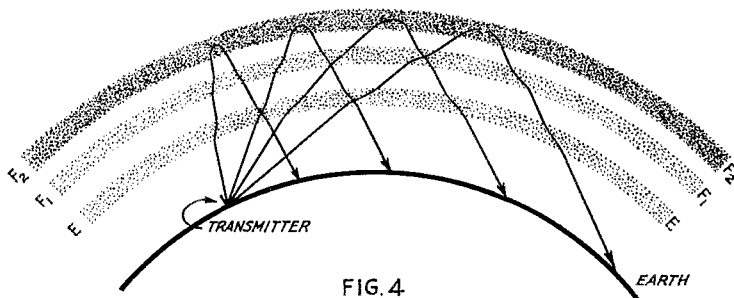

FIG. 4

reason for the disappearance of the signals is just the opposite from that a magnetic storm, the fade-out arising from a very great *increase* in ionization at low levels where it results in absorption of the signals. The magnetic storm always affects higher frequencies first, while the fade-out may affect lower frequencies only, the higher ones being able to penetrate the absorbing layer and be reflected as usual from the *F* region. However, many of these fade-outs are so intense that *all* high frequencies are absorbed, and there is also a considerable decrease in static and atmospheric noise. So if you turn on your receiver some day and it seems nearly dead, don't tear it apart until you are sure that a fade-out isn't to blame.

SEASONAL CHANGES

What happens to the 30-Mc. band in the summer? That brings up the matter of seasonal changes in the ionosphere. We know that the sun is in a different place in the summer time, and since the ionization is caused by the sun we might expect pronounced seasonal changes. The exact reasons why some of these changes take place are not known, but enough data have been collected so that we have at least a fair idea of what to expect. It has been found that the ionization in the *F*₂ layer (which is the one in which we are most interested) is greatest in the winter time, when it reaches its daily maximum at about noon. This means that in a given year the shortest skip-distances will be found at about noon in a winter day. That will be the time that the highest frequencies can be used reliably; for example that will be when the 30-Mc. band will be at its best. In the summer time the maximum amount of ionization is considerably *less* than in the winter, and the daily peak for the *F*₂ layer shifts to about sunset. This means that, on the average, 30 Mc. will have a much longer skip in summer than in winter, and in fact may be out completely a good

(Continued on page 98)

⁴ *QST*, Jan., 1936; June, 1936; Feb., 1937.

Refinements in Combination Exciters

Effective Designs for Low-Power R.F. and Audio Stages

By T. M. Ferrill, Jr.,* W1LJ1

FEW are the amateurs who have not wished for a transmitter¹ which could be operated as easily as the modern receiver. The desire to operate on more than one of the amateur bands, shifting from one to another with great ease and rapidity, has brought development of receivers to the point where it is only necessary either to plug in one unit or turn one knob to select another amateur band, and then simply to turn one dial to select the frequency of reception in that band.

The transmitter or exciter pictured in these pages is as compact as a modern superheterodyne receiver, is designed for operation in a small cabinet or rack on the operating table, is equipped for electron-coupled oscillator as well as crystal frequency control, and is capable of being used on five bands with the utmost convenience. To select any of these bands (160, 80, 40, 20, and 10 meters) it is only necessary to turn one switch knob to the proper position. To select any desired frequency in that band, it is only necessary (with the crystal selector-e.c. switch set for e.c. operation) to turn the calibrated vernier band-spread dial in the center of the panel to the proper setting. If crystal control is preferred, the same procedure is followed with the crystal selector-e.c. switch set for the desired crystal.

If a power output of 20 to 35 watts is sufficient, the unit may be used as a complete transmitter for code and 'phone operation. This is an ideal exciter for a high-power amplifier.

This article is not confined to the construc-

*Technical Dept., QST. ¹ James Millen, "New Approach to Amateur Transmitter Design," QST, Mar., 1938.

tional details of this one unit, but rather is planned to give a few pointers which will be useful to the amateur building such a device to suit his individual needs. Since the majority of present-day amateurs participate in code operation alone, many would not be interested in the speech-amplifier equipment included in the arrangement pictured here. Indeed, of those interested in providing speech amplifier as well as r.f. exciter-transmitter, few consider the care and patience required to build both into a single panel and chassis justified by the operating convenience thus provided. Construction and adjustment of the unit shown in the illustrations required many hours of tedious work—in addition to parts, tubes, and crystals totaling \$150. Since the expense of this type of construction may prohibit its use in many cases, more economical methods of achieving the desired end also will be discussed.

R. F. STAGES

A single crystal oscillator stage may be used to deliver an output of approximately 25 watts on the crystal frequency. Why, then, should such an elaborate, expensive, and difficult-to-construct method of obtaining this output be used? The answer to this question lies in the ease with which band change, frequency change, and change from crystal to e.c.

oscillator with full output may be effected for operation in any of the five bands covered; in the fact that the output tube operates as a properly isolated Class-C amplifier and is thus suited to plate modulation if desired; and in the fact that each of the crystals provided may be used for operation on three to five crystal-controlled output frequencies. This last-named feature is an

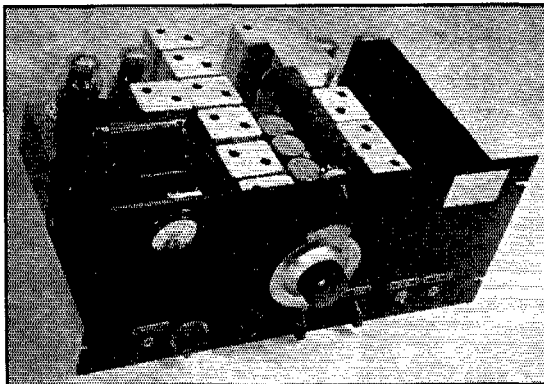

THE COMBINATION RADIO- AND AUDIO-FREQUENCY EXCITER-TRANSMITTER UNIT

The pointer knob at top center is the crystal selector-e.c.o. switch. To the right is the calibration curve, while below the switch is the calibrated band-spread tuning control. At the bottom of panel are, left to right: Microphone jack, audio gain control, meter circuit selector switch, band selector switch in center, send-receive switch, power switch, and key jack. The bleeder resistor of the 600-volt power supply is shown mounted on top of the audio output transformer, where air circulation is free. The push-pull coupling transformer which drives the 2A3 output tubes is located immediately behind the output transformer, and the 2A3 tubes are at rear of chassis behind the audio transformers. The two large transformers at right side of chassis have been removed from cases and painted black in order to facilitate cooling and at the same time retain a neat appearance.

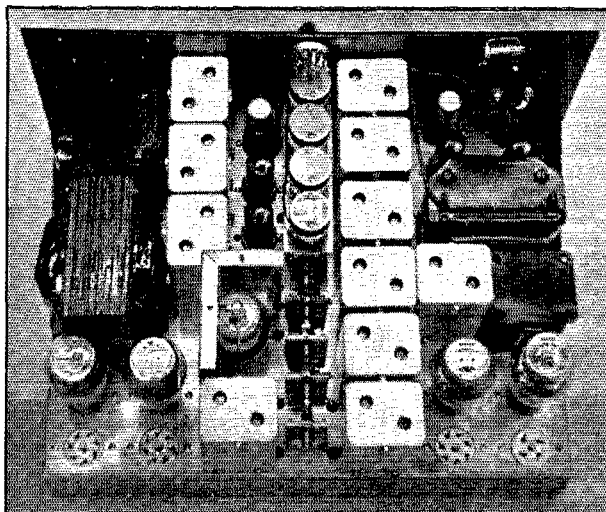

TOP VIEW OF THE COMBINATION UNIT

In this view, the 807 tube is shown with top of shield removed. This shield is used to supplement the bottom-of-tube shield mounted on the chassis. The two 5Z3 tubes are located at back of chassis behind the power transformers. The 6L7 tube is seen at the left of the condenser gang directly behind the panel, and is followed by the 6Y6, 6N7, and the other 6N7 r.f. tube which is hidden by the 807 shield. The four crystal sockets are mounted on an aluminum plate which is in turn mounted on top of the first four condenser sections. The 6J7 speech input tubes are located directly behind the panel beneath the meter, and the tubes between the 6J7's and the audio output transformer are the 6N7 push-pull speech amplifiers. It will be noted that the chassis is laid out primarily for correct wiring of the r.f. stages, with thought given also to placement of the speech amplifier transformers as far as conveniently possible from the power transformers. The plug-in tanks in the row at left are, from panel toward rear of chassis: 80-meter doubler plate tank, 20-meter doubler tank, and 10-meter doubler tank. In the row of six, beginning at panel, there are: 160-meter e.c. oscillator grid, crystal oscillator-buffer plate, 40-meter doubler plate, 80-meter amplifier tank, 40-meter amplifier, and 10-meter amplifier tank. The 20-meter amplifier tank is located at rear of chassis behind the 807 tube, and the 160-meter amp. tank is located beside the push-pull audio transformer. The three 7-prong sockets at rear of chassis are those for power and output cables, as shown in the diagrams, and the 4-prong socket is included for making the 300-volt power supply available for a receiver.

important one, for the maximum value in a crystal may only be realized when this crystal may be used to control output not only on the crystal frequency, but on harmonic frequencies in the amateur

bands as well. A desirable characteristic of such an r.f. oscillator-amplifier arrangement as that shown is the fact that the crystals are operated in a lightly-loaded tetrode oscillator with plate voltage never exceeding 300 volts, so that there is no danger of injury to the crystals.

To go back once more to the question of a single-tube exciter, suppose that some such tube as an RK39 or 807 were used as a band-switched, crystal-e.c. oscillator. Tuned plate tanks and grid tanks could be provided for e.c. operation, and one crystal could be used on each band. With this system, representative power output of the oscillator, crystal-controlled, would be in the neighborhood of 5 watts on 10 meters, 10 watts on 20 meters, and higher output power on the lower-frequency bands. For good frequency stability, the power of the e.c. oscillator probably would not exceed 5 watts on any band. Furthermore, the oscillator would have to be adjusted on five bands for stable e.c. operation, rather than on one. These considerations point to one type of arrangement—oscillator on one low-frequency band, and successive doublers for operating

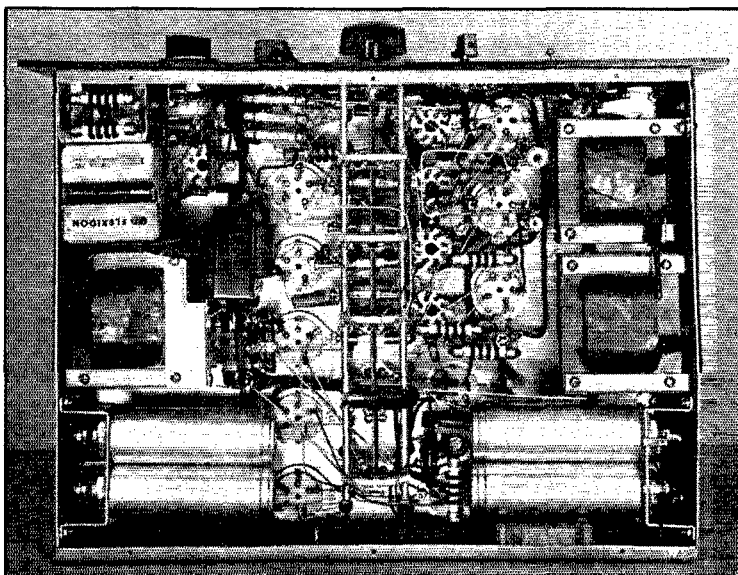

BOTTOM VIEW OF THE AUDIO-R.F. CHASSIS

Filter chokes and condensers are mounted along each side beneath the chassis. The two r.f. chokes at the input of the speech amplifier are shown in their shield can which is mounted around the back of the microphone jack. The bottom plate for the chassis completes the shielding of this unit.

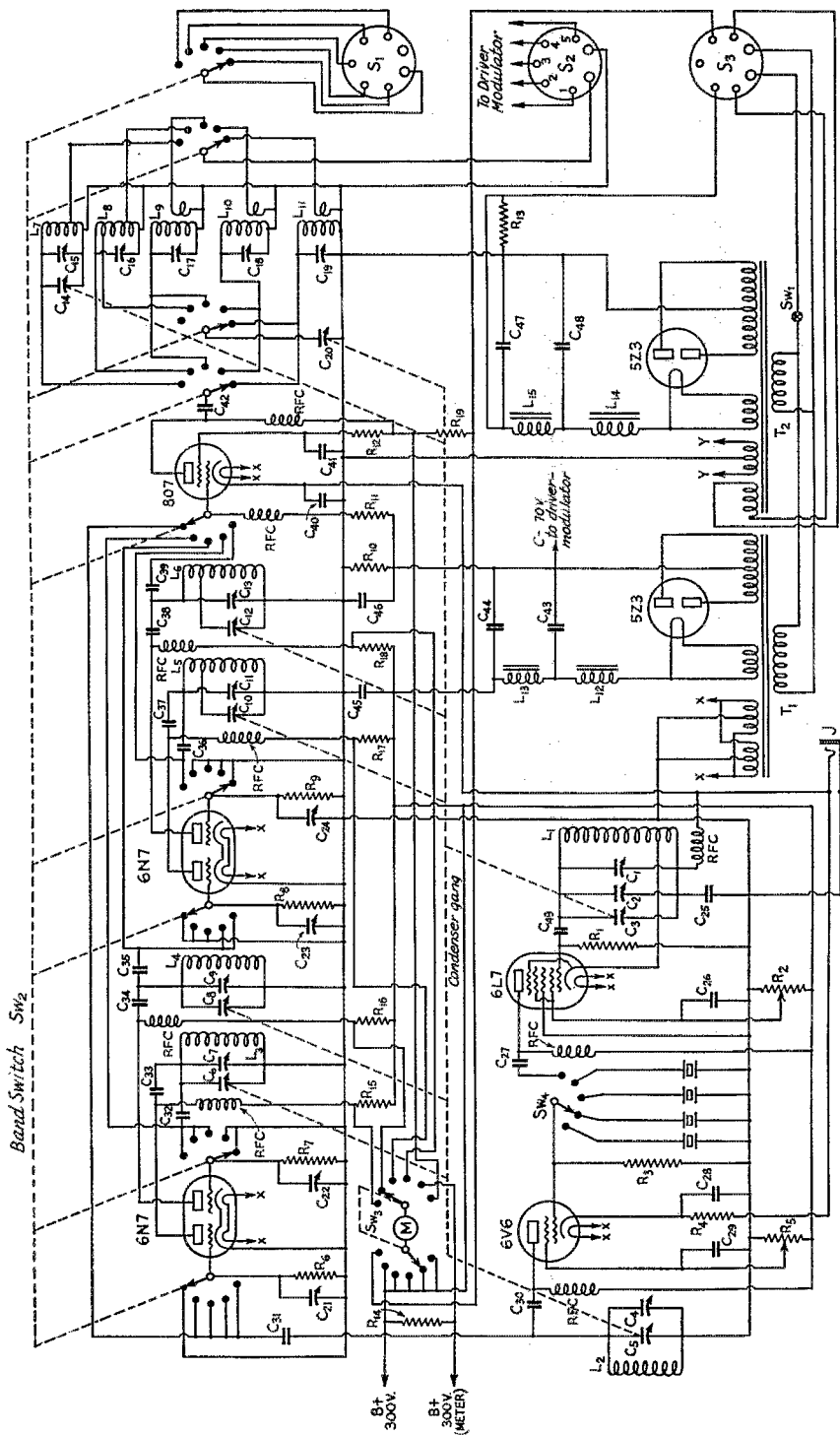

FIG. 1—CIRCUIT OF R.F. EXCITER AND POWER SUPPLIES

- C₁—200- μ f.d. fixed condenser (two Slickles)
- C₂—50- μ f.d. variable condenser (both sections of tank)
- C₃—50- μ f.d. variable condenser (both sections of tank)
- C₄—50- μ f.d. variable condenser (both sections of plug-in unit)
- C₅—11-885 100- μ f.d. condensers parallel connected and inserted in tank unit)
- C₆—50- μ f.d. variable condenser (both sections of tank)
- C₇—25- μ f.d. variable condenser (single section of tank)
- C₈—5-25-henry, 200-ma. stringing chokes
- C₉—5-25-henry, 200-ma. stringing chokes
- C₁₀—50- μ f.d. variable condenser (both sections of tank)
- C₁₁—50- μ f.d. variable condenser (both sections of tank)
- C₁₂—50- μ f.d. variable condenser (both sections of tank)
- C₁₃—50- μ f.d. variable condenser (both sections of tank)
- C₁₄—50- μ f.d. variable condenser (both sections of tank)
- C₁₅—50- μ f.d. variable condenser (both sections of tank)
- C₁₆—C₁₇—25- μ f.d. variable condenser (single section of tank)
- C₁₈—50- μ f.d. variable condenser (both sections of tank)
- C₁₉—50- μ f.d. variable condenser (both sections of tank)
- C₂₀—50- μ f.d. variable condenser (both sections of tank)
- C₂₁—50- μ f.d. variable condenser (both sections of tank)
- C₂₂—50- μ f.d. variable condenser (both sections of tank)
- C₂₃—50- μ f.d. variable condenser (both sections of tank)
- C₂₄—50- μ f.d. variable condenser (both sections of tank)
- C₂₅—50- μ f.d. variable condenser (both sections of tank)
- C₂₆—50- μ f.d. variable condenser (both sections of tank)
- C₂₇—50- μ f.d. variable condenser (both sections of tank)
- C₂₈—50- μ f.d. variable condenser (both sections of tank)
- C₂₉—50- μ f.d. variable condenser (both sections of tank)
- C₃₀—50- μ f.d. variable condenser (both sections of tank)
- C₃₁—50- μ f.d. variable condenser (both sections of tank)
- C₃₂—50- μ f.d. variable condenser (both sections of tank)
- C₃₃—50- μ f.d. variable condenser (both sections of tank)
- C₃₄—50- μ f.d. variable condenser (both sections of tank)
- C₃₅—50- μ f.d. variable condenser (both sections of tank)
- C₃₆—50- μ f.d. variable condenser (both sections of tank)
- C₃₇—50- μ f.d. variable condenser (both sections of tank)
- C₃₈—50- μ f.d. variable condenser (both sections of tank)
- C₃₉—50- μ f.d. variable condenser (both sections of tank)
- C₄₀—50- μ f.d. variable condenser (both sections of tank)
- C₄₁—50- μ f.d. variable condenser (both sections of tank)
- C₄₂—50- μ f.d. variable condenser (both sections of tank)
- C₄₃—50- μ f.d. variable condenser (both sections of tank)
- C₄₄—50- μ f.d. variable condenser (both sections of tank)
- C₄₅—50- μ f.d. variable condenser (both sections of tank)
- C₄₆—50- μ f.d. variable condenser (both sections of tank)
- C₄₇—50- μ f.d. variable condenser (both sections of tank)
- C₄₈—50- μ f.d. variable condenser (both sections of tank)
- C₄₉—50- μ f.d. variable condenser (both sections of tank)
- C₅₀—50- μ f.d. variable condenser (both sections of tank)
- C₅₁—50- μ f.d. variable condenser (both sections of tank)
- L₁—50,000-ohm, 1-4 watt carbon
- L₂—50,000-ohm, 1-4 watt carbon
- L₃—50,000-ohm, 1-4 watt carbon
- L₄—50,000-ohm, 1-4 watt carbon
- L₅—50,000-ohm, 1-4 watt carbon
- L₆—50,000-ohm, 1-4 watt carbon
- L₇—50,000-ohm, 1-4 watt carbon
- L₈—50,000-ohm, 1-4 watt carbon
- L₉—50,000-ohm, 1-4 watt carbon
- L₁₀—50,000-ohm, 1-4 watt carbon
- L₁₁—50,000-ohm, 1-4 watt carbon
- L₁₂—50,000-ohm, 1-4 watt carbon
- L₁₃—50,000-ohm, 1-4 watt carbon
- L₁₄—50,000-ohm, 1-4 watt carbon
- L₁₅—50,000-ohm, 1-4 watt carbon
- M—0-200 d.c. milliammeter
- R₁—50,000-ohm, 1-4 watt carbon
- R₂—1-4 watt carbon
- R₃—50,000-ohm, 1-4 watt carbon
- R₄—50,000-ohm, 1-4 watt carbon
- R₅—50,000-ohm, 1-4 watt carbon
- R₆—50,000-ohm, 1-4 watt carbon
- R₇—50,000-ohm, 1-4 watt carbon
- R₈—50,000-ohm, 1-4 watt carbon
- R₉—50,000-ohm, 1-4 watt carbon
- R₁₀—50,000-ohm, 1-4 watt carbon
- R₁₁—50,000-ohm, 1-4 watt carbon
- R₁₂—50,000-ohm, 1-4 watt carbon
- R₁₃—50,000-ohm, 1-4 watt carbon
- R₁₄—50,000-ohm, 1-4 watt carbon
- R₁₅—50,000-ohm, 1-4 watt carbon
- S₁—Single-pole, single-throw toggle power switch
- S₂—Large 7-prong socket, r.f. and audio
- S₃—Large 7-prong socket, power connector
- Sw₁—Single-pole, single-throw toggle power switch
- Sw₂—Band Switch
- Sw₃—Single-pole, single-throw toggle power switch
- T₁—50,000-ohm, 1-4 watt carbon
- T₂—50,000-ohm, 1-4 watt carbon

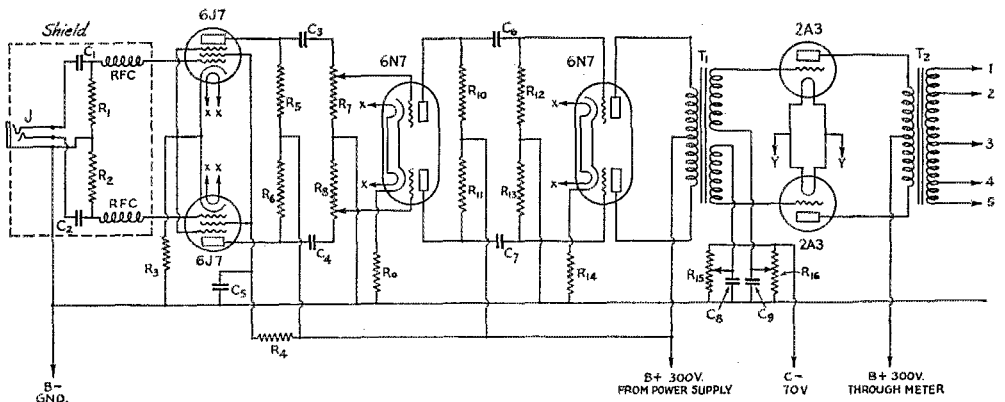

FIG. 2—CIRCUIT OF THE ALL-PUSH-PULL AUDIO SYSTEM

C₁, C₂—0.002- μ fd. mica, 600-volt.
 C₃, C₄, C₆, C₇—0.01- μ fd. paper tubular, 600-volt.
 C₅, C₈, C₉—1- μ fd. paper, 600-volt.
 J—Three-wire jack.
 R₁, R₂—2-megohm, 1/2-watt carbon.
 R₃—600-ohm, 1-watt carbon.
 R₄—0.6-megohm, 1-watt carbon.

R₅, R₆, R₁₀, R₁₁—0.25-megohm, 1-watt carbon.
 R₇, R₈—2-gang 250,000-ohm potentiometer.
 R₉—2000-ohm, 1-watt carbon.
 R₁₂, R₁₃—0.5-megohm, 1-watt carbon.
 R₁₄—700-ohm, 1-watt carbon.

R₁₅, R₁₆—5000-ohm, 5-watt wire-wound with sliders.
 T₁—Push-pull input transformer for driving 2A3 tubes.
 T₂—Driver transformer for coupling 2A3 plates to grids of Class-B tubes.

output. In the unit of Fig. 1 this is accomplished by a gang of 8 condenser sections. One of these is a high-capacity section in the grid circuit of the e.c. oscillator, and another is in the plate circuit of the 6V6 crystal-oscillator buffer-amplifier stage. Four sections of the condenser are used to tune four doublers simultaneously, while the remaining sections tune the amplifier tank circuits. The alternative would be use of a band-spread condenser on the e.c. oscillator, a variable condenser tuning the plate circuit of the 6V6 stage (mounted on the panel so that readjustments could be made for crystals of different frequencies, and for maximum output when using the e.c. oscillator) and, if maximum output and efficiency at all frequencies were desired, readily available tuning controls for each of the doubler and amplifier tanks. To adjust to a desired frequency in the 10-meter band, it would then be necessary to switch the band-change knob to the proper position and to adjust six or seven condensers, depending on whether crystal- or self-controlled operation were desired. While this is not a too-great inconvenience at some times, it often proves too lengthy for most efficient operating. In any event, the latter and more cumbersome method may be installed at a saving of \$10 to \$30, the actual amount depending on the type of condensers used for the gang unit, on the type of tank coils and condensers used, and on the number of bands covered.

The gang-tuning system as used in the exciter-transmitter of the illustrations consists of two dual Trim-air condensers followed by four single Trim-air midgets. The first section of the dual condenser at the panel is replaced by a set of plates and spacers taken from a 75- μ fd. single condenser. The seven remaining ganged sections are 25 μ fd. each. Thus, the inductance used for 160-meter e.c. oscillator grid circuit is equal to one-third the inductance values in the other 160-meter tanks, and the total capacity is three times as great, resulting in stages which remain resonant with tuning readjustments. It will be noted that in all but three of the circuits the band-spread gang condenser sections are connected in parallel with the padder condensers. This may be done with equal gang capacities if the total circuit capacities are all equal. This means that if frequency doubling is to be accomplished, the inductance of a doubler plate circuit must be one-fourth that of the preceding tank circuit.

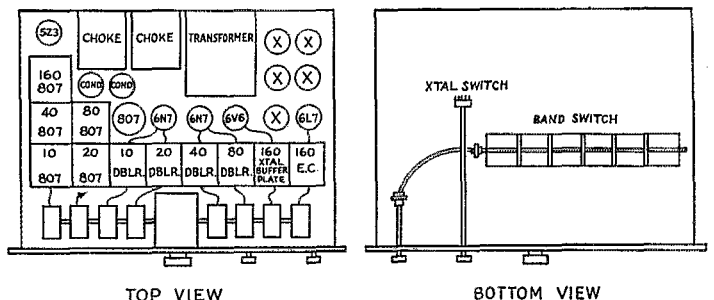

FIG. 3—A PRACTICAL LAY-OUT FOR R.F. EXCITER AND POWER SUPPLY

The condenser sections should be rigidly coupled. The tanks may be either manufactured units or home-built assemblies such as shown in Fig. 4.

The disadvantage of this system, if carried through a large number of successive doubler stages, is the fact that the high-frequency stages, where efficiency is of the greatest importance, must have relatively high-capacity tanks. In this set, the difficulty was partially overcome by making use of extremely low-capacity circuits at the lower frequencies, so that those at the 20- and 10-meter bands were conventional values for those frequencies. In addition, it will be noted that the gang sections for the 10- and 20-meter doublers, and for the 20-meter amplifier tank, are connected across tapped portions of the respective coils. Although this method does not result in stages tuning exactly together, it is sufficiently accurate for the width of the narrow 20-meter band, and for the last doubler stage where excitation of succeeding doublers need not be sacrificed by reduced output from an off-resonant circuit.

With so many condenser sections ganged for single control some mechanical loss, particularly due to use of flexible couplings, is inevitable. Consequently, it is important that the condenser which tunes the e.c. oscillator not be separated from the calibrated dial by anything but the most rigid type of condenser shaft or coupling. This

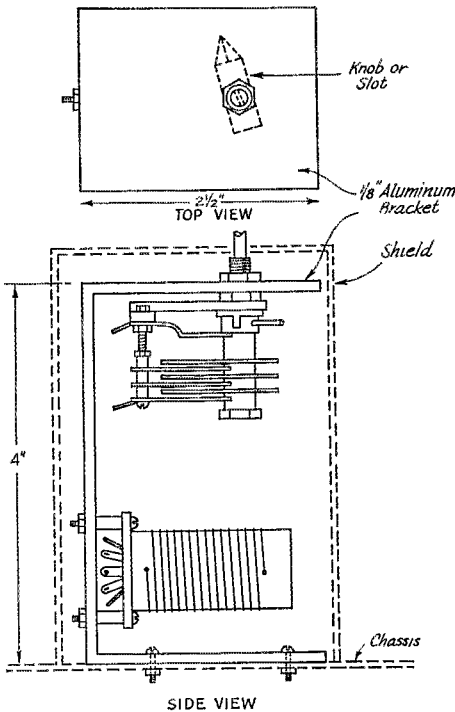

FIG. 4—AN EASILY-CONSTRUCTED AND ACCESSIBLE TANK ASSEMBLY

By removing the box shield from above the coil and condenser, the coil may be pulled from the socket (or unscrewed, if a fixed coil mounting to the bracket is used) to be readjusted.

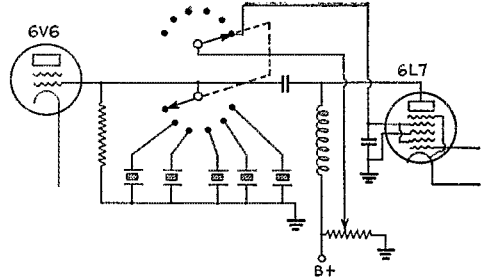

FIG. 5—AN EFFECTIVE METHOD OF SWITCHING IN E.C. OSCILLATOR OR ANY OF FIVE CRYSTALS

section, in the interests of good electrical layout, could be third or even fourth from the dial if a continuous shaft is used, or if the shafts are carefully aligned and connected by means of metal bushing-type couplers.

The grid tank capacity of the e.c. oscillator is made up of two silvered-mica fixed condensers of

COIL DATA

- L₁—35 turns No. 28 enameled, close-wound; cathode tap located 8 turns from ground; length of winding, 1/2 inch.
- L₂—80 turns No. 28 enameled, close-wound; 1 1/8-inch winding length.
- L₃—44 turns No. 22 enameled, close-wound; 1 1/4-inch winding length.
- L₄—22 turns No. 22 enameled, spaced to 1 1/4-inch winding length.
- L₅—11 turns No. 22 enameled, spaced to 1-inch winding length; tap located 10 turns from ground.
- L₆—4 turns No. 22 enameled, spaced to 1/2-inch winding length; tap located 3.5 turns from ground.
- L₇—3 turns No. 22 enameled, spaced to 1/2-inch winding length; tap located one turn from ground.
- L₈—11 turns No. 22 enameled, spaced to 1-inch winding length; link tap located 2 turns above ground; band-spread tap located 10 turns above ground.
- L₉—22 turns No. 22 enameled, spaced to 1 1/4-inch winding length; 3-turn link coil No. 22 enameled, interwound with ground end.
- L₁₀—44 turns No. 22 enameled, close-wound; 1 1/4-inch winding length; 5-turn link coil No. 22 enameled, wound over ground end.
- L₁₁—80 turns No. 28 enameled, close-wound; 1 1/8-inch winding length; 8-turn link coil No. 22 enameled, wound over ground end.

100 μfd . each, the two 25- μfd . condensers normally supplied with the type of condenser-coil tanks used, and the parallel capacity of the band-spread condenser. With this combination of capacities, together with the distributed capacity of the coil and the capacity of the tube and circuits, the tuning range of the oscillator is just limited to 1750 to 2000 kc., with very small margins at the extremes of the dial. The two 25- μfd . condensers are used to center the tuning range on the calibrated dial.

For the other tanks, one or both of the 25- μfd .

(Continued on page 110)

Radio Control of Powered Models

By Clinton B. DeSoto,* WICBD

APPLYING successful radio control to a powered plane requires that the control simulate, insofar as possible, the equivalent actions of a pilot in a regular ship. The use of at least two control elements—rudder and elevator, in this case—actuated by continuously reversible electric motors approximates this condition.

The use of RK-62's² in the receiver minimizes ignition difficulties since, being carrier-operated, these tubes as detectors are not responsive to audio frequency disturbances.

D.C. MOTORS POWER CONTROLS

A survey of the miniature d.c. motor field led to the choice of a type made by the Utah Radio Products Corp. of Chicago for use in automobile radio push-button tuning systems. The design is ingenious, rugged, dependable. The motors weigh 6 ounces each. Two flashlight cells will operate them for a short time, although three cells in series or a heavier 3-volt battery are preferable for positive starting over a period of time.

Several possible methods of reducing the nominal 4000 r.p.m. speed of these motors to the comparatively slow movement required on the controls were considered, but in the end conventional clock-work gear trains were used. The construction of such a gear train is shown in Figure 1.

The motor and gears are assembled as a unit on sheet aluminum mounting plates. These plates must be accurately drilled and the assembly must be precise to avoid trouble with gear slippage or binding.

The gears are standard clock wheels throughout, and were obtained from the E. Ingraham clock works in Bristol, Conn. Similar wheels can be ordered either direct or through a local clock repairer by specifying the number of teeth and approximate diameter.

* Assistant Secretary, A.R.R.L.
¹ DeSoto, "Ham Radio and Models," *QST*, September, 1938, p. 38.

² Hull, "New Gear for Radio Control Systems," *QST*, July, 1938, p. 44.

Since clock wheels do not correspond with engineering gear standards, it is difficult to secure an exact match for the built-in pinion on the Utah motor. The nearest approach to the pinion, which is 96 diametral pitch, is a $\frac{5}{8}$ -inch wheel of 93 diametral pitch (30 teeth per peripheral inch). Alternatively, an ordinary electric power meter contains a wheel of just the right size. All the other wheels specified run 20 teeth per inch with the exception of the last gear in the elevator assembly. Since this has a substantial load, it and

the driving pinion are of the 15-teeth per inch size.

Small brass collars are located on the shafts so as to serve as bearings running against the mounting plates, keeping the wheels centered. In the case of all wheels except the last one in each train (which is soldered) a pressure fitting on the shaft is sufficient.

The gear trains are assembled with spacers, cut from $\frac{1}{4}$ -inch aluminum tubing, and bolts of threaded $\frac{1}{8}$ -inch alu-

minum rod. In this way the weight is kept down to $1\frac{1}{2}$ -oz. total per unit; the gross weight for motor and gear box is $7\frac{1}{2}$ oz.

With light oil on all bearings the train should move so freely as to permit driving the motor from the first gear inside the box by finger pressure.

RUDDER CONTROL

The motors as supplied by Utah are fitted with a built-in clutch assembly designed to eliminate over-run in tuning systems. The use of this clutch is neither necessary nor desirable in the control system. In the case of the rudder control motor it is held "in" permanently by inserting a spacer on the drive shaft inside the housing.

The gear-box assembly bolts are made long enough to serve in mounting the motor unit on a plywood bulkhead located in the fuselage at the rear of the cabin. The $\frac{1}{8}$ -inch shaft of the final gear extends through a 2-inch hole in the bulkhead. Driven onto this shaft by a forced fit is a brass collar, which is further secured by a light pin going through the

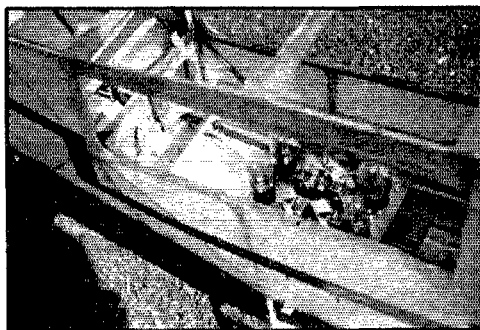

CABIN INTERIOR, SHOWING LOCATION OF CONTROL GEAR

The receiver chassis is readily accessible through the side window for tuning adjustments.

This is the story on radio control as applied to a gas-powered model airplane which was promised in September *QST*.¹

shaft. A small steel arm is forced over the turned-down outer end of this collar, which is then swedged for additional strength. At the end of this arm a $\frac{1}{8}$ -inch steel pin is threaded into a hole until it is tight, whereupon the end is peened down to lock it in place.

The driving arm operates a small rudder bar, which moves the control cable along over pulleys and back to the rudder horns. This "cable" is actually fine steel or brass wire up to the pulleys, where it is tied into a short length of good quality casting line.

ELEVATOR CONTROL

In the case of the elevator motor, owing to the horizontal installation gravity automatically keeps the clutch engaged. The assembly is supported in the fuselage by a narrow plywood cross-piece. The motor is braced against the rudder assembly to reduce horizontal distortion caused by twisting of this support.

The $\frac{1}{8}$ -inch shaft of the driving gear is fitted with a brass collar and steel arm and pin as in the rudder assembly. The end of the pin is drilled to receive a small cotter pin. The end of a length of $\frac{3}{16}$ -inch aluminum tubing, flattened and drilled with a $\frac{1}{8}$ -inch hole, is secured on this pin with washers and the cotter pin.

The far end of the aluminum control shaft is also flattened and drilled, in the vertical plane. It is connected to a fork of aluminum sheet, the fork being in turn riveted to the center of the elevator assembly. All tolerances must be kept small so as to reduce looseness and wobble.

RECEIVERS

Four radio channels are required to manipulate the two controls with instantaneous reversal in each case. The four 1-tube receivers are grouped on a plywood chassis 8 inches square.

Apart from tuning, there are two controls in these receivers—antenna coupling and filament voltage—and each must be adjusted carefully.

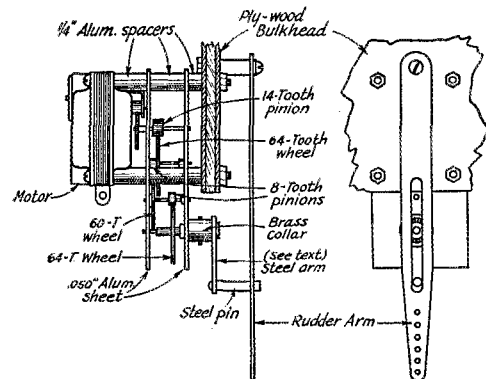
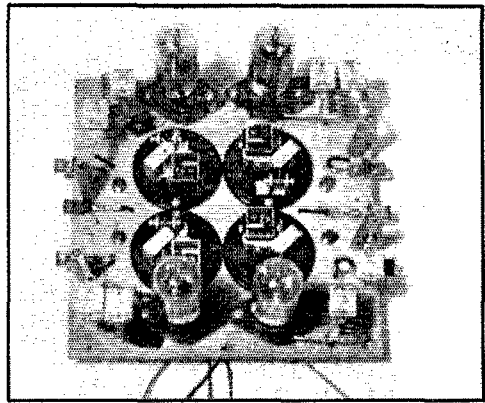

FIG. 1—RUDDER MOTOR AND GEAR TRAIN DETAIL



THERE ARE FOUR RECEIVERS, BUT THE CHASSIS IS JUST EIGHT INCHES SQUARE

The parallel tuning and series antenna condensers are visible beside each tube, with the relays at center. Tuning is accomplished by insulated screwdriver through the cabin windows.

To start with, however, the plate voltage must be right. Many RK-62's work satisfactorily with a straight 45 volts on the plate, but some perform best with lower voltages—30 to 40 volts. In that case the "B" battery container should be opened up (an easy matter with the small portable types) and the proper tap wired in on the basis of experiment.

With the correct plate voltage, the filament voltage can usually be set at 2.2 volts and forgotten. However, some adjustment within the permissible range (2 to 2.6 volts) may be necessary for optimum results.

That leaves antenna coupling the really important adjustment. The antenna should be the proper length, to start with. This means not less than 3 or 4 feet, with 5 or 6 preferable. (In the present ship one antenna is run along the bottom of the fuselage, one along the top, and the others in each wing. Antennas of neighboring receivers should be kept as widely separated as possible.)

The maximum plate current should not be permitted to exceed perhaps 2.5 ma. Under average conditions the optimum operating figure is about 1.7 or 1.8 ma. If all adjustments are correct even a weak signal will cause a change to 0.5 ma. or less. If a sufficiently high grid leak resistance is used the cut-off can be made substantially complete, but then the time constant becomes objectionable.

Although the receivers can be tuned by watching the relays alone, it is best to make provision for inserting a tuning meter in each plate circuit—even if this consists merely of jumper connections, as shown in the wiring diagram. A point to be remembered is always to tune up *after* batteries are charged, never before.

Speaking of batteries, the types found most useful in connection with this installation are the

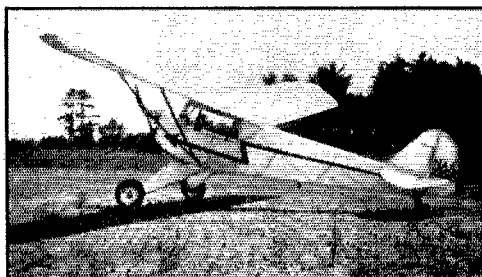

THE RADIO-CONTROLLED GAS MODEL

14-ft. span, 8½ ft. long overall, weight 28 lbs., powered by a special Forster Bros. 2-cylinder opposed type motor rated at ¾ hp.

Burgess T2FL for filament supply (3 volts, 8 oz.), the Burgess X30FL 45-volt 13-oz. "B," and the Burgess T3BP (3 volts, 12 oz.) for the motor drive. Three standard flashlight cells (4.5 volts, 10½ oz.) are also suitable for the motor. The battery combination with the minimum feasible weight would be two pairs of flashlight cells for filaments and motors and the Burgess W30FL 8.5-oz. 45-volt "B," a net weight of 1 lb. 6.5 oz.

Any transmitter that will give a reasonably stable signal at four points in the 56-Mc. band will do. High power is not required, although at least 5 to 10 watts input is recommended.

The transmitter originally used employed four RK-34's as self-excited tuned-grid tuned-plate oscillators, the plate tanks consisting of 24-inch long pairs of ½-inch copper tubing spaced about ¾-inch, tuned with 35-μfd. midjet variable condensers. Sliding taps connected to ¾-wave spaced feeders and center-fed half-wave antennas.

This transmitter worked satisfactorily, but the interlocking of grid and plate controls and antenna coupling made it difficult to spot frequencies precisely when setting up in the field. So a new transmitter was built, using the RK-34's as push-pull doublers with conventional low-*C* coil-condenser tuned circuits. Driving them are four 6L6G's as electron-coupled oscillators on 14 Mc., doubling in their plate circuits to 28 Mc. Inductive coupling is used interstage. With "hand-spread" oscillator grid tuning circuits it is possible to calibrate the transmitters quite accurately.

The transmitting antennas are of the cheapest "whip" type as supplied for automobile radios. They telescope to 24 inches and open to 52. Two 8-foot "masts" of 1-×2-inch wood have simple fittings at the tops permitting connection of four of these antennas pointing in as many directions. Feeders are connected to opposite pairs, of course, and run to the transmitter. The stakes are set in the ground as far apart as the feeder length permits, the wires being kept taut.

The control box is mounted on a light camera tripod. Telephone-type key switches, which have an "on" position each side of neutral, are used. One connects in either of two transmitters for

rudder control "left" and "right," while the other controls the remaining two transmitters for elevator control "up" and "down." The "stick" nature of the handles on these switches makes visualization of the response easier than with any rotary wheel or key device yet tried. A 50-foot cable connects the control box to the transmitters.

In tuning up it is necessary to remember merely that the relays are switches which turn the motors off and on, and that these switches are "open" only when the receivers are idling—that the motors turn either when a signal comes along or the receiver plate current is off.

The best procedure is to set one of the previously-calibrated transmitters on 56 Mc. and then tune one of the receivers to it. Repeat this process at 57.3, 58.7 and 60 Mc. Then go through the positions with the control box, checking several times under a variety of conditions for reliability.

In handling the controls the same basic precaution as in regular airplane piloting applies: Do not over control. A very small movement will change the angle of flight considerably. Even though the total travel of both elevator and rudder has been kept small it is more than can normally be used. The timing of the controls has been worked out so as to enable accurate setting of small angles of arc; yet the total transmit time per quadrant of 1 to 1½ seconds enables quite rapid shift in direction when necessary.

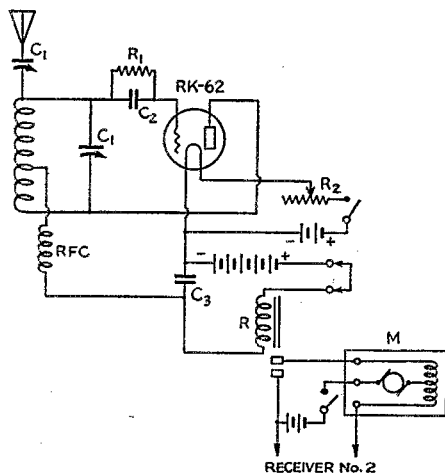

FIG. 2—WIRING DIAGRAM OF ONE OF THE FOUR RECEIVING UNITS

The others are identical, using common batteries and switches.

C₁—3-30-μfd. midjet mica trimmer condensers.

C₂—100-μfd. midjet mica fixed condenser.

C₃—0.5-μfd., 200-volt tubular paper fixed condenser.

R₁—10-megohm, ½-watt fixed resistor.

R₂—30-ohm midjet rheostat.

RFC—40 turns No. 30 d.s.c. wire, wound on IRC molded 1-megohm ½-watt fixed resistor, using its pigtailed for leads.

L—8 turns No. 14 tinned copper wire, ½-inch diameter, turns spaced diameter of wire.

R—8000-ohm sensitive relay (Sigma 2-A).

M—Reversible miniature d.c. motor (Utah Z-30-S).

Some Thoughts on Rotary Beam Antennas

A Lightweight and Inexpensive Supporting Frame Adaptable to Several Types of Arrays

By Arthur H. Lynch,* W2DKJ

SO MUCH has been written and discussed over the air, among amateurs, regarding the design, construction and operation of rotary beams, that it would seem that any further conversation on the subject would be practically useless. The same might be said of matching stubs, transmission lines and the various forms of mechanical structures which have become so popular. At the outset, let us say that the fellow who expects to find anything very revolutionary in this text will be wasting his time. It is not our purpose to provide any thrills, but we do believe that a few practical ideas may be had from our own experience and that of others who have been using beams to good advantage.

Little doubt remains that the simple beam which has been so thoroughly described by John Kraus,¹ W8JK, is a much more satisfactory antenna than any of the simpler affairs which were used before he showed how easy it was to build and tune a good beam. The same may be said of Mims's Signal Squirter,² and some of the close-spaced arrays so well covered by Brown,³ Romander,⁴ Roberts⁵

and others. Nearly every one of them has been duplicated many times by other hams, in practically every part of the world. There is no doubt

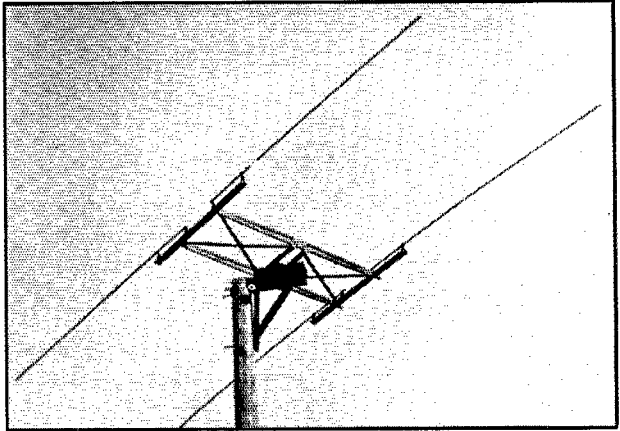

THE "SJK" TYPE OF BEAM, USED AT W2AZ TO REPLACE THREE FIXED BEAMS WHICH WERE TWICE AS LONG AND TWENTY-FIVE FEET HIGHER

This little rotary has been WAC several times since its erection, July 4th, of this year. It is offset from the top of a 60-foot telephone pole. Except for the minor changes in the struts, the supporting structure is identical that shown in Fig. 3.

about their efficacy, but there have been many who have been more than a little disappointed with the results they have been able to get.

Taking it for granted that the average ham, particularly the fellow who inhabits the 20-meter 'phone band, has a pretty fair idea of what it is all about and that he can actually follow the instructions which have been so ably set forth, we believe that the principal reason for dissatisfaction is found in the fact that the new beam user expects too much. To make our point a bit clearer, let's make one statement and then analyze it a bit. Then, perhaps, the other points will stand out a little more plainly.

One of the beams shown in the diagrams is a bidirectional affair, which may be either fixed or rotary. It has a gain of about 4.5 db over the ordinary half-wave dipole, and it will be recognized at once as being a typical "SJK" affair. The particular one, from which many of our facts have been drawn, has been in operation at W2AZ since the fourth of July. One of the receivers used at

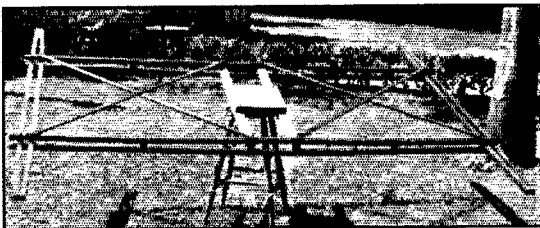

LOOKING AT THE W2DKJ UNIT FROM THE BOTTOM
The platform is upside down in this view, to show how all the members have been joined.

that station is an HRO, which has been very accurately calibrated in microvolts. Here is the statement: In an actual test with LU8AB, the measured signal put the meter needle against the pin, when the beam was smack on him, but his

signal strength was so weak when the beam was turned 90 degrees in either direction, that it could not be observed on the meter.

That statement is as true as gospel, but it is only half the truth. It is the kind of enthusiastic

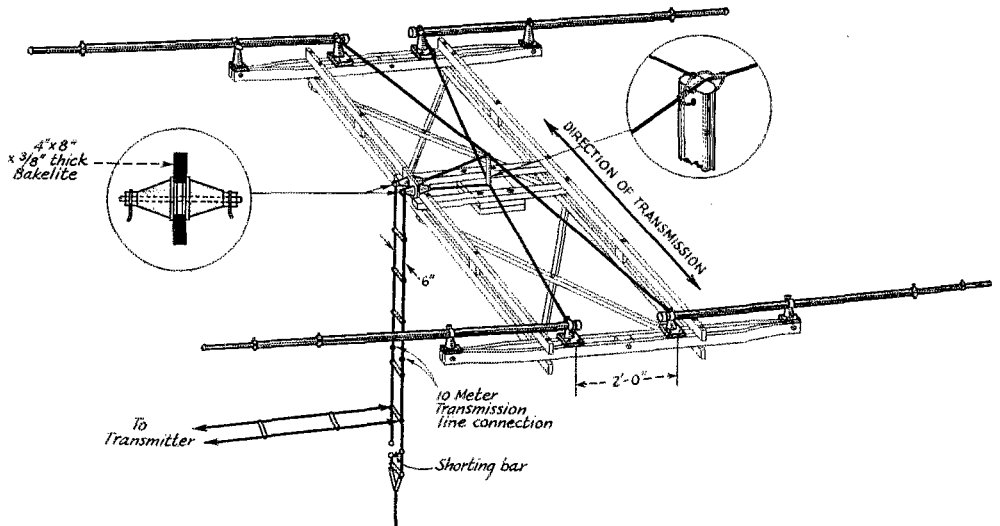

FIG. 1—BIDIRECTIONAL ANTENNA AT W2AZ

This is an actual drawing of the electrical arrangement used at W2AZ, on twenty-meter 'phone. The beam will have a bit better gain when used on ten meters, and it only is necessary to open the shorting bar on the matching stub and run the transmission line up to the points indicated by the dots. The shorting bar is used for twenty-meter operation.

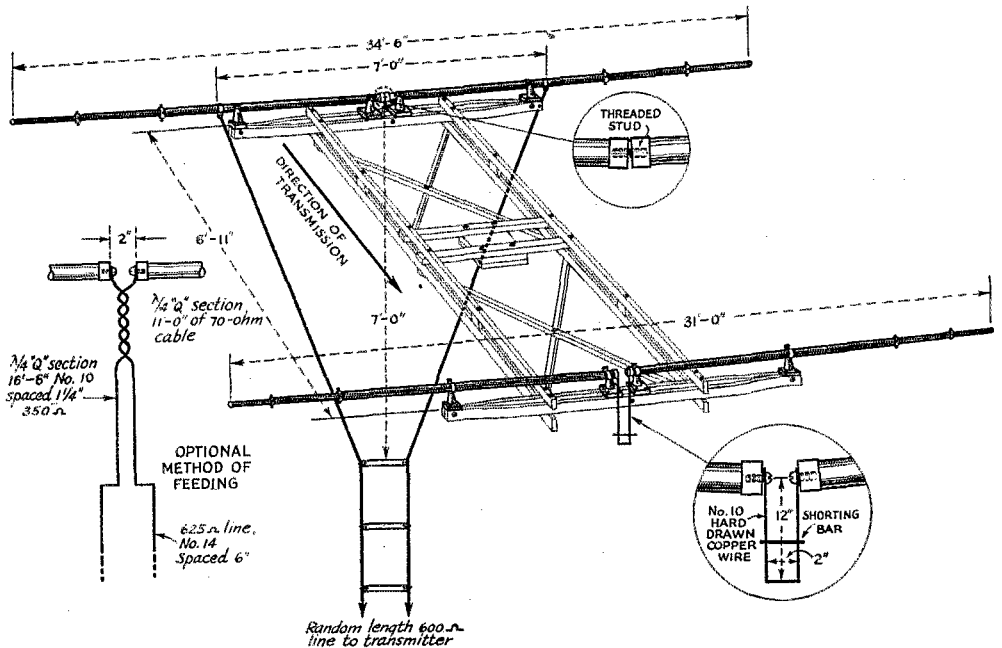

FIG. 2—UNIDIRECTIONAL BEAM ANTENNA

This is a compromise type incorporating some of the principles outlined by Brown, simplified by Roberts, and applying a few additional kinks suggested by the present author.

statement which has caused much of the misunderstanding of what we can and what we can't expect from these new marvels. At the time that particular test was made, conditions between New York and Buenos Aires were not what would be called "open" and the beam really had a chance to do its stuff. Let's suppose that we were to let the statement go at that and began casting that kind of oil on the troubled waters, giving all the dope on the construction of the beam itself, the matching stub and the transmission line. If the same sort of results were not experienced by the fellows who duplicated it they would have fair reason to assume that they were saps or that we were a liar.

Actually, neither of these things would, necessarily, be true. Most of us forget that the various bands play some funny tricks on us, particularly when we are really out for the "far corners." While the result we have mentioned was an actual occurrence, it is not average—not by a very long shot. If, for instance, conditions between B.A. and N.Y. began to improve, we should have found that the beam would be less and less efficacious and it is quite likely that a wide-open condition between the two cities, when low-powered rigs, hooked to ordinary aerials, on each end were bringing reports of S9, that we could swing the old beam around as much as we liked and the signal level would be about the same or not much different. It is doubtful that any condition would arise which would quite come into this category, but the point is that we would not be getting anything like the results we thought a good beam should be capable of giving compared to our ordinary aerial, and would be somewhat less than satisfied.

Let's figure, then, that there is still room for a

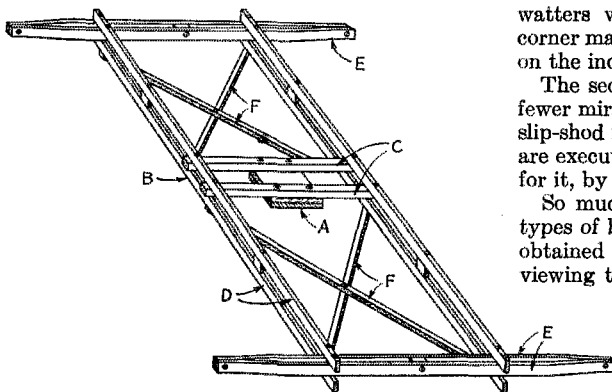

FIG. 3—MECHANICAL DETAILS OF THE SUPPORTING STRUCTURE

The construction is explained in the text. Note how additional rigidity is obtained by means of the bowing of the sections marked "E." Dimensions given in text.

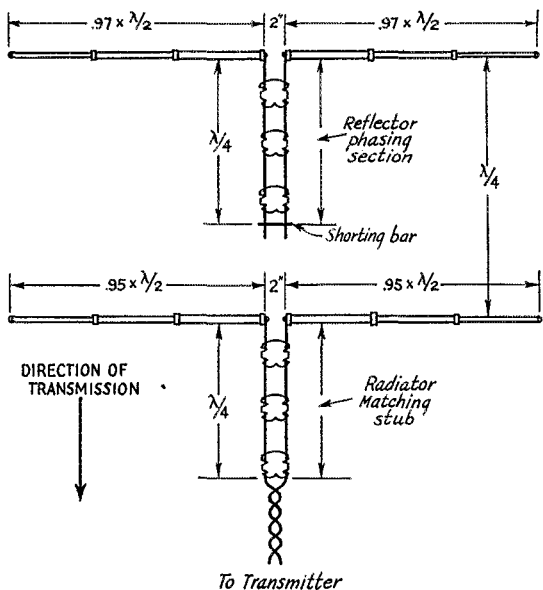

FIG. 4—TEN-METER 4-ELEMENT ARRAY USING TWO HALF-WAVES IN PHASE AND TWO HALF-WAVE REFLECTORS

Using the same supporting structure, without making any important changes in the dimensions, it is possible with the use of rigid telescopic elements to build a uni-directional, multi-element array which has considerable gain. Approximate dimensions for 30-Mc. reflectors, 16'-7" each; antenna element, 15'-6" each; reflector phasing section 8'-1 1/2"; radiator matching stub 8'-0"; distance between radiators and reflectors (lambda/4) 8'-2 1/2".

good transmitter with real power behind it and that no matter how well our beam is constructed and tuned, it is not going to give us the earth on a silver platter if we insist on using a couple of watts. On the other hand, it is surprising to watch the color change from white through rose to crimson in the cheeks of some of the California Kilowatters when the hundred-watter around the corner makes his rotary beam put them to shame on the income and the outgo.

The second reason why many beams perform fewer miracles than is expected from them is the slipshod manner in which the mechanical details are executed. "Executed" is just about the word for it, by the way.

So much has been written about the various types of beams and the results which have been obtained with them that there is little use in reviewing that subject here. Rather, we shall tell how some of the mechanical details have been worked out and indicate how they may be duplicated with but little expense and moderate ability in the handling of some of the simpler carpenter's tools.

The rotary beam shown in the photograph has been in use at W2AZ since the fourth of July. That station is operated with about eight hundred

watts input most of the time, but it can be run up to a kilowatt. Before the little rotary was put up, an attempt was made to cover the world by using three full-wave "8JK" beams, suitably oriented, and in the clear. These three antennas were eighty-five feet high. Never could the full power be pushed into one of them without having plenty of radiation from the other two. The little beam was put on top of a sixty-foot pole and since it was put in operation every contact that could be had with any of the others also could be made with the little one. Tests have been made, of course, with the other units both up and down. Full mechanical details of this beam, its matching stub and transmission line are given in Fig. 1. It is bi-directional, and for certain territories we believe it would be better to use a close-spaced half-wave uni-directional affair such as is shown in Fig. 2. But we are not considering the merits of any particular type of array; you can do as you please about that. Some serious consideration and more than a little experimental work has resulted in the construction of a good supporting structure, which may be used with almost any sort of array you may desire to use for either ten- or twenty-meter operation.

The job which W2AZ did in building his framework was so good and substantial that we decided that all our worries were over and we duplicated it, hook, line and sinker. We not only got a shock when the lumber and bolts set us back a few cents over five dollars, but our misery was practically complete when we found that the wooden structure, without the insulators or the antenna elements, weighed sixty-four pounds. We don't have all the room in the world, nor do we have a telephone pole. A three-by-three, poked in a corner with a chimney, is just about all we can get away with. So we had to do the job over again, making the changes shown in Fig. 3. The unit which resulted suits our situation very nicely. It cost very much less, weighs only twenty-eight pounds all assembled, and is rugged enough to be perfectly safe. In fact, with the center anchored, we have actually sat on all four of the outside corners, one

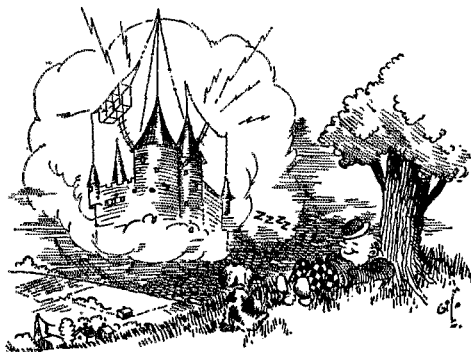

at a time, without being able to bend the structure more than a fraction of an inch.

The finished unit is shown in another photograph. We stuck to the same form of center construction, as well as to the use of 2" by 2" oak main supporting members. Though we have not actually tried it, we are convinced that these could be reduced to 1" x 2", mounted edgewise, further cutting the weight without weakening the structure.

The light-weight final assembly is believed to be a better all-around job, so we will outline a few pointers in connection with its construction, in the hope that some of the time it took us to do the work will be saved those who may wish to copy it. It should be remembered that we are not advocating any particular type of beam, but are suggesting a particular type of framework, which will be found useful in connection with the making of almost any type of beam which the supporting structure can be made to hold. We illustrate but a few, just to give an idea of the versatility of the wooden framework and some new corrugated, copper-plated telescopic steel elements, which have just been developed for this sort of work.⁶

Getting right down to brass tacks, the following list of material is necessary for our own version of the framework which W2AZ built:

- 2 pieces of $\frac{3}{4}$ " plywood, 12" x 12". These should be perfectly square and are used together to form "A."
- 2 pieces of 2" x 2" x 36" oak, main supporting members ("C"), free from knots.
- 2 lengths of redwood, cedar or white pine, suitably finished and free from knots, 16' x 3" by 1 $\frac{3}{8}$ ".
- 4 square head, 5/16" x 4" bolts, used to attach "A" to "B."
- 4 $\frac{1}{4}$ " x 5" square-head bolts, used to join "C," "D" and "E" together, in the center.
- 4 $\frac{1}{4}$ " x 3" square-head bolts, used for joining the outside extremities of "E," to provide the bowing.
- 2 $\frac{1}{4}$ " x $\frac{3}{4}$ " machine bolts, with suitable washers and nuts, used to join the centers of the units marked "F."
- 12 $\frac{1}{4}$ " x 4" square-head bolts, used for joining all the other sections together.

All bolts should have a washer on each side. None of them should be taken up all the way before all the rest of the bolts have been put in place, and they should be taken up a little at a time and in regular rotation.

If the entire platform is measured properly, the hole centers on the units marked "F" of the W2DKJ assembly will measure 5 feet, 1 $\frac{3}{4}$ inches apart.

(Continued on page 118)

⁶ Made by Premax Products, Niagara Falls, N. Y., and to be placed on the amateur market in the near future.

What, No Meters?

Pilot Bulbs as D.C. and R.F. Current Indicators

By Fred Sutter,* W8QBW-QDK

WHEN a fellow figures out a little rig, say 25 to 50 watts output, and discovers that the bulk of the cost is due to plate and antenna meters he is naturally somewhat perturbed. He thinks if only those meter dollars could be spent on the rig itself or on the antenna—or better still, remain on deposit in the good old Lisle Thread National Bank! Can this be done, he asks, and the reply is "Indubitably!" Instead of spending eight or ten dollars on meters use *pilot bulbs*.

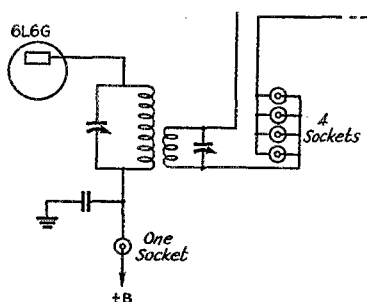

FIG. 1—THE PILOT-BULB INDICATORS WITH THE QSL-FORTY

The number of sockets in the antenna lead will depend on the number of bulbs needed to carry the current in the feeder. Only one socket is needed for a plate-current indicator.

From your supply house order the following:

- 1 box of G.E. Mazda Pilot Bulbs (10) as follows:
- 2 Type No. 40 6.3-volt, 150 ma. Tan Bead
- 3 Type No. 46 6.3-volt, 250 ma. Blue Bead
- 5 Type No. 41 2.5-volt, 500 ma. White Bead
- 6 Sockets for same, either ARH, Y-38 (2 lug) or Yaxley No. 317 H.

The cost of all this will be 90 cents. If you buy the bulbs in less than 10 lots they cost about 10 cents each so you may as well get the box of 10 for 54 cents. You may not need the No. 40, but in any event you should put one of these in series with your crystal (between the crystal and the ground) to be sure how you stand on r.f. crystal current. You won't need all the others, but it is nice to have some spares.

CONSTRUCTION

Mount a socket on the chassis (insulated from

*1000 Kensington Road, Grosse Pointe, Mich.

same, of course) and put in a No. 41 bulb. Your plate current probably won't light this, and after satisfying yourself on this point replace the No. 41 with a No. 46. If your plate current is from 100 to 200 milliamperes the No. 46 will light up from yellow to bright white. Now for the antenna current, which after all is the meat in the coconut. Put your sockets in parallel, and with No. 41 bulbs in these you can handle two amperes of antenna current. If your antenna current is much lower than this take out one bulb, or two, or maybe use only one. If the antenna current is very low, because of location of current nodes, you may even use a No. 46, but this is not likely.

TUNING

Tune plate and antenna so that the antenna bulbs burn brightest while the plate bulb burns dimmest. This gives you maximum antenna current with minimum plate current. There is only one thing that may require watching. When the current is only about half the rated bulb full-load current, the filament will rather sluggishly come up to visibility instead of snapping into brilliance. You are then apt to tune past resonance before the filament has time to light up, especially if the tuning is a little critical. You should therefore "sneak up" to the resonance setting and once the filament heating is visible it is simplicity itself to tune on the nose. Or, a lower-current bulb which will flash up as resonance is passed through may be inserted in the socket and then later replaced by a higher-current bulb. More accurate tuning is possible with a bulb which glows bright yellow instead of white, on account of the great change in brilliancy with even slight tuning adjustments. The eye is very sensitive to these light changes. Anyhow, once you have found out where you are all is smooth sailing. If your antenna system is such that there is no current at the point of measurement then the bulbs won't show anything, but neither will a meter.

Of course you know that the indicated antenna current value may be greater or

less depending on the location of current nodes on your antenna system. And you also know that the object of tuning is to push all the juice into the antenna that the transmitter is capable of supplying regardless of the fact that the indicator shows a quarter of an ampere or an ampere

An economy stunt for the low-power man. The variety of low-current bulbs now available makes a better job possible than was the case with the old flashlight bulbs. Here are some pointers on using them.—EDITOR.

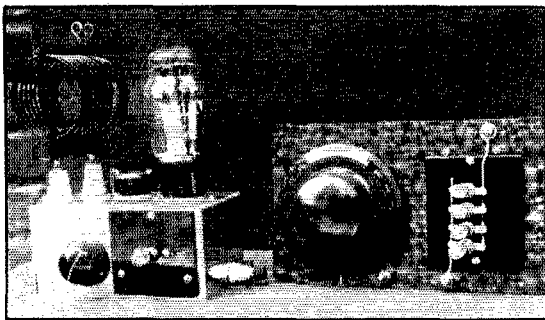

PILOT-BULB EQUIPPED QSL-FORTY AND ITS ANTENNA TUNER

and a half. Whatever it is, you want tops and when the antenna bulbs burn brightest you have it.

When you change bands, which will alter the location of the current nodes, start in with the four 41's and proceed as before. Once you have determined your data no further tentative trials are necessary; just stick in the proper bulbs and tune up. Any unnecessary sockets can be cut out when you find what you require.

The antenna here at W8QBW is an 80-meter half-wave Zepp, 130 feet long, with feeders about 55 feet long; the following is the data:

Transmitter, "QSL-Forty"	Plate bulb No. 46
On 80 meters	Antenna bulbs—3 No. 41's
On 40 meters	Antenna bulbs—1 No. 41
On 20 meters	Antenna bulbs—1 No. 41

The photograph shows a "QSL-Forty" (with a 20-meter coil), the plate meter opening being closed by a bit of bakelite on which is mounted the socket for the plate bulb, a No. 46. The antenna condenser panel is also shown with the r.f. antenna meter opening similarly closed, and an array of four sockets in parallel mounted thereon. I have mounted these in front so as to show the construction more clearly, but to make a slightly job the sockets should be mounted in the rear and only the shells extend through the panel. I cannot prophesy just what you will need with your rig and antenna, but what has been said above should make it easy for you to determine this. A cautionary word: Be sure that your bulb array is in the antenna feeder and *not* in the antenna tank circuit, which in some cases may show a current of 4 or 5 amperes even with low power. It is conducive to peace of mind to know that while a burned out or damaged meter means money, a burned out pilot bulb means only a nickel.

POWER LOSS

It may be pointed out that bulbs consume power. Well, so do meters, for you can't get some-

thing for nothing, the main difference being that with bulbs you can see the watts while with meters you cannot. The No. 46 bulb at average operating point takes about one watt or slightly less and the No. 41 about the same. Plate d.c. milliammeters consume very little power—a hundredth of a watt or so. Antenna meters consume more, depending on the range. About a half watt to one watt would be a fair average.

Midwest Division Convention

Omaha, Neb., October 29th-30th

THE Hotel Paxton awaits you HAMS. Just mark your calendar and plan to come to this unique convention. The special convention committee under the general chairmanship of W. H. (Bill) Graham is putting its efforts in preparing a program that will long be remembered by those who attend. This is a final appeal to all amateurs in the Midwest Division to attend the affair. Just sit down and drop a note to "Bill" Graham, Suite 212, Hotel Paxton, Omaha, Neb., and tell him you will be there.

Silent Keys

It is with deep regret that we record the passing of these amateurs:

- Harry E. Anderson, W9CQB, Sioux City, Iowa
- Howard C. Barton, W8IH, Buffalo, N. Y.
- Ralph L. Brown, Jr., W5CYC, Hollandale, Miss.
- W. Collins, VK2AEI, Wagga Wagga, N.S.W., Aust.
- Wilbur H. Crumbaker, Sr., W9TAD, Elmwood, Ill.
- Walter A. Deane, W1SB, Quincy, Mass.
- James A. Fink, W9UMO, Minneapolis, Minn.
- Owen F. Foin, W6NTS, Fresno, Calif.
- Frank D. Foster, W5GQ, Meridian, Miss.
- Lt. Cmdr. Frank M. Hawks, W11JI, Redding, Conn.
- Luis A. Mailhe, CX1FO, Real de San Carlos, Colonia, Uruguay
- Walter Schultze, ex-W9LAI, Chicago, Ill.
- J. Howard Shaw, Jr., W1GGS, Portland, Me.
- Leonard D. Sumner, W4ACI, Hendersonville, N. C.
- James R. Weston, W8AIN, River Rouge, Mich.
- George P. Wiggins, W6JJA, Alhambra, Calif.

● ARMY-AMATEUR RADIO SYSTEM ACTIVITIES ●

IN maintaining a large operating organization such as the Army Amateur Radio System, many problems are encountered. As in other Corps Areas, the Sixth Corps Area has its own particular place in the system and its own special problems, besides those that are common to the whole system.

Not the least among these problems is the great need for a trained group of operators and their stations in those sections of the Corps Area most subject to emergencies, such as floods and storms. The need for more and better operators in the nets already in operation is also felt. More members of good caliber are especially desirable in order to increase interest in the work and maintain the reliable relay and delivery of traffic within the Corps Area. Prospective members invariably ask, "What interesting activities does membership in the A.A.R.S. provide for the average amateur?" Our third problem then, is to provide interesting and constructive activity for our members.

The Sixth Corps Area consists of the three states, Illinois, Michigan and Wisconsin. Colonel J. C. Moore is the Signal Officer in charge and Major A. V. Eliot acts as Liaison Officer. Headquarters is located in the New Post Office Building, Chicago and Headquarters station W9ANR/WLT is maintained at the Army Supply Depot in Chicago.

The big Ohio River Valley flood of 1937 proved that we lacked an adequate number of stations in that area. An investigation by Major Eliot disclosed that the reason for this was that nearly all of the amateurs in that area were 'phone men. One of our members, Sgt. George Freer, W9MWU, with the help of two or three others, then organized an 1887-kc. 'phone net for the Corps Area. A system of procedure, similar to that used by c.w. members but adapted to 'phone net use, was made up. By concentrating on southern Illinois, Freer was able to build up the Illinois section of the 1887-kc. 'phone net to 38 members in a half year, the greater number of which are located in vital emergency areas of the state. Later a 3915-kc. 'phone net was organized to further aid our coverage.

To increase interest and flexibility of operation for the c.w. stations, an unusual system of operation and cooperation was devised. As in other Corps Areas, we have all the stations in each state operating on a single state net frequency, with one exception—a local net in Chicago using 1765 kc. We have improved upon that idea a great deal, however. Through cooperation of the SCM for Illinois and the Radio Aide, an agreement was made between the A.R.R.L. Traffic Net sta-

tions and the A.A.R.S. stations for the joint use of the A.A.R.S. State Net frequency. Due to the mutual interests of both groups, it was a distinct benefit to both. The scattered traffic men came together and, with a large group from the A.A.R.S. State Net, formed a state-wide A.R.R.L. Traffic Net. Many of them then became interested in the A.A.R.S. work they heard on that frequency and became members of the A.A.R.S. By setting certain periods for each group to operate, many more stations were able to use the net frequency each day, and interference was kept at a minimum. Many amateurs not connected with either the traffic or A.A.R.S. organizations were impressed with the efficient system we had, and the connections it offered, and joined the nets. Michigan and Wisconsin took up the idea and we now have three state net frequencies in this Corps Area used by cooperating A.R.R.L.-A.A.R.S. nets, 3663 and 3775 kc. for Michigan and Wisconsin, and 3765 kc. in Illinois. The bulk of the traffic is moved during the A.R.R.L. Traffic Net periods, which leaves the A.A.R.S. period free for various forms of drill and instruction work. As an emergency feature this system offers a much faster means of getting organized in time of need. The joint use and the large number of stations means that the frequency is being covered almost continuously by some state net station from 5:00 P.M. to midnight or even later. Stations come in and drop out of the net all through the evening so that in a short while a sizable net could be formed covering most of the state. All these features tend to attract the better class of operators to the A.A.R.S. Keeping them interested after they become a part of the system is the problem that we need to place most emphasis on now.

The interest of the average amateur seems to run in cycles. First he gets very interested in one thing, then he changes to another. When he becomes interested in handling traffic and in emergency work, he has found something useful to do. But if he has to sit around and twiddle his thumbs all the time while the net clears all the traffic he soon will tire of it and lose his interest in the net. To prevent this, all nets should be made as interesting as possible. The traffic net arranges its callup and operations so that the operator will know whether he has any traffic coming to him or whether he can leave the net to make better use of his time. The A.A.R.S. cuts traffic to a minimum and concentrates on drill work and various problems, such as finding unknown stations, moving the entire net to other frequencies and reestablishing the net.

(Continued on page 122)

How Would You Do It?

Crystal Oscillator Keying Systems

RESPONSE to Problem No. 20 shows evidence of plenty of interest in the subject of clean keying of crystal oscillators free from chirps. It must be said, however, that the number of opinions on the best keying system almost equals the number of contestants! Nevertheless, there seems

popular place for the key in the simpler arrangements is between the cathode circuit and ground as shown in Fig. 1. This is reported by many to be a very satisfactory arrangement from consideration of both chirps and key clicks. At A is shown the alterations recommended with the Tri-tet circuit. Fig. 1B shows the recommended connection for the key in the grid-plate type oscillator. Most of the contestants recommend the use of a separate plate-voltage supply for the oscillator.

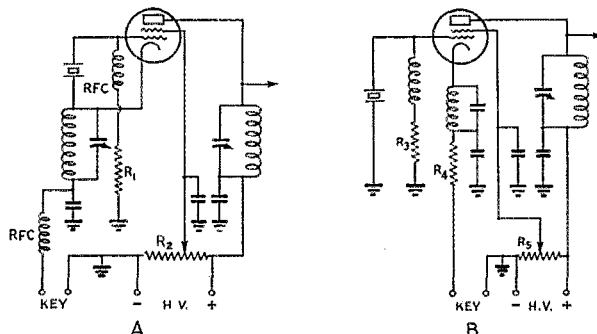

FIG. 1. A—CATHODE KEYING FOR TRI-TET OSCILLATOR

Typical values for 6L6: R_1 —50,000 ohms; R_2 —20,000 ohms. B—Cathode keying for grid-plate oscillator. Typical values for 6L6: R_3 —50,000 ohms; R_4 —400 ohms; R_5 —20,000 ohms.

to be general agreement on some points. The axis of crystal cut seems to have little bearing on its performance in keyed oscillator circuits. "Active" specimens, however, appear to operate with less tendency towards chirp than those which deliver less output.

No marked preference for tubes was expressed except that W80MM claims that the RCA Type 1610, a little-known tube in amateur circles, similar to the Type 47, is superior to other types. W2ESO's experience shows that the better screened tubes, such as the 802, RK25, 807 and 2A5, do not key as well as the beam types or triodes with less screening, or no screening at all, unless they are provided with the right amount of feed-back coupling. The majority of diagrams submitted show the 6L6 as the oscillator, quite probably a result of the natural popularity of the tube rather than any particular merits this particular type may possess in respect to keying.

It has been the experience of most of the contestants that the use of a voltage divider instead of a simple series resistor for the screen helps materially in eliminating chirps. The most

Of the less conventional circuits those shown in Fig. 2 are interesting. The one shown at A is by W6EPM. "From the circuit diagram it will be noticed that plate voltage is applied continuously to the tube and that the key is in series with the screen. The advantage of this is that the voltage across the key is not very high and that the current to be handled by the key is of the order of only a few milliamperes. Under the conditions of the circuit, the plate circuit may draw one-half to two milliamperes with the key open. This tends to keep the crystal oscillating at low amplitude. When the key is closed, the tube draws normal plate current. Even with only fair crystals, the oscillator will key perfectly and not chirp. In the case of a poor crystal, excitation may be increased by short pieces of push-back wire from the plate and from the control grid running parallel for about one and one-half inches, spaced about one-eighth inch.

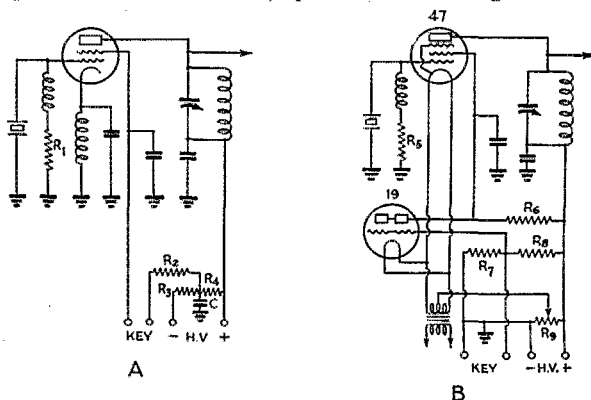

FIG. 2—TWO SYSTEMS FOR SCREEN KEYING OF TETRODES OR PENTODES

A—For 89 or 802: R_1 —7500 ohms; R_2 —5000 ohms; R_3 —30,000 ohms, 20 watts; R_4 —40,000 ohms, 20 watts. B— R_5 —10,000 ohms; R_6 —75,000 ohms; R_7 —10,000 ohms; R_8 —100,000 ohms; R_9 —Usual plate supply bleeder.

Problem No. 22

OUR Hero has three different antenna systems now and is planning the addition of one or two more. Some of these employ a 70-ohm transmission line, others a 600-ohm line while one or more may have a tuned line for multi-band operation. He has one antenna relay for switching from transmitter to receiver. He is now faced with the problem of devising an antenna changing system by which, with a minimum of switches and tuning gear, he may change rapidly from one antenna system to another maintaining constant load on the transmitter for a given frequency and also proper coupling to his receiver. He wants to be able to control all switching operations from the operating position.

This is not often necessary, but it regulates the current with key open and consequently the strength of oscillation. If too much capacity is used, it will be possible to hear an S7 to 8 signal in the receiver at the crystal frequency. Either 802's or 89's are recommended. The Type 802 is much the better tube; the local signal is difficult to eliminate with the 89. The 6L6 is not recommended."—W6EPM.

This arrangement seems possible of providing excellent keying characteristics, although the presence of the local signal would be objectionable to those desiring break-in operation on the crystal frequency.

Another screen-circuit keying scheme is shown

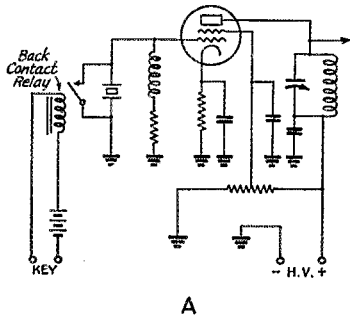

FIG. 3—CRYSTAL KEYING CIRCUITS

in Fig. 2B. This particular combination is described by W9QOA. G2IS suggested a very similar arrangement employing a relay at the key position.

"The keying circuit shown in Fig. 2B was built into a new transmitter at W9QOA and has given very satisfactory results. Keying is reported to be very smooth and no chirp has been noticed when the signal has been monitored locally. The circuit

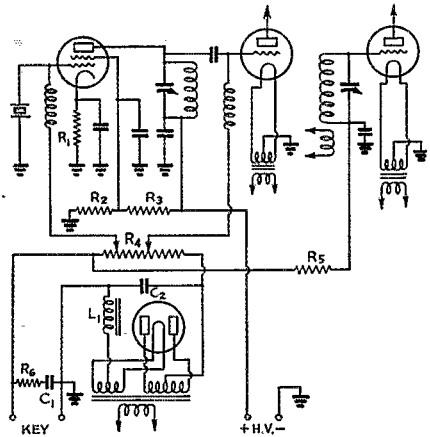

FIG. 4—BLOCKED-GRID KEYING SYSTEMS

R_1, R_2, R_3 —Usual values; R_4 —20,000 ohms, 50 watts; R_5 —Final stage grid leak.

was designed to allow keying of the oscillator without the use of a separate filament supply, but it has been found very satisfactory in other ways also.

"The basic principle of the circuit has been in use for years, but the writer has never seen it applied in the form shown here. When the key is open, the keying tube acts as a low-resistance shunt across the screen of the oscillator tube because of the positive bias impressed on the keying tube grids through the resistance R_3 . Since the combined resistance of the oscillator screen circuit and the keying tube plate circuit is low compared to R_6 , the voltage between the screen and filament of the oscillator tube is reduced to such a low

value that oscillation cannot be maintained.

"When the key is closed, the positive bias on the grids of the keying tube is removed, thus increasing the plate resistance of the keying tube and causing the oscillator screen voltage to increase to the proper value required for the generation of oscillations. The operation of the keying tube can be improved by applying a negative bias to its grids and to the grid of

the oscillator by tapping the filament return up on R_6 as shown in the diagram. This has the dual effect of increasing the plate resistance of the keying tube when the key is closed and of increasing the plate resistance of the oscillator tube when the key is open, both of which increase the range of control.

"The most suitable tubes for use as keying

(Continued on page 59)

A Compact 100-Watt Transmitter

Six-Band Coverage with Quick Band-Changing

By Thomas Sue Chow,* W6MVK

The author mentions, rather casually, that the transmitter described here was built in preparation for the last Sweepstakes. The rest of the story was left out, either because results speak for themselves, or possibly, because complete contest results had not been published when the article was written. This is the rig with which W6MVK established new Sweepstakes records—first c.w. station to work all sections, and the highest score ever made under the present rules!—EDITOR

IN PLANNING for the last Sweepstakes Contest, it was decided that a complete new transmitter would have to be built to get better results. The requirements for the new outfit were, low cost, multiple band coverage, QSY with minimum retuning, ample excitation with no "trick" circuits, low-cost 'phone operation, and foolproof non-critical adjustments. Much time was spent searching through radio publications for ideas with these goals in mind. The resulting design is the combination of what appeared to be the most suitable circuits.

TRANSMITTER

The transmitter is a small one using three tubes and four stages—6A6 oscillator-doubler, 6L6G buffer-doubler, and RK-20 output. It is mounted completely on a 10" × 17" × 3" steel chassis except for a bias battery and the high-voltage supply for the final.

The three most used bands, 40, 20 and 10 meters, can be switched on within five to ten seconds with full (100 watts) output, without disturbing the final coil or antenna coupling. The adjacent

* 701 8th Street, Modesto, California.

bands can be switched on within three to five seconds. The circuits are broad enough to QSY from 50 to 150 kc. without retuning the final stage. This in itself is a distinct advantage. Other advantages of this exciter-transmitter are that it is compact (it is only eight inches high), it can be built at low cost, and it will cover as many bands as the majority of band-switching receivers with practically the same speed. With a 160- and a 40-meter crystal, six bands can be covered. The output on five meters is reduced because the final is a doubler.

FINAL

The RK-20 was selected for the output tube because it is easy to drive, needs no neutralizing, doubles well, and can be easily suppressor-grid modulated. The tube is placed horizontally to reduce the overall height, with the plate edges down to minimize the effects of filament sag.

A single sheet of aluminum, bent as shown in the photograph, serves a two-fold purpose by acting as a coil shield, shielding the final plate output circuit from the input, and as a base for mounting the RK-20. An old i.f. can trimmed

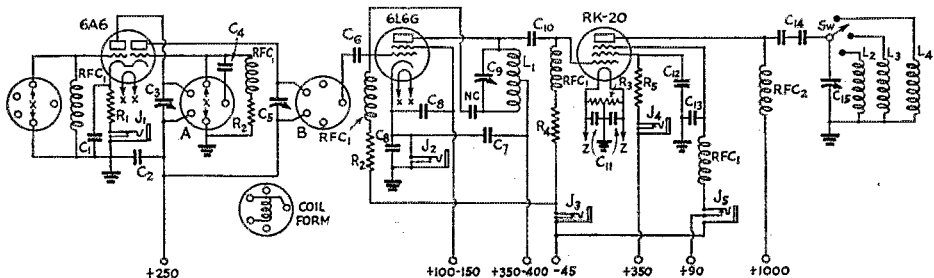

FIG. 1—R. F. SECTION DIAGRAM

- C₁—0.01- μ fd. mica.
- C₂—0.002- μ fd. mica.
- C₃—100- μ fd. midget variable.
- C₄—50- μ fd. mica.
- C₅—100- μ fd. midget variable.
- C₆—50-100- μ fd. mica.
- C₇, C₈—0.002- μ fd. mica.
- C₉—200- μ fd. variable (two 100's in parallel).
- C₁₀—250- μ fd. mica.

- C₁₁—0.002- μ fd. mica.
- C₁₂—0.005- μ fd. mica.
- C₁₃—0.002- μ fd. mica.
- C₁₄—0.005- μ fd. tubular oil-filled (two in series).
- C₁₅—150- μ fd. transmitting condenser (0.077" spacing).
- R₁—400 ohms, 10-watt.
- R₂—20,000 ohms, 1-watt.
- R₃—75 ohms, center-tapped.
- R₄—6000 ohms, 2-watt.

- R₅—2000 ohms, 10-watt.
 - RFC₁—2.5-mh. r.f. choke.
 - RFC₂—2.1-mh. r.f. choke.
 - J₁, J₂, J₃, J₄—Single open-circuit jacks.
 - J₅—Closed circuit jack (for suppressor modulation).
 - Sw—3-point transmitting band-switch (ohmite).
- See Table 1 for data on coils.

down to the height of the lower edge of the pentode's internal shield, serves as a base shield, and clears the glass about a quarter of an inch.

The band switch is controlled from the front panel by a flexible insulated shaft, which had not been installed at the time the photo was taken. The shaft is mounted on a square of bakelite, since the switch itself is insulated for only 600 volts. The lugs for mounting coils on the switch were made more firm by scraping the lug up to the ceramic and covering it with a heavy layer of solder.

In the plate circuit of the RK-20, the tuning condenser is left permanently connected to the plate for all bands and only the individual inductances for various bands are changed. This saves the cost of separate tuning condensers for each coil, although the condenser used will require retuning when changing bands. When the RK-20 is shielded sufficiently, no neutralizing is necessary. A single-section condenser is used, with the lower of "cold" ends of all the coils tied together and to the condenser rotor, and the plate ends are switched to change the inductances.

Losses on 10 and 20 meters were reduced by using air-wound coils and soldering them directly to the lugs of the band switch. This arrangement not only eliminates several standoff insulators, but also provides short leads and low-resistance connections. The third contact on the switch is wired to an isolantite socket in order that the low-frequency final coils can be handled there with plug-in coil forms. These ribbed bakelite forms are handy, inexpensive, durable, easy to wind, and have little loss at low frequencies.

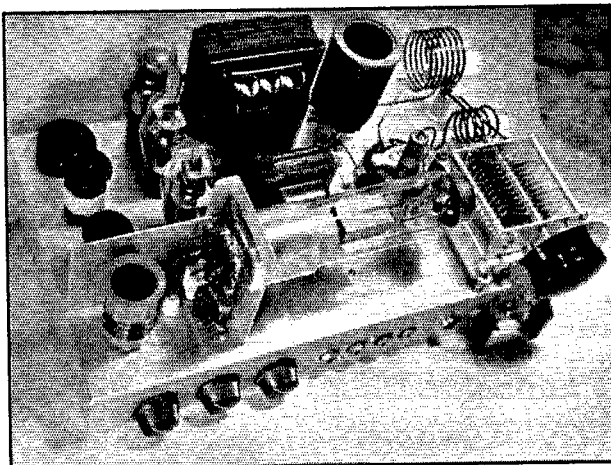

W6MVK'S QUICK BAND-CHANGE TRANSMITTER-EXCITER

Except for the RK-20 plate supply and a bias battery, the unit is a complete transmitter. Coil switching covers three bands in the final stage, with a plug-in position for additional bands.

DRIVER

The small beam power tube used as a driver gives excess excitation both as a buffer and as a doubler. The use of a 200- μ fd. condenser makes just one coil necessary to tune the plate circuit to resonance on two adjacent bands. The 6L6G was selected over the transmitting type because of its low cost, in spite of the fact that it had to be neutralized. Neutralizing is not expensive because of the low r.f. voltage encountered, and can be accomplished very easily by soldering a heavy piece of No. 10 wire about an inch long to the plate condenser, wrapping about six turns of heavily insulated wire around this bus, and by varying the number of turns of the bus wire trombone style. The same battery which supplies fixed bias to the final serves a double purpose by also supplying sufficient negative voltage to cut off the 6L6G, thus allowing complete break-in and preventing damage to the tubes in case of excitation failure. The plate of the driver need not be retuned in QSY-ing across the entire band because of the use of a large coupling condenser to the final grid.

OSCILLATOR-DOUBLER

The 6A6 crystal oscillator-doubler¹ can be changed from oscillator to oscillator-doubler without use of switches. Low-priced bakelite sockets for the two crystal positions were reamed out slightly with a countersink in order to accommodate both types of prongs on most crystal holders. These

¹—W6FKZ, *Radio*, June, 1937.

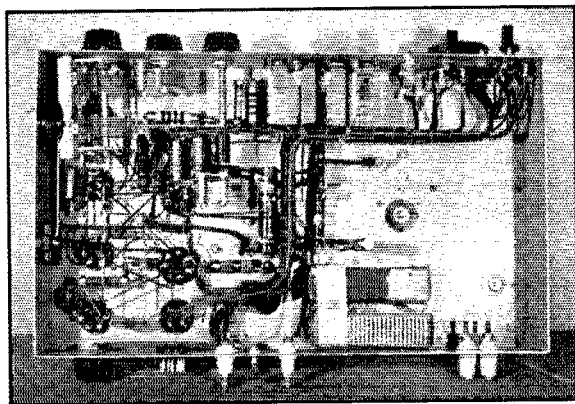

BELOW-CHASSIS VIEW

The flexible shaft and coupling controlling the band-switch was not installed when this photograph was taken.

enlarged holes enable one to change crystals more quickly by acting as guides to the proper insertion points. From 200 to 250 volts on the 6A6 and about 350 volts on the 6L6G are all that are necessary to give sufficient excitation. This was an important consideration, since the

volt winding gives about 7.7 volts to the RK-20 filament. This voltage can be found at a point $1\frac{1}{4}$ volts from one end of the 6.3-volt winding, as shown in Fig. 2. The full $2\frac{1}{2}$ -volt winding is used to help relieve the drain of the RK-20 filament on the regular 6.3-volt windings. The volt-

age drop to the RK-20 socket was reduced by the use of No. 12 wire insulated with spaghetti.

The need of immediate replacement of filter condensers is done away with by grounding them through a short piece of fuse wire. As a general rule, only one section of the filter blows out at one

time; under this arrangement, the blown section automatically removes itself from the circuit.

The operation, while obviously depending on the frequency of the crystal used, is straightforward and needs no detailed comment. The quickest adjacent-band switching can be done by hitting the lowest frequency desired on the coil which resonates on the high-capacity side of the driver condenser, C_2 , using the driver tube as a straight amplifier. To shift to the next band, it is only necessary to double in the driver by shifting C_2 to the low-capacity end and switch the coil of the final to the same frequency. If separate antenna tuners are linked to each final coil, no adjustment is necessary once the coupling is correct. No retuning would be required to QSY across the entire band except in the plate tank of the final. The necessity for even this tuning can be minimized by reducing the plate voltage to 1000 volts and using tight antenna coupling so that the RK-20 is heavily loaded (to about 100 ma.). Retuning will be necessary every 200 kc. on 20 meters and 125 kc. on 40 meters.

For 56-Mc. work, the final acts as a doubler and a small outboard tank circuit can be slipped on in place of the regular plate clip. Reduced plate voltage, approximately 600 to 800 volts, is used. On ten meters, the plate showed no color with the key down, although the input was 100 ma. at 1350 volts. The driver plate condenser was detuned to reduce the final grid current to from 5 to 7 ma. The RK-20 screen draws 30 ma. at 325 volts, with 90 volts positive on the suppressor grid. No attention need be paid to the remaining stages so long as sufficient excitation is available. A 100-watt lamp measures full brilliancy at 10 meters, with slightly greater output on lower frequencies.

If no suppressor-grid modulated 'phone is desired, a RK-47 or 814 will give higher output. About 150 watts can be obtained with proper changes. Connection for suppressor-grid modulation is made by plugging into J_5 , shown in Fig. 1. This automatically puts a negative bias of 45 volts on the suppressor, and disconnects the positive 90 volts used for c.w. operation.

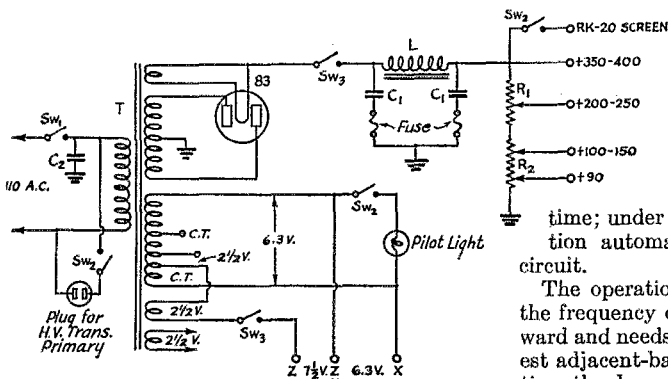

FIG. 2—LOW-VOLTAGE POWER SUPPLY DIAGRAM

This unit is on the same base as the transmitter, but is shown separately to avoid complicating the diagram.

- L—15-henry, 100-ma. choke.
- C_1 —8- μ fd., 525-volt electrolytic.
- C_2 —0.1- μ fd. 400-volt paper.
- R_1 —5000-ohm, 25-watt, with slider.
- R_2 —25,000-ohm, 25-watt, with sliders.
- Sw_1 —S.p.s.t.
- Sw_2 —3-p.s.t.
- Sw_3 —D.p.s.t.
- T—Power transformer; 360 v. d.c. at 125 ma., with 6.3-v. tapped, and 2.5-volt windings (Jefferson 463-361)

low plate voltage permits the use of inexpensive power-supply parts.

POWER SUPPLY

The transformer used has a heavy 6.3-volt winding, which when placed in series with a $2\frac{1}{2}$ -

TABLE I—COIL DATA

6A6 Oscillator-Doubler Coils:

- 1.75 Mc.: 59 turns No. 22 d.c.c. close-wound.
- 3.5 Mc.: 31 turns No. 22 d.c.c. close-wound.
- 7 Mc.: 14 turns No. 18 d.c.c. close-wound.
- 14 Mc.: 8 turns No. 18 d.c.c. space-wound to $1\frac{1}{4}$ in.
- All wound on $1\frac{1}{4}$ -inch coil forms except 1.75 Mc. coil, which is on $1\frac{1}{2}$ -inch form.

6L6G Plate Coils:

- 1.75—4 Mc.: 42 turns No. 22 d.c.c. close-wound.
- 3.5—7.3 Mc.: 20 turns No. 22 d.c.c. close-wound.
- 7—14.4 Mc.: 10 turns No. 18 pushback, space-wound to $1\frac{1}{4}$ in.
- 14—30 Mc.: 4 turns No. 10, air wound 1" dia., spaced wire dia.
- All except 14-30 Mc. coil wound on $1\frac{1}{4}$ -inch forms.

RK-20 Plate Coils:

- 1.75 Mc.: 44 turns No. 16 enamelled, close-wound.
- 3.5 Mc.: 24 turns No. 14 enamelled, space-wound to 3 in.
- 7 Mc.: 12 turns No. 14 enamelled, space-wound wire diameter.
- 14 Mc.: 7 turns No. 14 enamelled, $1\frac{1}{2}$ in. dia. $1\frac{1}{2}$ in. long.
- 28 Mc.: 4 turns No. 10 enamelled, 1 in. dia. $1\frac{1}{4}$ in. long.
- All wound on $2\frac{1}{4}$ -in. ribbed forms except the 14 and 28 Mc. coils, which are air-wound. The 14-Mc. coil is on celluloid strips; the 28-Mc. coil self-supporting.

Low Z for Linearity

A 35-Watt Low Distortion Speech Amplifier with Push-Pull-Parallel Triode Output

By M. A. Brown,* W6ABF and J. N. A. Hawkins,** W6AAR

WHILE it has been widely known that good driver regulation is desirable for a low-distortion Class-B modulator, the authors found recently, with the aid of a borrowed RCA distortion-measuring set, that 6L6's with normal amounts of feed-back are far from ideal as Class-B drivers. After spending considerable time and effort in trying to get the bugs out of the 25 db of feed-back which was found to be necessary with 6L6 drivers, it was decided to try out some of the newer low-mu Class-A tubes which have appeared recently. It was felt that a higher net gain with fewer tubes might be realized with the lower mu triodes, since less feed-back is necessary with those tubes.

Low-mu triodes are inherently non-uniform. Past experience with practically all of the older types showed that the RCA 45 and the Western

*328 W. Valley View, Altadena, Calif.
**2807 8th Ave., Los Angeles, Calif.

Electric 205D were the only ones available whose characteristics matched closely enough for the theoretical benefits of push-pull operation actually to be obtained in practice. The types WE-300A and the 2A3 were particularly bad offenders, so far as unbalance is concerned. However, tests with many of the newer types of pentodes, tetrodes and triodes, all operated as triodes, showed that the new 6A5G had interesting possibilities. Because of its indirectly heated cathode, trouble from tired and leaning filaments is avoided, and a more rigid element support is used than in most other available tubes.

A haywire breadboard setup showed that the 6A5G was just about what was wanted, so a complete speech channel was built up, ending up in four of them in push-pull parallel. After chasing out the bugs that breed in any new speech channel, the final result represented a marked improvement over the 6L6 channel used previously.

In laying out the voltage amplifier to feed the push-pull-parallel output stage it was decided to provide a high-gain input for low-level high-impedance microphones and a medium-gain high-impedance input for phonograph or telephone lines. Grief with pentode audio amplifiers made the use of triodes desirable, and the phase distortion caused by conventional resistance-coupled phase inverters caused us to go to a transformer-coupled phase inverter.

The circuit was originally laid out with about 6 to 10 db of inverse feed-back in mind but it was decided to do as good a job as possible with the amplifier before the feed-back was applied. It should be pointed out that no amount of feed-back will entirely eliminate distortion and noise—all it can do is reduce it—so obviously the less noise and distortion you start with, the less work the feed-back has to do.

The diagram shows 10 db of feed-back, but the single-pole double-throw switch in the cathode of the 6F6G cuts it out when desired and raises the net gain by the amount of the feed-back, or 10 db. With feed-back the distortion is slightly under 2 per cent at 35 watts output and is under 0.5 per cent at 25 watts output. Without feed-back the distortion at 35 watts output is slightly less than 5 per cent, and is under



THIS COMPACT AMPLIFIER IS CAPABLE OF AN OUTPUT OF 35 WATTS WITH LESS THAN 2% DISTORTION

Well suited for driving a high-power Class-B modulator or for public address work, it utilizes four low plate-resistance triodes in the output stage. Microphone and phonograph inputs are provided. A cover fits over the top to conceal the tubes and other components.

1.5 per cent at 25 watts output. It is felt that, in general, the feed-back branch can be left out without any noticeable impairment of speech quality. The frequency response is flat to 2 db from 40 to 8000 cycles without feed-back and there is no need to worry about anything outside of this range with present mikes and speakers. As a matter of fact, it is generally desirable, in a ham rig, to kill most of the highs with the tone control, to avoid adjacent channel QRM.

Without feed-back the plate-to-plate load for maximum undistorted output is 1500 ohms. As a Class-B driver the optimum plate-to-plate load is 2750 ohms. The use of feed-back cuts these loads way down, but extremely low load impedances make the Class-B input transformer design difficult.

For driving zero-bias Class-B modulators about a 1.25 to 1 step-down in the Class-B input transformer is desirable when working from four 6A5G's. For the medium-mu tubes such as 354's, 150T's and 250TL's, etc., about a 1-to-1.25 step-up works out best. Thus the same transformer would work with any tube combination. The

output transformer shown, and used at present in the amplifier, is a universal type with both low-impedance and high-impedance taps on it, allowing the amplifier to serve for p.a. use when opportunity affords. However, one big advantage of

triode drivers is that they work well with nearly any driver transformer and Class-B tube combination available, with only a slight loss in gain when impedances are not perfectly matched. Thus a cheap Class-B input transformer

gives good results with triodes over a wide range in secondary loads while input transformer design is quite critical when using beam tetrodes as drivers.

The 6A5G's have very high transconductance, and the two 100-ohm grid resistors are desirable to prevent oscillation which sometimes occurs with these tubes. They are not always necessary, but they do no harm and they help hold things down.

Bigger blocking and by-pass condensers could have been used to bring up the low-frequency response, but this is generally unnecessary on speech. It was considered desirable to make the

The authors make out a good case for 6A5G output tubes, and describe a high-gain amplifier with plenty of output for driving a 500-watt Class-B modulator. Good, too, for public-address work.—EDITOR

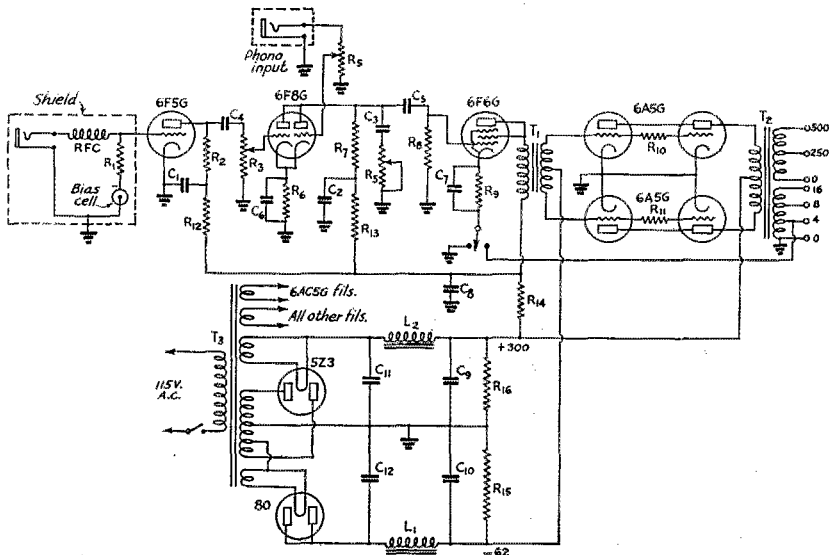

FIG. 1—CIRCUIT DIAGRAM OF THE 35-WATT SPEECH AMPLIFIER

- C₁, C₂, C₃—0.1- μ fd. paper, 600-volt.
- C₄—0.01- μ fd. paper, 600-volt.
- C₅—0.05- μ fd. paper, 600-volt.
- C₆, C₇—50- μ fd., 50-volt electrolytic.
- C₈, C₉, C₁₀—16- μ fd., 450-volt electrolytic.
- C₁₁—8- μ fd., 600-volt.
- C₁₂—8- μ fd., 450-volt electrolytic.
- R₁—5 megohms, 1-watt.
- R₂—150,000 ohms, 1-watt.
- R₃, R₄, R₅—500,000-ohm volume control.

- R₆—3000 ohms, 1-watt.
- R₇—100,000 ohms, 1-watt.
- R₈—500,000 ohms, 1-watt.
- R₉—750 ohms, 10-watt.
- R₁₀, R₁₁—100 ohms, 1/2-watt.
- R₁₂, R₁₃—25,000 ohms, 1-watt.
- R₁₄, R₁₅—5000 ohms, 10-watt.
- R₁₆—50,000 ohms, 25-watt.
- RFC—2.5-mh. r.f. choke.
- T₁—Audio transformer, single plate to push-pull grids, primary to

- carry 6F6G plate current (Hadley 3991A).
- T₂—Output transformer, 1500 ohms to line or speaker, 50-watt (Hadley 3995A).
- T₃—Power transformer, 350 ma. at 300 volts, with bias tap (Hadley 4070A).
- L₁—50-ma. filter choke (Hadley 872).
- L₂—350-ma. filter choke (Hadley 3772A).

input resistance in the high-gain channel 5 megohms for maximum gain and then hold the boominess down with lower values of blocking and by-pass condensers. The maximum gain is 120 db in the high-gain channel and 80 db in the low-gain channel.

The new 6F8G is ideal for electronic-mixer use because it has high plate resistance, which means that the unused half does not unduly load the side being used. Its high- μ also allows it to contribute considerable gain, which is unusual in an electronic-mixer stage.

A 6J5G could have been used in place of the 6F6G to drive the push-pull-parallel stage, but overload tests showed that the 6J5G stage overloaded first (at about 38 watts) so it was replaced with the triode-operated 6F6G, which costs no more. As long as it doesn't cost anything, it is desirable to have every stage "crack up" at about the same point, which gives most usable peak output.

Ordinarily the push-pull-parallel stage draws no grid current, but since the 6F6G can supply some power when and if called on to do so the quality does not suffer materially on speech thereby. It should be noted that while this should be called a 35-watt amplifier for use on music, it will do a fairly good job of lighting up a 75-watt lamp with better than average speech quality. It was used to overmodulate over 150 watts of Class-C r.f. amplifier input with better quality than most push-pull-parallel 6L6 amplifiers.

Normally the output stage operates Class-A and the plate current varies very little so regulation of the plate supply is not a problem. No difficulties have been encountered in building several copies of this amplifier by various local hams so it is believed to be pretty well debugged.

The 5Z3 is working fairly hard but seems to like it so its virtue of cheapness was gladly utilized.

The shielding around the input of the 6F5 and over the whole amplifier is particularly important if the amplifier is to be used around a transmitter. A gain of 120 db is a lot in any league, and is rarer than one might think after reading the catalog!

How Would You Do It?

(Continued from page 58)

tubes are those of the Class-B-amplifier or zero-bias type which are almost cut off at zero bias and which yet draw a large plate current when their grids are biased a few volts positive. A Type 19 tube with the elements in parallel is being used here to key a Type 47 since these tubes happened to be on hand. Improved operation would be obtained, no doubt, if more suitable tubes were used. Almost any combination of tubes could be made to work satisfactorily with resistances R_6 to R_8 of suitable values for the tubes used. The values shown are possibly not optimum since only a limited amount of experimenting has been done with this circuit. However, the values do not appear to be very critical. R_5 is, of course, the usual oscillator leak. R_6 is the screen voltage-dropping resistor. In this case, it forms part of a variable potentiometer consisting of R_6 and the keying tube in series. R_8 is used to limit the current drawn by the grid of the keying tube and also to prevent the key from short-circuiting the power supply. Thus the value of resistance may be quite high since its only purpose is to provide a positive voltage to the grids of the keying tube. R_7 is not essential to the operation of the circuit but is used to limit the voltage across the key. A resistance of about one-tenth the value of R_8 will provide sufficient positive bias for operating the keying tube.

"If the oscillator is not loaded or is loaded lightly, it may continue to oscillate weakly when the key is open. However, when the oscillator is fairly well loaded, it will stop oscillating completely because of the additional damping introduced in the circuit. It may be necessary to experiment a little with the values of R_6 , R_7 and R_8 and the negative bias on the grids in order to obtain clean keying at high speeds, but no trouble has been experienced at ordinary hand keying speeds."—W9QOA.

In the arrangement suggested by G2IS, a double-contact relay was used to shift bias on the grid of the keyer tube from negative to positive. G2IS states that lag introduced by the relay helps to prevent chirps. A Type 45 tube is suggested for

(Continued on page 62)

HE SEZ HE WAS CHIEF OF COMMUNICATIONS IN THESE PARTS — BEFORE HIS ARM WENT GLASSY



56-Mc. DX Tests

WITH 56-Mc. DX via the F_2 layer a good possibility this winter, test schedules have been proposed by E. H. Conklin, W9FM. He suggests (and has so notified British amateurs) that W stations listen from 10:00 to 10:10 A.M. E.S.T. and for alternate ten minute periods until 11 A.M. each Saturday and Sunday during November. DX Stations should, of course, listen during alternate ten minute periods beginning at 10:10.

HINTS and KINKS for the Experimenter



Three-Band Crystal-Controlled Exciter Using One Tube

A SMALL oscillator-doubler combination which gives maximum stable output and frequency flexibility for the tube and parts investment is shown in Fig. 1. Although the system does not contain radically new ideas, it is well recommended by the simple and straightforward circuit employed.

One section of a 6A6 dual-triode tube is used as oscillator for fundamental and second-harmonic output, and the other section is used as a triode non-regenerative doubler. For fundamental or second-harmonic excitation to a succeeding stage, the output of the oscillator alone is used. Only when quadrupling the crystal frequency are both oscillator and doubler operated.

When the plate tank circuit of the oscillator is

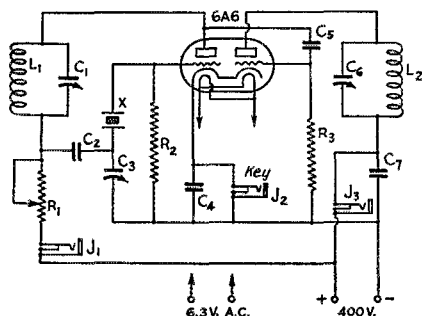

FIG. 1—CIRCUIT DIAGRAM OF THE THREE-BAND CRYSTAL EXCITER

C_1 —100- μ fd. midget for 160 and 80 meters; 50- μ fd. midget for the higher-frequency bands.

C_2, C_7 —0.002- μ fd. mica.

C_3 —100- μ fd. midget variable.

C_4, C_5 —100- μ fd. mica.

C_6 —50- μ fd. midget variable.

R_1 —5000-ohm, 20-watt with slider.

R_2 —50,000-ohm, 1-watt carbon.

R_3 —50,000-ohm, 2-watt carbon.

J_1 and J_2 —closed-circuit meter jacks for osc. and doubler plate current.

J_3 —Closed-circuit jack for key

L_1 and L_2 —

All coils are 1½-inch diameter. The 160-meter coil is made of number 22 enameled wire, while the remainder are made of No. 18 enameled.

Band	No. Turns	Winding Length
160-meter.....	65	2 inches
80-meter.....	32	1½ inches
40-meter.....	16	2 inches
20-meter.....	8	1½ inches
10-meter.....	4	1
5-meter.....	2	—
2.5-meter.....	1	—

operated on the 160- or 80-meter band, an oscillator plate tuning condenser of at least 100- μ fd. maximum capacity should be used; otherwise each of the two plate tuning condensers should have 50- μ fd. capacity.

For operation of the oscillator at crystal output frequency, condenser C_3 should be shorted. Provision for this may be arranged by slightly bending the corner of an outside rotor plate so that it makes contact with a stator plate at full mesh of the condenser. For doubling frequency in the oscillator, C_3 is used to provide regeneration—a decrease of the capacity of C_3 results in increased regeneration and increased output. If the adjustment of this condenser is carried too near minimum capacity, self-excited oscillation of the stage will be the result. Accordingly, a careful check of the oscillator output should be made to determine whether changes of adjustment result in proper operation.

The r.f. power obtainable from this small unit is approximately five watts on 160, 80, and 40 meters, and corresponding lower outputs on the higher-frequency bands. Using a 10-meter crystal, sufficient power is obtainable on 2½ meters to make a 2½-volt, 60-ma. bulb glow with normal brilliance, and it is thus enough to excite an 807 to several watts output on this band.

—Marvin C. M. Lane, W2LCR

Receiver as Neutralizing Indicator

DID you ever try to neutralize an amplifier without a neon bulb or any other of the usual indicating instruments except the receiver? Here is a method:

Turn on the oscillator only. Tune the receiver to the frequency of the oscillator and listen to the note while the amplifier neutralizing condenser is being adjusted. Each time a small change is made in the neutralizing condenser setting, swing the amplifier plate tuning condenser slowly through its entire range. If the note produced in the receiver by the oscillator changes, reset the neutralizing condenser. Do this until a setting of the neutralizing condenser is found at which no change in the note may be detected while tuning the tank condenser. Remember that in tuning any amplifier the plate supply must be disconnected, but don't disconnect the plate supply by taking the clip off the top of the tube (if the amplifier uses a top-cap plate connection) because

this breaks the r.f. circuit. This last may sound foolish to the expert ham but many old-timers and many beginners alike have made this mistake and then wondered what was wrong!

—Ross F. Cutting, W8KQZ

Need More Neutralizing Capacity?

THE capacity and the breakdown voltage of a neutralizing condenser may be increased by insertion of high-dielectric material between the plates. Two somewhat similar methods for doing this have been suggested, and are given below.

"The range of those neutralizing condensers which lack sufficient capacity to neutralize 203-A and 212-D tubes may be increased by insertion of $\frac{1}{8}$ -inch bakelite sheet between the plates," writes Will A. Bell, W6JXS. "The bakelite should be cemented securely to one of the plate surfaces to insure that all effective areas be parallel. The condenser air gap (distance between surface of the bakelite and the metal surface opposite) ordinarily should be approximately $\frac{1}{16}$ -inch. Other dielectric materials may be used, but consideration of dielectric constant should be used in their selection."

Erwin Aymar, Tegucigalpa, Honduras, C. A., gives the following note: "To raise both the maximum capacity and the breakdown voltage of a transmitter neutralizing condenser such as one of the National NC series, it is only necessary to place a piece of window glass on the lower plate. The glass should be cut so as to extend a quarter of an inch or so beyond the edge of the plate."

A table of breakdown voltages and dielectric constants of sixteen insulating materials is given on page 43 of *The Radio Amateur's Handbook*, 1938 edition.

Simplifying the Rotary Antenna Mechanism

A BEAM antenna rotating system which is little short of ideal for amateurs having basement and first-floor operating positions is shown in Fig. 2. Outstanding among its features are the following: Simple mechanical arrangement for turning the beam; economical, easy-to-build, rigid construction of supporting parts; and freedom from the unsightly and costly masts, poles and guy wires usually associated with rotary beam installations.

A piece of 4-inch by 4-inch wood 33 feet long forms the main stem

of the assembly. Fittings of $\frac{3}{4}$ -inch pipe and a ball joint are used to bear the weight of the wood column and serve as a pivot. At W8EEP, this base is located on the ground just outside the basement window. A steering axle and steering wheel is located above the operating table opposite the column of the antenna structure. The axle is equipped with a bicycle sprocket fastened

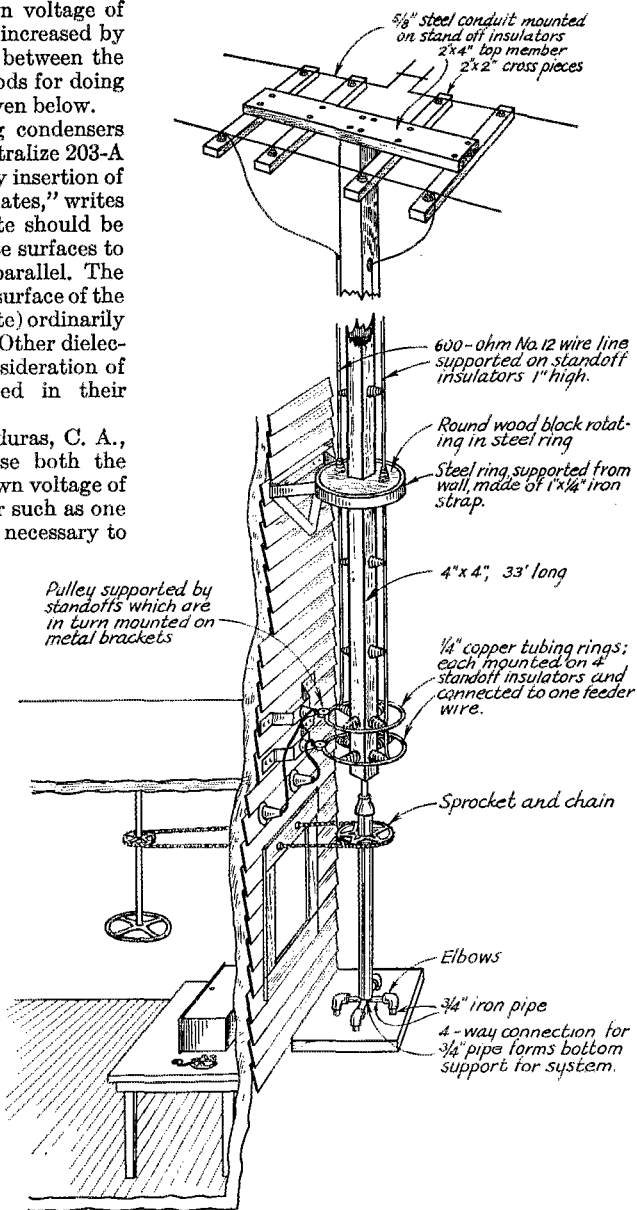

FIG. 2—CONSTRUCTION OF THE ROTARY ANTENNA MECHANISM

at the height of the top of the window frame, and two bicycle chains fastened together are used to connect this sprocket with a similar one at the same height on the column outside. Two small holes bored through the window frame allow passage of the connecting chain.

A bracket for holding the column in vertical alignment is fastened to the house near the roof directly above the basement window. This bracket, conveniently located at the top of a second-floor window, is made of $\frac{3}{4}$ -inch angle iron stock, and is provided with a band of strap iron made of two semi-circular sections bolted together. A round wood collar is made from four pieces of heavy board, so that it makes a snug fit when assembled and screwed on the column. The outside edge of this collar serves as a bearing against the iron aligning ring.

The top of the wood column is cut off square, and a simple light framework for holding the 10-meter radiator and reflector is mounted on it. A $\frac{5}{8}$ -inch steel conduit is used for the antenna elements, which are held in place by $4\frac{1}{2}$ -inch standoff insulators. The two halves of the radiator are each 8' 1" long, and are fed by a V-match from an untuned transmission line. The reflector elements are 7' 11" long, and the center ends are bent at right angles to form an adjusting stub of 2-inch spacing and 6-inch length. A shorting bar is moved along this stub to obtain an optimum setting. The pieces of $\frac{3}{8}$ -inch conduit, thus arranged, form a half-wave radiator and a somewhat shorter director spaced $1/10$ - to $1/8$ -wavelength apart.

Connection of the center ends of the radiator may be made through a similar adjusting stub if desired. Number 12 wire is used for the transmission line, and a spacing of 6 inches is employed. The ends of the line are "fanned" apart at the connections to the radiator, being adjusted to give minimum indication of standing waves on the feeders.

The 6-inch spacing of the transmission line is maintained along the column by use of 1-inch standoff insulators mounted centrally on opposite sides along the 33-foot length of the column. Diametrically opposite holes are bored in the wood bearing collar, and feed-through insulators here serve to maintain rigid and correct spacing of the conductors.

In order to make connections to the feeders which allow continuous and unlimited rotation of the system, two rings of $\frac{1}{4}$ -inch copper tubing are mounted on standoff insulators around the column immediately above the outside sprocket. One pulley, assembled on the top of a standoff insulator, is mounted on the end of a bracket for each of the two connecting rings, and a small spring is used to keep a contact pressure of the pulley on the ring. The conductor ending in the lower ring is carried inside the upper ring, so that no interference with the upper pulley is possible.

If desired, two pulleys could be mounted on separate arms for each of the contact rings, and the pulleys could be kept tight on the ring by means of a tension spring between them.

—R. J. Blaho, WSEEP

How Would You Do It?

(Continued from page 59)

the keying tube and was used in conjunction with a conventional 6L6 tetrode oscillator circuit.

Although the circuit of Fig. 2B involves the use of a keying tube, it would appear to have certain advantages over the circuit of A; it permits stopping oscillation entirely and the use of the keying tube should be effective in eliminating key clicks.

Two novel systems in which keying is introduced in the crystal circuit are shown in Fig. 3. In the circuit at A, a back-contact relay short-circuits the crystal when the key is open. VE3SA has had very good results with this arrangement, even when crystals of poor activity were used. The contacts of the relay should be well insulated.

In the version suggested by W11AP, shown in Fig. 3B, the keying-relay contacts are connected in series between crystal and ground.

"Without doubt, every ham has to find an answer to the problem of key clicks or be ostracized by his neighbors. A similar situation developed at W8NMH, station of the Clarkson College Radio Club, located on the school campus amidst a multitude of b.c. receivers. So we started to find an answer to this problem of a clickless and chirpless keying circuit. The one finally developed works exceedingly well. I do not know that the idea is new, but I have never heard of it before. Here at the shack we have a b.c. receiver and the transmitter may be keyed without causing interference of any kind. Chirps were eliminated by adjusting the cathode resistance so that the tube drew essentially the same current with key open or closed. This places a constant load upon the oscillator plate-voltage supply permitting no variation in voltage output. A Type 6L6G was used in the oscillator.

"In tuning the oscillator, it was noticed that the screen current varied from two to six milliamperes while tuning the plate circuit through resonance while the plate current changed hardly at all. The screen current is therefore used as an indication of resonance rather than the plate current. Link coupling to the following stage is used and the oscillator is lightly loaded.

"One might expect trouble with this method since the tube is called upon to dissipate considerable power when the key is open. No difficulties have been experienced so far; if the 6L6G does not last as long as it might under other conditions, it is worth this loss to maintain a clickless and chirpless signal.

"The variable resistor across the relay contacts

(Continued on page 118)

• I. A. R. U. NEWS •

Devoted to the interests and activities of the

INTERNATIONAL AMATEUR RADIO UNION

Headquarters Society: THE AMERICAN RADIO RELAY LEAGUE, West Hartford, Conn.

MEMBER SOCIETIES

American Radio Relay League
Asociatia Amatorilor Romani de Unde Scurte
Associazione Radiotecnica Italiana
Canadian Section A.R.R.L.
Ceskoslovenski Amatéri Vysilaci
Deutscher Amateur Sende-und-Empfangs Dienst
Esti Raadio Amatoride Ühing
Experimental Radio Society of Egypt
Experimenterende Danske Radioamatorer
Federation des Emetteurs Belges
Irish Radio Transmitters Society

日本アマチュア無線聯盟 Japan
Liga Colombiana de Radio Aficionados
Liga Mexicana de Radio Experimentadores
Magyar Rividhullamu Amatőrök Országos Egyesülete
Nederlandsche Vereeniging voor Internationaal Radioamateurisme
Nederlandsch-Indische Vereeniging Voor Internationaal Radioamateurisme
Newfoundland Amateur Radio Association
New Zealand Association of Radio Transmitters
Norsk Radio Relæ Liga

Polski Zwiasek Krotkofalowcow
Radio Club de Cuba
Radio Club Venezolano
Radio Society of Great Britain
Rede dos Emissores Portugueses
Reseau des Emetteurs Français
Reseau Luxembourgeois des Amateurs d'Ondes Courtes
South African Radio Relay League
Suomen Radioamatöörlitto r.y.
Sveriges Sandareamatorer
Unión de Radioemisores Españoles
Union Schweiz Kurzwellen Amateure
Wireless Institute of Australia

Conducted by Byron Goodman

General:

The July, 1938, issue of the *T. & R. Bulletin* (R.S.G.B.) carries an interesting story on "The Dawn of International DX" by G2UV, of interest to any DX-minded ham because it gives a European slant on the early DX work across the pond. Read along with the American views carried in *QST* and "Two Hundred Meters and Down," it will round out your picture. . . . Apparently the summer-camp station of the E.D.R. (Denmark), OZ7EDR, was a big success again this year. It was set up for a week at Smidstrup Strand, and averaged about 60 visitors a day. More than 100 amateurs visited the camp, 80 of them staying overnight, and the guests included German, Swedish, and Dutch amateurs. The 85-watt station was never lacking in operators and, from the account in *OZ*, the gang left the camp happy, sun-burned, and well-fed. . . . New regulations giving Roumanian amateurs a more substantial position have recently been formulated and adopted, according to information received from the U. S. Department of State. . . . J. Mahieu, ON4AU, well known to all DX men, was recently elected Traffic Manager of the *Reseau Belge*. . . .

QSL Bureaus:

Following is the latest revised list of the foreign QSL Bureaus to which QSL cards may be sent for distribution. Many of these bureaus now refuse to handle SWL cards and reports, and therefore listener reports should be sent directly to the station.

Alaska: Dean Williams, Box 2373, Juneau.
Antigua: A. Tibbits, Box 43, St. John's.

Argentina: Radio Club del Argentina, Rividavia 2170, Buenos Aires.
Australia: Ray Jones, 23 Landale Street, Boxhill, Victoria.
Barbados: *see* Antingua.
Belgium: Baron Bonaert de la Roche, ON4HM, Chateau de Marchennes, Harvengt nr. Mons.
Bermuda: Alfred E. Redman, "Elsing," Middle Road, Devonshire.
Bolivia: Henry E. J. Smith, c/o Standard Oil Co. of Bolivia, La Paz.
Borneo: *see* Malaya.
Brazil: L.A.B.R.E., Caixa Postal 2353, Rio de Janeiro.
British Guiana: *see* Antingua.
British Honduras: D. Hunter, Box 178, Belize.
Canal Zone: Norman Miller, 15th Air Base Squadron, Albrook Field.
Ceylon: Radio Club of Ceylon and South India, P. O. Box 282, Colombo.
Chile: Luis M. Desmaris, Casilla 761, Santiago.
China: I.A.R.A.C., Box 685, Shanghai.
Colombia: L.C.R.A., Apartado 330, Bogota.
Costa Rica: Federico Gonzalez, Box 384, San Jose.
Cuba: Adolfo Dominguez, Milagros 66, Vibora, Habana.
Curacao: care A.R.R.L.
Czechoslovakia: C.A.V., Post Box 69, Praha I.
Denmark: Arne Hammer, OZ7D, Norre Aaby.
Dominican Republic: H. H. Gosling, Calle Cesar Nicolas Penson, Ciudad, Trujillo.
Ecuador: Carlos Cordoves, Box 30, Rio Bamba.
Egypt: F. H. Pettitt, Catholic Club, Mustapha Barracks, Alexandria.
England: R.S.G.B., 53 Victoria St., London, S. W. 1.
Estonia: E.R.A.U., Box 220, Tallin.
Federated Malay States: *see* Malaya.
Finland: S.R.A.L., Pohjola, Box 42, Helsinki.
France (and any country with prefix beginning with "F"):
Reseau des Emetteurs Francais, 6 Square de la Dordogne, Paris, 17°.
Germany: D.A.S.D., Cecilienalle 4, Berlin-Dahlem.
Greece: C. Tavanotis, 17-a Bucharest St., Athens.
Guam: C. R. Spicer, Naval Communication Office, Agana.
Haiti: L. F. Sherwood, c/o R.C.A., Port-au-Prince.
Hawaii: James F. Pa, K6LBH, 1416D Lunalilo St., Honolulu.
Hong Kong: H.A.R.T.S., Box 651.

Hungary: National Union of Hungarian Short Wave Amateurs, VIII, Maytaster 6, Budapest.
 India: B. M. Tanna, Satya Sadan, Santa Cruz.
 Irish Free State: I.R.T.S. 23, Sth. William St., Dublin.
 Italy: A.R.I., Viale Bianca Maria 24, Milan.
 Jamaica: Cyril M. Lyons, 2-B North St., Kingston.
 Japan: J.A.R.L., P. O. Box 377, Tokyo.
 Java: *see* Netherland East Indies.
 Yugoslavia: Stephen Liebermann, Meduluceva 9, Zagreb.
 Kenya: R.S.E.A., Box 570, Nairobi.
 Latvia: L.R.B., Post Box 201, Riga.
 Lithuania: L.R.M., Post Box 100, Kaunas.
 Luxembourg: Service QSL de R. B., 164 Av. de la Fayette, Luxembourg.
 Madeira: *see* Portugal.
 Malaya (and Borneo): J. MacIntosh, c/o Posts & Telegraphs Dept., Penang, Straits Settlements.
 Mexico: L.M.R.E., Sinaloa 33, Mexico City.
 Morocco: A.A.E.M., BP 50, Casablanca.
 Netherlands: N.V.I.R., Post Box 400, Rotterdam.
 Netherlands East Indies: Ir. J. M. van Heusden, N.I.V.-I.E.A., Palmenlaan 1, Bandoeng.
 Newfoundland: Newfoundland Amateur Radio Assn., c/o E. S. Holden, P. O. Box 650, St. John's.
 New Zealand: N.Z.A.R.T., P. O. Box 489, Wellington.
 Nicaragua: Ernest Andreas, YN1OP, Estacion Radio-difusora Bayer YNOP, Managua.
 Norway: N.R.R.L., P. O. Box 2253, Oslo.
 Republic of Panama: R. D. Prescott, Box 32, Panama.
 Palestine: Frank H. Pettitt, Catholic Club, Mustapha Barracks, Alexandria, Egypt.
 Peru: Radio Club of Peruano, Apartado 538, Lima.
 Philippine Islands: George L. Rickard, P. O. 849, Manila.
 Poland: P.Z.K., Bielowskiego 6, Lwow.
 Puerto Rico: Francis M. McCown, Family Court No. 7, Santurce.

Portugal: R.E.P., Rua Das Chagas 35, Lisbon.
 Roumania: Victor Cantunari, Str. Matei Basarab, 3 bis Buchresti IV.
 Salvador: J. Frederico Mejia, 7a Calle Poniente 76, San Salvador City.
 South Africa: S.A.R.R.L., P. O. Box 7028, Johannesburg.
 Southern Rhodesia: *see* South Africa.
 Spain: U.R.E., Apartado 262, Madrid.
 Straits Settlements: *see* Malaya.
 Sudan: c/o Frank H. Pettitt, Catholic Club, Mustapha Barracks, Alexandria.
 Surinam: care A.R.R.L.
 Sweden: S.S.A., Stockholm 8.
 Switzerland: U.S.K.A., Bern.
 Tanganyika: *see* Kenya.
 Trinidad: *see* Antigua.
 Uganda: *see* Kenya.
 Uruguay: U.S.W.C.G., Box 37, Montevideo.
 U.S.S.R.: C.B.S.K.W., 1 Samotechny Per. 17, Moscow.
 Venezuela: R.C.V., Torre a Madrices No. 8, Caracas.

SWL QSL Bureaus:

SWL acknowledgments are not handled by the Bureaus, but we are fortunate in having a bureau for those coming into the United States. Amateurs acknowledging United States SWL cards should send them as follows:

Eastern U. S. (corresponding to W1, W2, W3, W4, and W8): H. S. Bradley, 66 Main Street, Hamilton, New York.

Western U. S. (corresponding to W5, W6, W7, and W9): Warren B. Mayes, 1438 South 11th Street, Maywood, Ill.

Navy Day Receiving Competition

October 27th

A MESSAGE to radio amateurs from the Secretary of the Navy will be transmitted on Navy Day, October 27th. In connection with this message A.R.R.L. will conduct the Fourteenth Annual Navy Day Receiving Competition. All amateurs are invited to take part in this activity, which constitutes amateur radio's participation in the celebration of Navy Day.

Two messages will be transmitted, one from Radio Washington (NAA), the other from Radio San Francisco (NPG). These messages will be substantially the same in thought but will vary slightly in wording. A letter of appreciation from the Navy Department will be sent to *every amateur* who makes perfect copy of the text of one message. Both messages may be copied, but only the best copy should be submitted in the competition. It is not necessary to copy both stations, and no extra credit is given for so doing. However, if both stations should be copied, please mention the fact when submitting your *best* copy so that the number of operators copying each station may be ascertained. Only the *text* (including any punctuation therein) of each message will count (not the preamble, break signs, and the like). Copy what you hear. Do not guess! Credit will of course be deducted for logging anything that was not actually transmitted!!

Mail copies for grading to the A.R.R.L. Communications Department, West Hartford, Conn. Send your original copies—recopying invites errors. An Honor Roll of letter winners and all other participants will appear in *QST*. The relative standings of the various Naval Districts will be determined by comparing the number of letters awarded with the number of copies submitted from each District. In submitting copy please mention it if you are a member of the Naval Communication Reserve.

Transmissions will be at approximately 25 words per minute and will be preceded by a five-minute CQ call on the following schedule: From Washington: NAA, 9:00 P.M., E.S.T., simultaneously on 4045 and 8090 kcs. From San Francisco: NPG, 7:30 P.M., P.S.T., simultaneously on 4045 and 9090 kcs.



OPERATING NEWS



Conducted by the Communications Department

F. E. Handy, Communications Manager

E. L. Battey, Asst. Communications Manager

The **A.R.R.L. Sweepstakes** is scheduled this year for November 12th-13th and November 19th-20th. Full details of this major activity in the operating field will appear in November *QST*. Get your station in prime condition for two week-ends of fun and QSO-opportunity. All set for the 9th annual SS!

Utilization of Operating Frequencies, Domestic and Foreign. A comparison of our use of amateur frequency bands in this country, with that reported by foreign members makes an interesting study. Tabulation of thousands of returns from a League membership questionnaire now makes some of the facts known. In the following table a percentage use comparison is followed by a ratio-of-use in which other figures are reduced to small round numbers to make comparison easy. The figures show mainly the distribution of amateur interest between the different bands, and do not give indication of the total numbers of amateurs active. The foreign membership return analyzed runs about 6 per cent that of the U.S.A. return.

PER CENT USE OF BANDS AND RATIO OF USE

Band	Domestic	Foreign	U.S.A. : Foreign
160 m 1.8 Mc.	1.067	.938	1 : 1
80 m 3.5 Mc.	30.91	6.98	5 : 1
40 m 7 Mc.	39.61	32.0	1 : .8
20 m 14 Mc.	25.308	50.26	1 : 2
10 m 28 Mc.	2.54	7.77	1 : 3
5 m 56 Mc.467	1.97	1 : 4
2½ m 112 Mc.071	.072	1 : 1
1¼ m 224 Mc.027	.01	2½ : 1
	100.00%	100.00%	
'Phone:			
160 m 1.8 Mc.	27.4	3.14	1 : 1
75 m 3.9 Mc.	18.9	17.35	1 : 1
40 m 7 Mc.	00.0	18.75	0 : α
20 m 14 Mc.	24.8	41.01	5 : 8
10 m 28 Mc.	13.5	7.22	2 : 1
5 m 56 Mc.	14.95	11.59	1 : .8
2½ m 112 Mc.28	.1	2½ : 1
1¼ m 224 Mc.17	.84	1 : 5
	100.00%	100.00%	

Referring to the table, 1.8-Mc. telegraph use is "comparable." Due to foreign restrictions and sharing with other services, 3.5-Mc. telegraph use is only 22.6 per cent as much. Amateurs of some countries do not have use of the band at all. Others may use only certain band sectors. Possibly the most valuable territory of all is our 3.5-

Mc. or domestic band in which useful emergency communication work and traffic organization go forward. Since the "other services," *not* hams, use so much of the low-frequency territory that is available to assign to amateurs (if governments want to), it is a correct observation that about all the average foreign amateur can do in operating is to work a little DX! The 7-Mc. telegraph work of foreign amateurs is 81 per cent that reported from U.S.A. members. On the 14-Mc. band the table shows 200 per cent foreign, or *double* our percentage use of telegraph for DX. Similarly, the 28-Mc. telegraph band has 300 per cent, or three times foreign-to-U.S.A. utilization, and foreign 56-Mc. telegraph is four times the U.S.A. percentage. This is due, we believe, not to any difference in popularity of bands, but to irksome restrictions, no allocations at all, power limited to ten watts or less, so that practical work is less effective, even where permitted in foreign nations, on the lower frequency amateur bands.

Coming to our radiotelephone comparisons: 1.8-Mc. 'phone work is but 11 per cent as common in foreign lands as in our own U.S.A. 4-Mc. 'phone has exactly comparable utilization. 7-Mc. 'phone, of which we have *none*, due to the narrowness of the band and our great numbers, is one fifth or 20 per cent of *all foreign amateur radiotelephone* operation! 14-Mc. 'phone rates 165 per cent as compared to U.S.A.'s 100 per cent. 10- and 5-meter telephone utilization is "down" in foreign lands. Perhaps there are fewer amateurs in the big cities to use "five" and a thinner distribution of amateurs in the population of other countries, or else u.h.f. equipment is harder to build or obtain. The 28-Mc. use is only about half what we experience. This is doubtless because 7- and 14-Mc. 'phone are satisfactory to foreign amateurs, who are less numerous, and have no elaborate special band classifications to limit QRM. An examination of foreign regulations (see index of such presentations in the I.A.R.U. section of back issues of *QST*), with comparison of our own, strongly emphasizes how lucky we hams are who operate amateur stations under the most liberal frequency assignments, in the good old U.S.A. Our VE-brothers also have regulations and assignments that correspond closely with our own. But elsewhere in the world, even where substantial fees are paid the governments by amateurs for their

licenses (for which qualifications in citizenship and code and theory is the only test in U.S.A.), the work permitted under licenses is extremely limited and part or all of certain frequency bands, even where available by international treaty, are prohibited by foreign government administrations.

Sportsmanship with E.C.O.'s. "Several DX stations have been heard complaining about e.c.o.'s parking right on the frequency of the station they were working and calling before they finished their QSO. Recently VK9DM told a W8 what he thought of him for doing it. A TF was trying to get his report from a W9, but gave up and left the air after asking the stations on the W9's frequency to stand by several times. HS1BJ hooked a W1, and in five minutes there were so many stations on the W1 tuning up and calling it was impossible for him to copy any of them." The above is from a U. S. amateur who also reports that on every desirable DX station mentions that he and other foreign station operators are going to SKIP THE WHOLE SELFISH BUNCH . . . and *instead* work just the stations that use common sense and proper sportsmanship.

From a DX ham, "They would have a better chance at working us if they would stay spread

out over the band, at least not all right on each other's frequency and on the unfortunate station that hooked us first. Some of the DX W's are 'scavengers' who find the frequency of the person I am working, swing their e.c.o.'s to his frequency, and bust up the QSO before it is well underway. Tell them to lay off, and stay on their own frequency, and I'll manage to hear and work a lot more of them."

Operators, patronize the A.R.R.L. QSL Bureau. An operator who has visited these United States but who is now on the air regularly from a foreign land writes, "Have sent a card to everyone with whom I have had a QSO, and to some others heard, but always to the QSL Bureau for their respective W-district. If they want their cards tell them to get them from their QSL Manager." Just consult the directory of the men in the nine U.S.A. and five Canadian Districts who run the QSL Bureau. Their addresses are elsewhere in this issue. Send the district manager a stamped, self-addressed envelope. Keep one always on file, and when there are communications for you they will be forwarded. Use your A.R.R.L. QSL service. It is organized to help you.

—F. E. H.

The Maxim Memorial WIAW—Dedication Relay

THE new WIAW received a grand send-off on the occasion of the Maxim Memorial Dedication Relay, held following the dedication ceremonies on Friday, September 2d. 479 messages of greeting and good wishes from League officials and members in 80 Sections were received by Connecticut stations during the period of the activity (6 P.M., Sept. 2d to sunrise, Sept. 3d) Miscellaneous deliveries by stations outside of Connecticut swelled the figures to an actual 551 messages received from 84 of the 70 League Sections!! The few sections from which no deliveries have been accounted for to date are So. Minn., Oregon, P. I., Utah-Wyo., Alberta and Sask.

The fact that 87 per cent of all messages received actually reached Connecticut during the approximate 12 hours of the Relay tells its own story of the outstanding success of the affair! The true spirit of T.O.M. was exemplified by the participation, which included many hundreds of relaying stations in addition to those from which messages were received. It was a most fitting activity to honor the memory of Hiram Percy Maxim and to launch the WIAW-Memorial on a course of "service to amateur radio," to which it is dedicated.

Included in the hundreds of greetings received were messages from 177 A.R.R.L. officials (10 Directors, 5 Alt. Directors, 9 Asst. Directors, 39 S.C.M.'s (including 4 Asst. S.C.M.'s), 77 R.M.'s, 20 P.A.M.'s and 17 E.C.'s). Twenty-seven amateur radio clubs and network organizations as well as a number of civic bodies added their felicitations. Space prevents publication of all the messages received but a few representative texts, typical of the spirit of the event, will be of interest:

"Former QSO's with Hiram Percy Maxim recalled with much appreciation. W8CMP hopes to have regular schedules with WIAW as soon as fall activities begin. Tentative frequency may be 3645 kc."—*Dr. E. C. Woodruff, W8CMP, President A.R.R.L.*
"May your antennas radiate good cheer the world around."—*George Bailey, W1KH, Vice-President A.R.R.L.*

"On this momentous occasion the Pacific Division extends greetings and welcome to our new Maxim Memorial Station."—*J. L. McCargar, W6EY, Director, Pacific Division.*

"Congratulations and best success to WIAW and A.R.R.L. on dedication of Maxim Memorial, 73."—*G. E. Brown, VE1EV, Route Manager, Maritime Section, Canada.*

"Success to Maxim Memorial Station."—*S. Roberts, G8QS.*
"Closely allied is the name of Hiram Percy Maxim with amateur station WIAW. One has been, the other will be, of great service to the A.R.R.L. It is fitting this date should be set aside for the dedication of this memorial."—*Floyd E. Norwine, Jr., W9EFC, Director, Midwest Division.*

"We of the West Gull Division wish the best of luck to WIAW hoping the call holds good until Gabriel blows his horn."—*Wayland M. "Scouty" Cross, W6NW, Director, West Gull Division.*

"The New England Division sends best wishes on the occasion of opening of the new Maxim Memorial Station. May its operation be the guide for all American amateurs, exemplifying all the friendly and helpful characteristics of Hiram Percy Maxim, 73."—*Percy C. Noble, W1BYR, Director, New England Division.*

"On this opening day of WIAW the N.V.I.R. extends best wishes to the A.R.R.L. in full realization of what its founders did for the amateurs all over the world."—*P. C. Vis, PA6MQ, President, N.V.I.R.*

"It's glorious to hear The Old Man's call and think of it ringing on through the Halls of Time."—*Norman E. Gibbs, W1JXP, Route Manager, Connecticut.*

"The American amateurs owe a great debt of gratitude to the memory of Hiram Percy Maxim, founder of A.R.R.L. It is fitting that the amateurs erect a lasting memorial to that great man to the end that his name shall ever be before them. The Southwestern Division of the A.R.R.L. is honored to have been able to contribute in a small way to his memorial."—*Charles E. Blalock, W6GG, Director, Southwestern Division.*

"May the new WIAW serve the amateurs through many years as did the man in whose name it is dedicated."—*Kenneth T. Hill, W3AHC, Director, Hudson Division.*

"The dedication of the Maxim Memorial is another important event in the history of the A.R.R.L. We are all happy that our founder's memory will be perpetuated among amateurs in this fitting way and we hope the memorial will ever be used for the advancement of the amateur cause."—*H. L. Caveness, W4DW, Director, Roanoke Division.*

"Hawaiian Section sends congratulations on dedication."—*Kaasht Nose, K6UGK, Asst. SCM, Hawaii.*

"An everlasting tribute to the memory of Hiram Percy Maxim. May it ever perpetuate his tradition."—*Edward C. Stockman, W9ESA, Director, Rocky Mountain Division.*

"Congratulations and we are sure T.O.M. is listening in from above."—Chester (Pa.) Radio Club, W3BKQ.

"May our WIAW be an honor to the memory of Maxim and the pride of our League."—Aar Cederstrom, W4AXP, Acting Secy, Western Florida, Southeastern Division.

"The A.R.R.L. is our beacon with Maxim as the foundation and your ideas the fuel. Congratulations."—J. V. Brotherson, W8BHN, Asst. Director, Atlantic Division.

"May the new WIAW enjoy the high prestige and esteem established by its ancestor, the LAW of Brian Percy Maxim."—F. A. Votles, W9BBL, Asst. Director, Dakota Division.

"Uncle Sam's boys send best wishes from the Cross Roads of the World."—K5AE, Fort Clayton, Canal Zone.

"Congratulations to headquarters staff and other participants in the tribute to our founder. May WIAW and the League carry on forever."—A. F. Moranty, W8CZT, Alternate Director, Central Division.

"The Delta Division sends best wishes. May the A.R.R.L. continue strong."—Eugene H. Treadaway, W6DKR, Alternate Director, Delta Division.

"The gang out West wishes new WIAW Memorial Station best of luck."—A. L. Smith, W7CCR, Alternate Director, Northwestern Division.

"The Washington Radio Club sends felicitations on the event of the Maxim Memorial dedication. May our new A.R.R.L. station's antenna forever radiate the true spirit of amateur radio."—Washington D. C. Radio Club.

"Congratulations from Unalaska, Aleutian Islands, Alaska. Wishing you best of luck and many schedules in future. 73."—Gang of Unalaska.

It was a busy night at WIAW! Operators Hal Bubb (W1JTD) and George Hart (W3AMR) kept the station in continuous operation from 6 P.M. until 6 A.M. They received 61 messages originating in 34 sections of the League's field organization. It seemed that everyone wanted to work the new station and for that reason AW could not spend much time with organized networks and relay routes. Those were well taken care of by other Connecticut stations. All U. S. districts, Newfoundland and the West Indies were worked during the course of the Relay, excellent signal reports being received from coast to coast, from border to border. The new WIAW certainly gets out. Reports indicate that the rhombic lays down a real signal to the west. Operation for the Relay was on 14-, 7- and 3.5-Mc. c.w., and 3.9-Mc. 'phone. In spite of the time spent in receiving traffic and in exchanging greetings with stations contacted, WIAW made 45 QSO's in 20 states during the twelve-hour period. It was the first real test for the Memorial Station and we believe "it has what it takes"!

It being impossible for any one station to receive the many hundreds of messages bound for WIAW, the aid of other Nutmeg State operators was enlisted in handling the traffic. For the purposes of the Relay "any Connecticut station" was considered as the destination of all messages. The Connecticut gang did a wonderful job, receiving practically all the messages that were originated. In previous relays of this type 30 or more hours have been allowed for traffic to reach Connecticut. In this affair the period was about 12 hours. In view of this fact the WIAW-Dedication Relay appears to be the most successful of its kind ever held! Joe Moskey, W1JMY, of West Hartford, was the outstanding Connecticut operator. Single-handed he received and delivered 108 of the messages! Nice work, Joe. Congratulations! All of JMY's operation was on 3.5 Mc. c.w. W1EAO received 35 messages on 3.9-Mc. 'phone, being the leading station for that band. On 1.75-Mc. 'phone W1DAV leads with 28; on 7-Mc. W1GCKX with 18; on 14-Mc. 'phone W1SZ (W1NI opr.) with 9; and on 56-Mc. 'phone W1KJT with 8. A tabulation of messages received and delivered by all Connecticut stations (aside from WIAW) follows:

W1JMY 102; W1KQY 44; W1EAO 35; W1DAV 28; W1GCKX 18; W1TI 17; W1UE 15; W1JXP 13; W1KXM 12; W1FAJ 11; W1BII 10; W1SZ W1TD 9; W1JHN W1KJT (via W1LFS/KLJ/LLL) 8; W1KKS 7; W1AOK W1HYW W1KFN W1KW 6; W1NIP W1JBJ 5; W1ACV 4; W1CUH W1GVV W1IAR W1JXV W1KSH 3; W1CPL W1GMR W1JQD W1JWL W1JYJ 2; W1BNB W1DHS W1JLJ W1JXR W1KDK W1KSN W1KSB W1KXB W1LKJ 1. Thanks, OM's, for making possible a successful relay!

STATIONS OUTSIDE CONNECTICUT

72 deliveries were made by stations outside Connecticut (practically all in nearby eastern states) that failed to get their traffic into the Nutmeg State during the period of the Relay. Relaying activity was high on the part of intermediate stations. Among the most outstanding in relaying quantities

were W4PL, W3ADE, VE3DH, W1EMG, W3EML, W6IOX, W3EFM (W2GVZ opr.), W1CPI, W1APK, W2JCY, W3AIR, W8NGC, W8ASW, W3EDC, W2ECL, W2DBQ, W9BAZ, W8QAN, W1EZ, W1EOB, W8KWA and W1GRV. W1DAV reports much assistance given by W1CPI and W1KAB in handling 1.75-Mc. 'phone traffic. Quite a few messages were collected on 56 Mc. and cleared on other bands. Several messages traveled from New Jersey and New York entirely by 56 Mc. Outstanding in 56-Mc. relay work were W2JCY, W1FHN, W3AIR, W1GRV and W1APK. One of the fastest relays was W7CWN's message, which traveled W7CWN-W4AXP-W1ACV (Conn.) on 7 Mc. within about nine minutes.

Among the clubs and networks which sent good wishes were the Chester (Pa.) Radio Club; Nashua (N. H.) Mike and Key Club; Society of San Francisco Amateur Radio Operators; South Jersey Radio Assn; Trenton Radio Society; High School Radio Club of St. Joseph, Mich.; Washington (D. C.) Radio Club; Halifax (N. S.) Amateur Radio Club; Bluefield (W. Va.) Amateur Radio Club; Westlake (Ohio) Amateur Radio Assn.; Springfield (Mass.) Radio Assn; Richmond (Va.) Short Wave Club; New Jersey QSP Club; Starved Rock Radio Club (Spring Valley, Ill.); 100 What Club (Modesto, Calif.); Tu-Boro Radio Club (Woodhaven, L. I.); The Milwaukee Radio Amateurs Club; The Iowa-Illinois Amateur Radio Club; Aberdeen (So. Dak.) Amateur Radio Assn; The Chair City Radio Assn. (Gardner, Mass.); Farmers Network 1840-kc.; Michigan QMN Net; North Carolina 75-Meter 'Phone Net; Virginia 75-Meter 'Phone Net; The Owl Network (1950-1980 kcs., coast-to-coast); So. New York State A.A.R.S. 'Phone Net; The Shore Line Limited Network (W1CPI, Skipper).

A memento of the Maxim Memorial Dedication and Relay is being mailed to each participant. It will provide each operator with a souvenir of his part in the making of Amateur Radio History! WIAW is now on the air on a regular operating schedule and is anxious to contact YOU! "Hal" and "Geo" assure you of a pleasant contact so give 'em a buzz
—E. L. B.

EI/GI DX Contest

THE Radio Society of Northern Ireland announces the Leonard Trophy Contest to be held on four October week-ends, the 1st and 2d; 8th and 9th; 15th and 16th; and 22d and 23d. In each case operation starts at 1200 GT Saturday, ends at 2400 GT Sunday.

The contest is open to all licensed amateurs. Only one operator per station is permitted; however, if more than one operator is used, each operator may submit an individual score. All stations must exchange RST reports before points may be claimed. Stations may be worked once only during the contest. All amateur frequencies may be used.

Contacts will be between EI and GI stations and stations in all other parts of the world. Points may be claimed as follows: For contacts between EI/GI and Europe, 1 point; Africa, above Equator, 2 pts.; Africa, below Equator, 3 pts.; North America, 3 pts.; South America, 4 pts.; Oceania, 4 pts. In the case of Irish participants, scores will be multiplied by the number of countries worked. United States and Canadian districts each count as a separate country.

The "Leonard Trophy" will be awarded to the leading Irish station for one year, as well as a replica for permanent possession. The leading station outside of Ireland will receive a gold medal, the second leading station outside a silver medal. All logs must reach the Hon. Secretary, R.S.N.I., H. F. Ruberry, 19, Little Victoria St., Belfast, Northern Ireland, on or before December 31, 1938. Look for the EI's and GI's during the periods of the contest.

Sixty-seven hams, XYL's and YL's registered at the annual Valparaiso, Fla., Hamfest, held under the auspices of Jimmy Long, W4KB, and his XYL, W4FAX. It was a grand success! W4APU, Southeastern Division Director, was master of ceremonies. 32 prizes were distributed. A real fish fry with all the trimmings was enjoyed by all. 56-Mc. transceivers added to the interest. Eastern and Western Florida, Alabama and Texas were represented.

PRIZES FOR BEST ARTICLE

The article by Mr. Arthur John Pinard, W9PTF wins the C.D. article contest prize this month. Each month we print the most interesting and valuable article received marked "for the C.D. contest." Contributions may be on any phase of amateur operating or communication activity (DX, phone, traffic, rag-chewing, clubs, fraternalism, etc.) which adds constructively to amateur organization work. Prize winners may select a 1938 bound *Handbook*, QST Binder and League Emblem, six logs, eight pads radiogram blanks, DX Map and three pads or any other combination of A.R.R.L. supplies of equivalent value. Try your luck. Send your contribution to-day!

"What Do You Talk About?"

By Arthur John Pinard, W9PTF*

ONE question which the amateur DX operator can seldom answer satisfactorily is, "When working foreign stations, what do you talk about?" It is a common question which ought to be simple to answer. Yet the usual attempts at an answer leave both parties in a state of confusion. The truth is that usually we don't talk about anything! Listen in on the 14-Mc. band some day to stations working DX and see how little originality is expressed in DX QSO's. The great majority of our QSO's sound as though they have all come out of an endless tape with only the call and report to distinguish one from another. No matter whether we are working England, Australia, Japan, South Africa or Pineapple Junction we open our QSO in the traditional manner: "r ok ge om es tnx vy fer call." This may have started as a routine operating practice, but it seems now to have become a ritual which, apparently, many feel cannot be omitted without committing a breach of amateur etiquette. It occupies many precious seconds of a DX contact.

Next we vary the routine slightly by sending "ur sigs rst 579x her in racine vly. condx fb hr hw? ar." Our second transmission is not likely to be much more interesting: "r wl om tnx vy fer qso es hpe cuagn 73 luck dx ar." If the station referred to is answering a CQ the second transmission is probably omitted. Now the above QSO form would not be particularly objectionable if it were used once and no more. But when we use the same form for hundreds and hundreds of QSO's, when every other station uses the same form or a slight variation of it for nearly every QSO, when the only difference between one QSO and the next is the call and the report (the QTH is often omitted), then it seems time that we question the value of DX communication. So great is the tendency toward routine communication that many operators do not even bother to copy the text and listen only for the report. It should not be inferred that a few poor operators are responsible for this condition. It is characteristic of practically all DX operators.

A clue to the tendency toward routine and lack of interesting matter may be drawn from the fact that we have long placed the emphasis upon quantity of QSO's rather than upon the individual quality of each. The mark of esteem is placed upon the operator who works more countries, or more districts than anyone else. When W8XYZ works 17 VK's in one morning he receives wide acclaim but when W8ZYX works one VK for 2½ hours it passes unheeded. We seem to work on the assumption that quantity of QSO's provides the most accurately measurable standard of operating ability. W8XYZ has not worked any farther than W8ZYX nor has he maintained communication as consistently, nor has he contributed anything toward ham friendship in rattling off 17 QSO's in a few hours. After a fellow has worked five or six VK's he can be fairly well cer-

* 1505 Flett Ave., Racine, Wis.

tain that he is getting out to Australia. There is no need of rolling up big totals to prove that to himself. In his next QSO with Australia he ought to try and inject a little originality. Of course, this is not always possible. Fading, QRM and weak signals are the big hindrances to enjoyable QSO's, but when reports of 569 or better are received at both ends there is no reason why a successful rag-chew cannot be carried out. In his first attempts at rag-chewing, the operator is likely to find that he has lost his DX contact. This is usually the case when transmissions are too long. There is not room enough in one transmission for the ritual and a friendly bit of conversation. Rather than lose the station we omit the conversation and just send the ritual. But why not do it the other way around? Why not cut out all the unnecessary routine matter instead? We do not even need to send the letters "RST" for nearly all amateurs now use the RST system. The QSO could start immediately with a report, omitting all of "r ok ge om es tnx vy fer call—ur sigs rst . . ." All we need to say is "r 579x" and then start the QSO out on a more original train of thought.

There are many interesting things that might be said in DX QSO's. At present we confine most of our remarks to QSL cards, although this is not much of a tribute to the efficiency of amateur radio communication. Ask the other fellow about his occupation, find out something about him—at least find out his name, ask him something about the country in which he lives, talk about current events, sports or radio, find out if you have any common interests. Don't talk politics with him if he lives in a totalitarian state. Try to win his friendship so that the next time you contact him he will remember you as a personality rather than as just another call. It is always a thrill to have a station 10,000 miles away open the QSO by calling you by name. After the ice is broken, the other operator will be interested in finding out about you and your station. Give him a little local color. Do these things and you will acquire his friendship much more rapidly than you ever will by a series of routine QSO's. Few amateurs can engage in DX work without finding that it stimulates their interest in the far-away places with which they talk. I recall one very pleasant QSO in which a Melbourne amateur and I arranged to trade newspapers. Needless to say I perused his copies of the *Melbourne Herald* and *Smith's Weekly* from the front page right through the classified ads. In a later QSO, the Australian amateur remarked that he had been very interested in the copy of the *Sunday Tribune* which I had sent him.

QSO's can very well be made informative if the operator is willing to put in a little extra effort and to exercise a little originality. Recently I heard a W6 open a QSO with a ZL by saying that he had found an old QSL sent to him by the ZL about 1930 on which the New Zealander had written that he was using 7 watts to a UX210 and that this was his first W6. "Them were the days," said the W6. The ZL apparently remembered and remarked that it was a wonder that he ever got over the back fence with that old rig. I left while the New Zealander was inviting the Californian to share some "refreshments" with him, and I feel sure that the QSO developed into a very interesting rag-chew which both parties will remember for another eight years. One QSO of this type does more toward building the prestige of a DX station than twenty of the "QRU 73" type. It puts truth into the assertion that amateur radio builds international friendship.

What say, fellas? Let's cut out the ritual, put some meat into our QSO's and dig up an answer to that paradoxical question—"What do you talk about?"

Hamfest Schedule

October 1st, at Schenectady, N. Y.: The Schenectady Amateur Radio Association's Annual Hamfest will be held Saturday, October 1st. Complete details are available from Roy D. Jordan, W2KUD, R.F.D. No. 7, Schenectady, N. Y.

October 2d, near East St. Louis, Ill.: The third annual auction of the Egyptian Radio Club is scheduled for Sunday, October 2d, at the club shack (W9AIU), 1720 South Chouteau Slough Road, north of East St. Louis, Illinois. Previous E.R.C. auctions have met with great success. The members

bring all their obsolete and extra apparatus for auction, the club taking a percentage of the proceeds. Free eats for all who attend. All hams are invited. There is plenty of room for picnicking and games. No charge of any kind. Visitors are not required to participate in the auction if they do not so desire. The auction will be in charge of Harold Jansen, W9DJG, and any further information may be obtained from him at 1110 Pine Street, Alton, Illinois.

October 8th, at Rutland, Vt: The Green Mountain Radio Club of Rutland will sponsor the 1938 Vermont Hamfest. The date: October 8th. The place: Hotel Bardwell, Rutland, Vt. Registration fee of \$1.50 will cover everything, including a \$1.00 Vermont Turkey Dinner. A 56-Mc. treasure hunt, various contests and well-known speakers will round out the program . . . and, of course, there will be prizes! The "committee in charge of arrangements" is working hard to make this the best hamfest in the history of ham radio in the Green Mountain State. For further details write Robert C. Teachout, W1FSV, 42 Pine St., Rutland, Vt.

October 9th, at Poplar Bluff, Missouri: The next quarterly meeting of the Moarky Amateur Radio Assn., composed of members in Southeast Missouri, Northeast Arkansas and Western Kentucky, will be at Poplar Bluff, Mo. on the second Sunday in October, the 9th. Visitors are more than welcome! Worth-while attendance prizes will be given. Two technical lectures are scheduled. There will be plenty of fun for all. This meeting is under the auspices of the Poplar Bluffs Licensed Radio Amateur Operators Assn. Additional details may be secured from H. C. Young, W9VDG, Sec'y-Treas., Moarky A.R.A., Sikeston, Mo.

A.R.R.L. Headquarters Operators

Hall Bubbs, "Hal," Chief Opr. W1AW.
George Hart, "Geo," 2nd Opr.

The following calls and personal sines belong to members of the A.R.R.L. Headquarters gang:

W1AL, J. J. Lamb, "jim"
W1AW, A.R.R.L. Headquarters
W1BAW, R. B. Beaudin, "rb"
W1BDI, F. E. Handy, "fh"
W1CBD, C. B. de Soto, "de"
W1DF, George Grammer, "gg"
W1EH, K. B. Warner, "ken"
W1ES, A. A. Hebert, "ah"
W1GS, F. C. Beekley, "beek"
W1INF, A.R.R.L. Headquarters Operators Club
W1JBJ, Thomas W. York, "tom"
W1JEQ, Vernon Chambers, "ve"
W1JFN, A. L. Budlong, "bud"
W1JPE, Byron Goodman, "by"
W1JTD, Hal Bubbs, "hal"
W1LJI, Thomas M. Ferrill, Jr.
W1SZ, C. C. Rodimon, "rod"
W1TS, Don Mix, "don"
W1UE, E. L. Battay, "ev"
W3AMR-1, George Hart, "geo"

DX Century Club

NEW MEMBERS this month: W2CYS, W3EDP, W2HHF, W3EVW, W8BTI, VE3KX, W3EMM, ZL1HY, W4CEN and W9ADN. Welcome, OM's, and congratulations! The fight for leadership is mighty keen of late, and this round we find W1SZ second-high and W1TW third. The boys are sure that W8CRA is holding out on 'em, but he's not doing so badly at that!

Note the addition of a special listing for radiophone. W2LXY is the first operator to submit proof of contacts with 75-or-more countries using radiophone exclusively. For first-listing under the "radiophone" heading it is requested that 75 or more confirmations be submitted. In order to ease the detail of keeping the records straight, please do not request radiophone credits until you have at least the

required 75. This also applies to the regular listings, of course.

The A.R.R.L. Century Club and "75-or-more" listings represent the only official confirmed countries worked list in existence! Send in your confirmations when you can qualify for at least 75 countries, including (please) sufficient postage to finance the return of your QSL's. In order to insure the safe return of your confirmations it is suggested that you send enough postage to make possible their return by *First Class Mail, Registered!*

MEMBERS, DX CENTURY CLUB

G6WY (No. 5)...	137	W6HX (No. 21)...	107
W1SZ (No. 7)...	129	W8LEC (No. 25)...	107
W1TW (No. 3)...	128	W9GDH (No. 41)...	107
W8CRA (No. 1)...	126	ON4UU (No. 31)...	105
W6CXW (No. 4)...	124	W9PST (No. 35)...	105
W8DFH (No. 14)...	124	G6RH (No. 36)...	105
W6GRL (No. 15)...	124	W6GAL (No. 50)...	105
OM4AU (No. 40)...	124	W2BHW (No. 39)...	104
GZTQ (No. 6)...	123	E1SF (No. 19)...	103
W1TS (No. 9)...	121	G6KP (No. 45)...	103
W2GTZ (No. 12)...	121	W4CBY (No. 20)...	102
W1BUX (No. 2)...	118	W6FZL (No. 48)...	102
W1LZ (No. 10)...	116	VK5WR (No. 49)...	102
W2GW (No. 11)...	115	F8RJ (No. 8)...	101
W6KIP (No. 28)...	115	J5CC (No. 46)...	101
W8BTI (No. 56)...	114	W2CYS (No. 52)...	101
HB9J (No. 13)...	112	W3EDP (No. 53)...	101
W9ARL (No. 18)...	112	W2HHF (No. 54)...	101
W2GT (No. 32)...	112	VK3KX (No. 57)...	101
W9KG (No. 16)...	111	W4CEN (No. 60)...	101
W8OSL (No. 23)...	111	G6CL (No. 24)...	100
W7AMX (No. 26)...	111	W5VU (No. 38)...	100
W1DF (No. 29)...	111	W9KA (No. 42)...	100
W8JMP (No. 22)...	110	PA0XF (No. 43)...	100
W8DHC (No. 27)...	110	W9EF (No. 44)...	100
W8OQF (No. 30)...	110	W2CJM (No. 47)...	100
W2UK (No. 33)...	110	W3EVT (No. 51)...	100
W6ADP (No. 34)...	109	W3EVW (No. 55)...	100
W8DWV (No. 17)...	108	W3EMM (No. 58)...	100
W5BB (No. 37)...	108	ZL1HY (No. 59)...	100
		W9ADN (No. 61)...	100

The following have submitted proof of contacts with 75-or-more countries.

W1DCK... 99	W3JM... 88	W8DOD... 81
W1JPE... 99	W8BOX... 88	W9FLE... 81
W1JCE... 99	W8KTW... 87	W1GNE... 80
W1WV... 98	W9AEH... 87	W3BYN... 80
W2GVZ... 98	F8AB... 87	W3EPR... 80
W2OA... 98	G2DZ... 87	W6GPE... 80
F8RR... 97	PA0QZ... 87	W8DGP... 80
W1CC... 96	W3FRY... 86	G2MI... 79
W8ADG... 96	W1BGY... 85	VK6SA... 79
W4AJX... 95	W4CCH... 85	W1EWD... 78
PA0QF... 95	W4MR... 85	W2IOP... 78
G5RV... 94	G6GH... 85	W8AAT... 78
W2CBO... 93	VE2EE... 85	W8FJN... 78
W2DC... 93	W3ZX... 84	W8MTY... 78
W3DDM... 93	W4CFD... 84	W9UM... 78
W3GAU... 93	W8AAJ... 84	G6YR... 78
W8EUY... 93	W8AU... 84	VE2GA... 78
W4BPD... 92	W8BSF... 84	W1ICA... 77
W1GDY... 91	W1HX... 83	W2GRG... 77
W1ZL... 91	W2BYP... 83	W3EMA... 77
W3BES... 91	W3AIU... 83	W3OP... 77
W3EPV... 91	W6ITH... 83	W9OVU... 77
VE2AX... 91	W8OXO... 83	W2DSB... 76
W4DRD... 90	G5QY... 83	W6LDA... 76
G2TR... 90	HB9X... 83	W8LZK... 76
SU1WM... 90	W1GCX... 82	G5BD... 76
W1ADM... 89	W9CWW... 82	G6ZO... 76
W5KC... 89	SPIAR... 82	ZS2X... 76
W6BAM... 89	W1BFT... 81	W3AGV... 75
W8CJJ... 89	W5ASG... 81	W3CKT... 75
W8KEG... 89	W6FKZ... 81	J2JJ... 75
W1FTR... 88	W6GHU... 81	PA0JMW... 75
W1RY... 88	Radiotelephone	
	W2LXY... 77	

How's DX?

How:

Realizing that at last the neophyte ballad-writer has a really appreciative friend, many budding (and sometimes over-ripe) poets have submitted samples. We herewith present a poignant little thing that can be appreciated by any DX man. The author submitted proof of its authenticity, so it is no mere figment of the imagination.

DX AT LAST

I've got some cards from China,
And also from VK,
And when I nailed a Siamese,
I thought my luck OK.

I have had my fill of fun,
When making such a call;
But this morning gave a thrill,
The biggest of them all.

The mail brought a request for card
From one who'd heard my sig—
It was a friendly SWL—
Two blocks from my rig!

—CM2AO

Where:

Things look fairly bright this month. By that we mean that through a slow process of elimination we're gradually getting the low-down on some of the questionable stations. For example, many of the lads had a hunch that P1IBV (T7, anywhere in high-freq. portion of 20) is not where his prefix says he is. To the contrary, he's very much authentic, although undercover of course, and asks you to QSL via A.R.R.L. He uses a pair of 48's in the rig, and *does* QSL! He's off for about a month now—some BGL QRM having brought him under suspicion—but will be back on from a new QTH. He asks you to emphasize that *no cards be sent to him direct* but only through the League Then, too, some of you will want to know about VQ8AA. Last



A BUNCH OF THE BERMUDA BOYS

In the front row, from left to right, VP9X, 9R, and 9H, and in the back, 9L, W2JRE, and 9G. 9X has been quite active on c.w. lately—he uses a 6L6-T20 rig with 35 watts input. 9R, Senior Health Officer of the island, is very well known on 20 'phone. 9H has been a ham since 1925 but has been inactive lately. 9L is a newcomer but rapidly making up for lost time, with 50 watts on 20 'phone. 9G runs about 75 watts to his 'phone rig on 10 and 20.

month we said he was phoney, the real SAA not having been on for some time. That was true, and the fellow you worked was in Trenton, N. J., which may or may not be DX for you. One of the local lads spotted his 28-Mc. harmonic and traced him that way. He won't be on again. The real one said he'd be on from August on Then there are those LX's that have been showing up from time to time. The Bureau over there has returned cards addressed to 1AG, 1AS, 1AH, 1AO and 1AW, and the only cards coming through from LX have been from 1CJ, 1AI, and 1TW. But W8OXO says that LX1AG gives his QTH as J. Marni, Rue de Parc, Wilz, Luxembourg. We suggest you make no mention of radio on the envelope. As Tabe says, "He may yet be pure! May he yet be pure!" We don't know about AC4YN, since W6KQK hasn't yet received a QSL for that contact. On the other hand, the AC4YR that a number of the boys worked is definitely a phoney, since AC4YN has told the lads that he's the only one over there in Tibet. Incidentally, one of the reasons that AC4YN can't put a better signal through is that he can't get any good masts—the Lamas object to cutting a single tree. It's part of the religion or something Don't pass them up as phoney if you hear stations using an "MX3" prefix. J2JJ says there are a number of them on, as well as some new MX2's. Old MX2B is now MX3C ZD2H (14,300 T9) says that ZD2G will be on the air soon. Cards can be sent to 2H's address: Art Tomlinson, Posts and Telegraphs, Lagos, Nigeria We tagged XU2BM a phoney some time back. Well, he wasn't in China, but he was in Asia, and if you worked him for WAC we *might* be able to get a QSL for you if you shoot one in. W6GCV gave us the dope Good clean living really pays off. We'd given up all hope on VP8B when he cracked through with a QSL. It seems that the old owner left for England but his son has been answering his correspondence. Then one of the operators at 8B, Reuben McLaren, set up VP8D and worked 16 QSO's with 10 watts input. Now McLaren is on with VP8AF (or 8AD) at the high-freq. end of 20. You can QSL to McLaren care Radio VPC, Falkland Island, S. A. In case you got all hot 'n bothered about EQ4AC, you'll be charmed to know that he's a W4 and not in Iraq as he says. Apparently he's illiterate too, else he could read that EQ would be in Iran and not Iraq W2BHW dug up one that may be a honey. He worked YA5XX (14,364 T9) at about 2 P.M. The fellow says he's undercover and to QSL via R.S.G.B. This ZP60J (14,420 T8) has brought forth a lot of conjecture. We aren't sure, but we know that Clyde de Vinna, W60J, has been making a picture for MGM down in Surinam, where the prefix is PZ, and if you took that, turned it around to make "ZP," and added it to "60J" you'd have—right! But it's only a guess VK4HN (14,300, 'phone or T9) is also in Papua in case you haven't worked VK4KC (14,400 T9) W1SZ worked ZA1D (14,415 T5) in the DJDC and thinks the fellow might be OK. The QTH he gave, Tirana, is on the map, which is quite a help. Or is it? HRIUZ (14,410 T8) asks to QSL via W2EIJ. Mail gets down there once every five weeks A crack at Tangiers, if you're on 'phone, can be had by looking for CN1AF (14,200). His address is Jose Sierra, 19 Rue des Sources, Tangier, IZ. G6WY and W2IXY have worked him W3BUI says that TA2A (14,300 T9x) is legit, but doesn't dare QSL because he's a foreigner there. However, if you send your card to G2BN he'll QSL this fall when he returns When YS2LR gets on 10, 20 and 40 this month he should find himself mighty popular. He asks that cards be forwarded care of W5FNX, Box 811, Brownsville, Texas In case you didn't grab VQ8AS (14,365 T9x) yet for Chagos, W4CEN says that 8AT will soon be on over there too. Tom says he worked some of those "wonder" stations—you know, "I wonder if he's a phoney?" Speaking of "wonder stations," W8JSU worked ZK2AG (14,425 T8) at

midnight, which might be a good one Frankly, we're skeptical about UR1BU (7100) worked at midnight by W8KLLH, and X12TM (7170 T7c) worked by W6PQW at midnight P.S.T. and claiming to be on Christmas Island W9MZF worked VK9DK (7150 T9), who looks good, but we don't hand VK9XX (14,360 T6) more than an even-money chance of being legit W5ACA heard AR8PK (14,410 T8) at midnight W5 time According to W5BB, we had it wrong about K6BAZ going to Samoa. At least he wasn't there but back at Hawaii when Tom worked him the other eve The correct address at KA4LH is L. H. Hinckley, c/o Tuba Project, Marsman & Co., Tagcauayan, Tayabas, P. I. He'll be on soon with a k.w. . . . W4BPD says ZK1AA (14,400 T9x) doesn't check on the beam and is a fake, coming in from the north or south instead of the way he should W8PQQ worked F08AC (14,405 T9x) the other yawning VQSAI (14,320) says his Call Book QTH is wrong, and to QSL via VQSAF You'd thank G2TR for letting us know that OX7OU (14,040 T9) is the Oxford University Greenland Expedition.

When:

You can't afford to pass up 28 Mc., because about the time your weary eyes get down to here that band should be wide open again. It isn't doing so badly at the time these lines are being hacked out. J2MI reports having heard K6 and W6 during the last of August and the Saturday and Sunday crowds have been having some fine meetings. VS6AG has a 'phone running down there.

That ole debbil 20 seems good at almost any time. At noon W8JSU hears J2JJ (14,395 T8), XU6AW (14,370 T7) and J2IT (14,405 T7) They're a little earlier down South, but W4CEN grabbed off XU8CM (14,300 T9x) and PK3EM (14,355 T9), and heard XU8GW (14,425 T9), XU8DS (14,380 T9), XU8NR (14,340) VS2AE (14,385 T9) CR7AU (14,350 T9) and CR7AF (14,280 T9) W9EF reports VS6AO (14,265) J2NF (14,430), J2KG (14,410), KA1BC (14,300) KA1RP (14,320) CR7AK (14,120) J3CG (14,405) and KA1ER (14,325)

W4BPD has a nice list, including as it does EL2A (14,300 T9x), ZD7A (14,415 T9), PK3AA (14,330 T9x), ZC6AQ (14,435 T7), VQ9AA (14,370 T9x) and U5HD (14,420 T6) The XU's are good in W5 around 8 a.m. W5EUN has CN8MJ (14,360), V4RAH (14,380) and CT2BD (14,350), while W5KC adds EA7AV (14,410 T7) XU6WS (14,420 T6) and TF2X (14,430 T9), QSL via TF3C W8KKG has nice ones in OY4C (14,370 T7) ZA1B (14,380 T9), VQ5AB (14,260 T8) and TA1AA (high end of 20, T6) W2BHW doesn't waste much time, and has LX1AX (14,430 T8), G6IA (14,100 'phone) on the Isle of Man, J8CD (14,400 T8) VS7JW (14,360 T9), ZM1AA (14,480 T9), VS8GJ (14,130, 14,400 T7) and PK1TM (14,205 T9) W9FERK reports K6OVN (14,300 T9) in Guam, LY1KK (14,320 T9), J3CX (14,275 T7) and VS7RF (14,340 T9) W9RBI adds U9ML (14,420), LY1S (14,100) and KA1FG (14,350) W9YEG has been really knocking 'em off, and his list includes ST2CM (14,330 T6), VQ3HJP (14,425 T5), UX1CP (14,430 T9x) and K6BAZ (14,395 T9) W8QQE tips us off to the fact that ZS3F (Southwest Africa) is now on 10 'phone. Paul has been working ZB1R (14,320 T9), VQSAI (14,320 T9) and VS3OL (14,430 T8c) W8EMM worked LZ1HD (14,275 T6), ZA1D and CR7AD (14,125 T9) W9VDY contributes CR9A (14,340 T6) and VE5ADX (14,040) at Great Bear Lake, Port Radium, N.W.T. W9HLE contributes XU8RL (14,305 T9), PK1RI (14,350 T9) and PK1MF (14,345 T9). W5BB says he doesn't think PK1MF can speak English because he gives everyone the same spiel Latest at J2JJ include ZB1P (14,380 T9), I7AA (14,380 T8), ST6KR (14,320, 14,400 T7), VQ2HC (14,300 T9x), OQ5AQ (14,360 T9), YA6XX (14,355 T9), ZA2E (14,270 T7) and PX2A were heard.

Who:

. . . . If you've wondered why a lot of the gals are wearing black these days, here's the answer. Dave Evans,

W4DZH, is taking the fatal step on October 15th, with a lovely lady from the land of oranges and kilowatts. Dave may show up later on 'phone and then again he may be boss. Time and Winchell alone will tell

Quite a few members of the Century Club were at the Chicago Convention—thirteen to be exact. They had a real bang-up DX meeting, presided over by W9KA, and from the looks of things the interest in DX isn't exactly lagging. ZL2JQ and PK3AT were also present at the meeting W5BB has it all figured out. If they are new they (1) are so snooty because of their popularity that you have to send your pedigree and cross their palm to get a card, or (2) they are "phoney," or (3) they will gladly work you, say "sure QSL" and take your card and Reply Coupons, and never answer! Tom must be only kidding, though, because he gives a song and dance about New England being a good DX location, when he knows it's the worst. (Jeeves, quit pushing that Century Club list in my face!) W5FDR reports FG8AH (7120 T5) is still on VP7NT just missed getting it when he left his shack only a few minutes before lightning demolished his gear FN1C writes to say that he is back on 14,200 and 14,085 kc., with an RK20 final. His only W so far has been W6LTM W6ITH passes along some 'phone dope. KA3KK (14,300) has a nice sock via a Vee beam, J2MI has a new ½-wave vertical that raps him through and, worse luck, J9PA has not been active lately. Reg worked VQ2HC (14,315) on 'phone the other a.m. PY2AJ, whom you should remember from 'way back, has just been made district attorney of Santos W8PHD tells us that ZC6AQ and SU1AQ are the same fellows but in the right countries though, in case you were getting worried. 6AQ decries the W's that park on the frequency of the station he's working and won't even let him finish a QSO. Nice friendly thing, this DX! W2ICY, visiting in Europe, says OK1FF needs only Nevada and Utah for his WAS W3ENX passes along the fact that ZL2CI (14,380, 14,012) is hunting Delaware with a vengeance W9RSO has real trouble. He heard someone signing his call and calling J2NF. That will come in handy during the next DX Contest, if the BL sends in a log too. Oscar works HR2ON (14,415), HK2CC (14,120) ZE1JI (14,350) and ZE1JG (14,345) YV5AD now signs YV4AE, and has YVAA9 for a portable call VP4TM has dismantled his rig and will soon show up in XZ2. He is ex-PK5PL On 160 'phone W9TNP has worked K6, K4 and VO and several VE5's, which sounds like DX on that band W8EUY is up to 102 with QSO's with OY4C, VQ3HJP, UK5KJ, VS7RP and FY8AA Latest at W2ENW are F18AC, XSVISM, I1MH, HB9CE, FASBG, PK1BX and ZE1JZ In the low-power contingent, W3EYF reports an average report of S7 in the DJDC, using only 35 watts to his 807 exciter, while W5FIT made his WAC with 25 watts to a 6L6 Tritet and a Q antenna OA4AB is now W2LNC, on 10 and 20 'phone W6NPY has been knocking off the Europeans with 300 watts into a vertical surrounded by telephone wires WIAPA and y.t. were "padding" around at the Maritime Convention together and we figured it all out. When we get on with a fake call it will be a good one: F1Y. Don't you get it? Tsk, tsk.

—W1JPE

A.R.R.L. Official Broadcasting Stations

The following listed stations address information regularly "to all amateurs" rendering a distinct service to fellow amateurs. First information on changes in F.C.C. regulations, new data on expeditions, special tests and activities, DX conditions and records of prime interest to the amateur world reaches amateurs first through the medium of League weekly broadcasts and the latest-revised list of stations that follows. Stations in all districts assure good coverage on the information which in many cases is so well sent it is used for code practice. Listen for the "QST" from these stations. Report results to the stations you copy too, so the operators

will know their signals are successfully received and appreciated.

WLACV, W1APK, W1ASI, W1AW, W1BEF, W1BKQ, W1BVR, W1BWY, W1EAW, W1EOB, W1GOJ, W1GZL, W1MNV, W1INW, W1IOT, W1EOR, W1JYJ, W1KFN, W1KIN.

W2AZV, W2FF, W2HZL, W2IXY, W2JGC, W2JHB, W2JKG, W2KIF.

W3AEJ, W3AOJ, W3AQN, W3BBV, W3BIG, W3BWT, W3CDQ, W3GWQ, W3ME.

W4AXP, W4CZA, W4DGS, W4DQY, W4EEE, W4EPT, W4QL, W4TO, W4VX.

W5ADJ, W5BLQ, W5BN, W5DKR, W5DWW, W5ECE, W5EST, W5FZJ, W5KC.

W6AM, W6FRW, W6GZY, W6ITH, W6JTV, W6MQS, W7BWH, W7DIS, W7FL, W7LH.

W8AQ, W8DED, W8DME, W8DZO, W8FWP, W8FZE, W8HCS, W8HOB, W8JQE, W8JRL, W8JTW, W8NDE, W8NEA, W8NEU, W8NNJ, W8NQS, W8NYY, W8OUT, W8RBI.

W9AXH, W9DBO, W9DDF, W9DEI, W9DUD, W9ECY, W9GBQ, W9HPQ, W9HUX, W9IPN, W9IYL, W9KEL, W9KHC, W9MOK, W9NGZ, W9OXC, W9PZU, W9RHH, W9RUJ, W9RZA, W9SYJ, W9TBF, W9TE, W9UEU, W9VMI, W9VWL, W9YWE.

CM2WW/CO2WW.
VE1EV, VE1KS, VE2EE, VE2HL, VE2HT, VE2HV, VE3PE, VE4LQ, VE5BJ.

W3EML, O.R.S., Philadelphia, offers speedy service on traffic for the Canal Zone. He maintains a twice-daily (except Sunday) schedule with K5AA, Fort Amador, at 6:00 p.m. and 10:45 p.m. Rush traffic sent at 6 o'clock often brings an answer via the later schedule. W3EML may be reached by any of the organized traffic routes.

ELECTION NOTICES

To all A.R.R.L. Members residing in the Sections listed below:
(The list gives the Sections, closing date for receipt of nominating petitions for Section Manager, the name of the present incumbent and the date of expiration of his term of office.) This notice supersedes previous notices.

In cases where no valid nominating petitions have been received from A.R.R.L. members residing in the different Sections in response to our previous notices, the closing dates for receipt of nominating petitions are set ahead to the dates given herewith. In the absence of nominating petitions from Members of a Section, the incumbent continues to hold his official position and carry on the work of the Section subject, of course, to the filing of proper nominating petitions and the holding of an election by ballot or as may be necessary. Petitions must be in West Hartford on or before noon of the dates specified.

Due to a resignation in the Oregon Section, nominating petitions are hereby solicited for the office of Section Communications Manager in this Section, and the closing date for receipt of nominations at A.R.R.L. Headquarters is herewith specified as noon, Monday, October 17, 1938.

Section	Closing Date	Present SCM	Present Term of Office Ends
Mississippi	Sept. 22, 1938	J. H. Weems, Jr.	Oct. 1, 1938
Tennessee	Oct. 3, 1938	B. G. Lowrey Smith	Oct. 14, 1938
Ontario*	Oct. 3, 1938	Fred H. B. Saxon	Oct. 15, 1938
Philippines	Oct. 3, 1938	George L. Rickard	Oct. 15, 1938
Oregon	Oct. 17, 1938	Eugene E. Lovcey (resigned)
Nevada	Oct. 17, 1938	Edward W. Heim	June 14, 1937
Vermont	Oct. 17, 1938	Alvin H. Battison	April 15, 1938
Nebraska	Oct. 17, 1938	S. C. Wallace	Aug. 17, 1938
Kansas	Oct. 17, 1938	Harry E. Legler	Oct. 29, 1938
Quebec*	Dec. 1, 1938	Stan Comack	Dec. 14, 1938
Colorado	Dec. 1, 1938	Glen K. Glasscock	Dec. 17, 1938
San Joaquin Valley	Dec. 1, 1938	Angelo V. Astone	Dec. 15, 1938
Louisiana	Jan. 3, 1939	Eugene H. Treadaway	Jan. 14, 1939

* In Canadian Sections nominating petitions for Section Managers must be addressed to Canadian General Manager, Alex Reid, 166 St. James Street, Quebec. To be valid such petitions must be filed with him on or before the closing dates named.

1. You are hereby notified that an election for an A.R.R.L. Section Communications Manager for the next two year term of office is about to be held in each of these Sections in accordance with the provisions of the By-Laws.

2. The elections will take place in the different Sections immediately after the closing date for receipt of nominating petitions as given opposite the different Sections. The Ballots mailed from Headquarters will list in alphabetical sequence the names of all eligible candidates nominated for the position by A.R.R.L. members residing in the Sections concerned. Ballots will be mailed to members as of the closing dates specified above, for receipt of nominating petitions.

3. Nominating petitions from the Sections named are hereby solicited. Five or more A.R.R.L. members residing in any Section have the privilege of nominating any member of the League as candidate for Section Manager. The following form for nomination is suggested:

Communications Manager, A.R.R.L.,
38 La Salle Road, West Hartford, Conn.

We, the undersigned members of the A.R.R.L. residing in the Section of the Division hereby nominate as candidate for Section Communications Manager for this Section for the next two-year term of office.

(Five or more signatures of A.R.R.L. members are required.) The candidates and five or more signers must be League members in good standing or the petition will be thrown out as invalid. Each candidate must have been a licensed amateur operator for at least two years and similarly, a member of the League for at least one continuous year, immediately prior to his nomination or the petition will likewise be invalidated. The complete name, address, and station call of the candidate should be included. All such petitions must be filed at the headquarters office of the League in West Hartford, Conn., by noon of the closing date given for receipt of nominating petitions. There is no limit to the number of petitions that may be filed, but no members shall sign more than one.

4. Members are urged to take initiative immediately, filing petitions for the officials for each Section listed above. This is your opportunity to put the man of your choice in office to carry on the work of the organization in your Section.

F. E. Handy, Communications Manager

ELECTION RESULTS

Valid petitions nominating a single candidate as Section Manager were filed in a number of Sections, as provided in our Constitution and By-Laws, electing the following officials, the term of office starting on the date given.

Santa Clara Valley	E. J. Amarantes, W6FBW	Aug. 15, 1938
Ohio	W8AC	Aug. 17, 1938
Western Mass.	W. J. Barrett, W1JAH	Aug. 17, 1938
Utah-Wyoming	E. E. Parrshall, W7CLG	Aug. 22, 1938
Southern Minnesota	Millard Bender, W9YNQ	Aug. 22, 1938
New Hampshire	Carl B. Evans, W1BFT	Sept. 1, 1938

Station Activities on page 104

BRASS POUNDERS' LEAGUE

(July 16th-August 15th)

Call	Orig.	Del.	Rel.	Extra Del. Credit	Total
W4PL	39	238	876	235	1388
W6IOX*	22	19	1207	14	1262
W7EQB	42	73	868	102	1085
W7DUE	6	21	848	42	917
K6NXP	317	100	338	95	850
W6ITH	124	216	288	194	822
W6JTV	96	244	196	206	742
W3CIZ	27	116	450	116	709
W3EML	47	155	342	145	689
W6DTH	5	61	498	60	627
W7WJ	12	18	582	10	622
W6IOX	5	8	557	6	576
W6LLW	28	61	436	50	575
W6IMI	34	70	380	60	544
W6CDA	6	43	428	39	516
W7FCN	14	20	433	25	502
W5MN	32	93	258	87	500

MORE-THAN-ONE-OPERATOR STATIONS

Call	Orig.	Del.	Rel.	Extra Del. Credit	Total
K4IHR	650	320	258	—	1228
W5QW	162	93	682	86	1023
W9NT	316	236	—	228	780
K5AA	312	83	236	60	691

These stations "make" the B.P.L. with total of 500 or over. One hundred deliveries + Ex. Del. Credits also rate B.P.L. standing. The following one-operator stations make the B.P.L. on deliveries. Deliveries count!

W9APF, 248	W3QP, 138	W5DKR, 123
W2HAM, 157	W7APS, 135	W6EJA, 112
W2JZX, 150	W1KH, 130	W7FNO, 104
W9FRC, 147	W6CZO, 129	

A.A.R.S.

WLHA (W8BBH) made the B.P.L. on 100 deliveries.

MORE-THAN-ONE-OPERATOR STATIONS

Call	Orig.	Del.	Rel.	Extra Del. Credit	Total
WLM (W3CXL)	126	81	1747	45	1999

A total of 500 or more, or 100 deliveries Ex. D. Cr. will put you in line for a place in the B.P.L.

* June 16th-July 15th.



CORRESPONDENCE

The Publishers of *QST* assume no responsibility for statements made herein by correspondents

Hawks As an Amateur

Muskogee, Okla.

Editor, *QST*:

It was with much regret that hundreds of amateurs like myself heard over the radio last night, or read in cold, black type this morning, these words—"FRANK HAWKS KILLED." The majority of the people of these United States remember Frank Hawks for his work in aviation, but to many of us he was a fellow amateur—W1IJI-W2GKL. His loss is our loss.

This morning I turned back through the files and in *QST* of the issue of January, 1934, on page 66, there was a letter written by Frank Hawks soon after he passed his amateur examination and obtained his license. Several things in that letter are deserving of our attention.

Although W1IJI had experienced more thrills in a year than most of us experience in a lifetime, he still got a thrill out of something that is common to all of us, namely passing the amateur exam. He said, "I was thrilled beyond words in passing the examination and receiving certificate and station license."

W1IJI did not make the mistake common to many new amateurs, that of going on the air with the maximum of input when finances will permit. Instead he chose to go on the air with flea-power until he gained the requisite experience.

Did he bust open the air with endless CQ's, or get impatient when he was slow in getting answers to his calls? No! Quoting his own words, "I spent the first three nights following A.R.R.L.'s recommendations, sent very few CQ's, twiddled the dials religiously to pick up others. I was not in the least optimistic in my own outfit, so I called stations in my own immediate district." That statement needs no further comment.

W1IJI was proud of his affiliation with A.R.R.L. His closing statement of the letter was ". . . and to the best interests of A.R.R.L., with which I am proud to be affiliated." . . . W1IJI has signed SK for the last time, but his memory lives on in the hearts of his thousands of friends and admirers, both in aviation and in his chosen hobby, amateur radio.

—Lester Harlow, W5CVO

Mfd. vs. Handmade

Berkshire, England

Editor, *QST*:

I am glad to see that Mr. Charles Olsefsky, W8RCL, drives an automobile which he made himself. That places him in a class with Malcolm Campbell, John Cobb and the men who race at Indianapolis.

No custom-built car is good enough for a racing driver. He sees every nut and bolt into place and knows the strength and function of the most obscure parts of his mount.

The man-in-the-street who ambles along in the family sedan has a perfect, safe and comfortable means of transportation—but it's not a racing car.

—Jack Paddon, G2IS

'Jareadit?

844 Bridge Road, Charleston, W. Va.

Editor, *QST*:

QST! How many of you mugwumps didn't read "It Seems to Us—" in the August issue of *QST*, featuring foreign broadcasts on 7200-7300 kc.? Uh-huh. Well, that's just how many more should have read it than did. Fellow Lids, it not only proves that K.B.W. can write a gud piece of readin' but it's one of the most blazingly hot journalizations that ever lighted up these orbs! Such headline phrases as "Let them squawk their bleeding heads off" (Hoot, mon!), "Whose band is it anyhow?" (You wouldn't think that K.B.'s innocent pan had this much heat behind it!), "It's their funeral," "There are plenty of other broadcast frequencies for them (American SWBL's) to listen to, if they yearn to be propagandized." And then he slaps 'em in the face: "We'll blast 'em off the air! We'll mow 'em down! And serve them right; bad luck to them, anyway!"

A FB article, inspiring you and me to stand up for our just rights, and warning us against "bad peoples" knifing us in the belly when our backs are turned. Bouquets to you, Ken OB, and also to any fullblooded ham that can read that page of condensed heat without jumping es shouting with glee (like I did) and sweating like a horse from its sizzling emission! Are you nearsighted? Then beware! Don't stiek ur billboard too close to page 7 of August *QST* or we'll have singed eyebrows for dinner. Hi, es CUL.

—Geo. H. Knapp, W8SFT

European Viewpoint

11 Palmerston Road, Rathmines, Dublin, Ireland
Editor, *QST*:

Your splendid account of the "Battle of Cairo" in *QST* for July should be printed and circulated to every ham in the world. This would, perhaps, waken the brotherhood to the determined attack now in progress to root out the ham, lock, stock and barrel, from the international picture and make them realize that drastic changes are necessary if we are not to meet our Waterloo at Rome in 1942!

On all bands to-day one is painfully made aware of the giddy irresponsibility of, I am sorry to say, the majority of hams. Ham Radio seems to be becoming more and more the happy hunting ground for cheerful chaps to indulge in small-town talk, informal parties, YL baiting and general ballyhoo! The genuine ham with a scientific interest in his hobby is being rapidly pushed out of the picture by these gay young sparks with their tailor-made rigs. Much as I deplore the curtailing of bands here in Europe I must admit that knowing the use that is being made here of our lower frequencies I can fully understand the administrations concerned being quite unscrupulous in their demands.

The last sentence in your article on Cairo is a potent one: "We have it in our own hands and it is chiefly a matter of conducting ourselves properly as individual amateurs." But I am afraid it is too late—the writing is on the wall.

—P. T. Daly, EI6G

QSLs, DX—A Racket?

Blue Bell, Pa.

Editor, *QST*:

This QSL business seems to have developed into a most pernicious racket, and I for one should like to see something done about it.

What is amateur radio? My definition of it is a personal means of communicating with others of the same interest at various points around the world. Nine out of every ten DX QSOs you hear run something like this: "r r r ok ok ok ur ur rst rst rst 569x 569x 569x hr hr hr in in in extown extown ur ur ur mi mi mi vi vy vy first first first x x x so so so pse pse om om om qsl qsl." After all continents have been worked, any operator has a fair idea of the directional properties of his antenna, the hours at which signals will often be heard from the various points of interest, and what band should be used to accomplish the contact.

What is then proven by the ability to show the neighbors a flock of DX QSLs? Can you take them into the station and work any one of these operators at any time? No. Can you be certain you will even hear any of them again, or that they will hear you, without a prearranged schedule? No. Does this QSL file make you any better at operating, or does it mean that all these men, who have spent good money to send you cards, must be your close friends? No.

The man is rare who has more than four or five really close friends, and the operator is rare who can handle schedules with four or five DX stations anywhere from daily to weekly, and the reason is that all the time one can give to pursuing a friendship is none too much to really learn to know that fellow well.

How much do the foreigners like it, when they are trying to have a chat with some friends over the air, to have a bunch of W stations land right on the station they happen to be working in order to try to break up the chat and horn-in themselves? Sport, maybe, for the W's, but extremely aggravating to the foreigner, and hardly conducive to kindly relations internationally. Taking the other extreme, suppose that the QSL card did not exist at all. Immediately the air would be free of the cajoling, pleading, begging, almost demanding of DX stations that they must send cards. This is not amateur radio: it is a racket, and it stands a good chance of spoiling the game for those of us who find something more useful in it than papering our walls. If any operator is sufficiently inspired by the QSO with some foreigner, let him place the proper postage on his card and address it to the man himself, and not dump it into the racket-barrel with a

million others, to be delivered or not, as the QSL-Bureau Manager may decide. A QSL card, if one is sent, should be a souvenir of something one wishes to remember with great pleasure; a friendship formed with someone with whom there is some thought or language or hobby or interest in common, one which will be a pleasure to resume and continue whenever conditions and time permit. . . . There is no place on this earth which cannot be worked if (1) you pick the right time of day, (2) the right band, (3) the right conditions, and (4) if there happens to be a station there and working under simultaneous conditions. So, if you know all this to start with, what is all the noise about? Even a souvenir hunter "can't take it with him."

—John B. Morgan, W3QP

Is It Fair?

Shanghai, China

Editor, *QST*:

In almost every QSO one can hear frantic requests for a QSL card, and also equally earnest assurances that that particular station will surely send his own confirmation. But just how many of them do so?

We who live in a far country attach an almost sentimental value to a confirming card. It is a breath from the outside world. An acknowledgment that the station worked was as good as his word. A contact with an operator who knows that to have certain privileges presupposes the same amount of obligations. It does seem though, as if the promise of a card were a matter of routine. And yet a promise is a promise. It does not matter if it pertains to a card or a more important matter.

Let us therefore be more outspoken. If an operator does not care to send his card, well and good. Only let him openly say so. It is at least an honest way of doing things. There may be operators who do not care for a card. That is quite in order. But then why beg the other fellow to send one? There is an operator here, and a very good one at that, who wished to help those taking part in a recent DX contest. He not only made contact with them—and XU contacts are not so very plentiful at the best—but sent them in the neighborhood of some 400 cards only to receive 16 in return. Is there anything fair about that?

—Robert Lang, XU8RL

Slant on Insulation

Port Isabel, Texas

Editor, *QST*:

I have had quite a bit of transmitter trouble due to inadequate insulation on tank and antenna condensers, being forced as I am by economic necessity to use BCL stuff. These condensers could be made electrically and mechanically efficient by just switching the insulation to isolantite or some other good insulation.

To date I have only seen one advertisement as to where this insulation could be obtained in sheet or strip form, and accidentally misplaced that.

It would be a boon to hundreds of amateurs like me, who have to closely watch the pennies, if they could obtain high class insulation cheaply. Of course, it might hurt the manufacturers a little, but for the hams whom the ARRL is supposed to help, it would be a big help. . . .

—Roy LeRoy, W5GUY

Rho Epsilon Fraternity

5822 E. Green Lake Way, Seattle, Wash.

Editor, *QST*:

Our letter in *QST* last April brought many inquiries for information regarding Rho Epsilon, and indicates a great interest in an inter-collegiate radio organization. Two new chapters were established last spring, and more will be established during the coming school year. We would like to renew our invitation to those amateurs attending colleges and universities to write the national secretary for information relative to establishment of a chapter of Rho Epsilon on their campus.

(Continued on page 76)

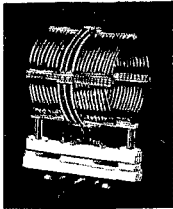

SO MUCH OF OUR SPACE in *QST* this month seems to be devoted to transmission equipment, that we might as well go the rest of the way and use this page too. There are a number of small points that we have been wanting to clear up for some time, so here goes.

The National Buffer Coils of the AR series (self-supporting air spaced bare copperturns) were somewhat underrated in our original announcements. The ability of a coil to handle power in a tuned circuit depends on its ability to dissipate its own losses in heat. The AR coils are so surprisingly efficient that they have very little loss to dissipate, so they can handle quite a little power in spite of their small size. Of course so much depends on the other parts of the circuit that it is hard to give precise figures, but after extensive tests in *average* circuits we find that they can readily handle 50 watts plate input. An input of 65 watts is about the safe limit. As the original rating was only 25 watts, this discovery seemed well worth telling you about.

In perfect fairness, we also should call your attention to the fact that another rating has been reduced. Through an oversight, the NTE was originally rated at 15 watts audio output. We corrected this figure to 10 watts in all of our later advertisements and booklets, but to avoid any possible misunderstanding, we want to call your attention to it now. The NSA Speech Amplifier *does* have 15 watts output (no mistake there)!

While on the subject of NTE ratings, the R.F. output of the exciter is not less than five watts. This is actual useful power, effective at the grid of the buffer. The output depends on the band, to a certain extent. The 6L6 frequency multipliers have enough gain to give some amplification in each stage, so that there is more power available at 10 meters, for instance, than there is at crystal frequency (80 meters). This is not true of 5 meters, where the output is a little less than at 10 meters, due to low tube efficiency. However, the output is never less than 5 watts, as mentioned above. One further point — when coupling the exciter, the link should be grounded both at the exciter and at the buffer, otherwise neutralization adjustments will be difficult and may not be the same for different frequencies. One side of the link circuit is grounded in the exciter at the factory, so care must be taken to get the same side grounded at the buffer.

The 600-watt transmitter is designed for use on 10, 20, 40 and 80 meters, and we are sorry we cannot give much help to those who have written to us asking how to use it on 160 meters and 5 meters. The NTE-B Exciter has a 5-meter range, of course, but the effective tank capacity in the final becomes too large for efficient operation above 30 MC and for this reason we made no attempt to design the associated circuits for frequencies higher than this. On 160 meters, on the other hand, the tank condenser capacities are rather too low, and furthermore there is no provision for it in the exciter. Of course, by making some compromises it is possible to build a transmitter to cover all bands from 5 to 160, but considering everything — efficiency, simplicity, cost and general usefulness — it seemed wisest to design for a smaller number of bands, with peak efficiency on each.

JAMES MILLEN



Make Control Replacements EASILY...QUICKLY...EXACTLY

With a Mere Handful of

P. R. MALLORY & CO. INC.
**MALLORY
YAXLEY**

MIDGET VOLUME CONTROLS and 17 PLUG-IN SHAFTS

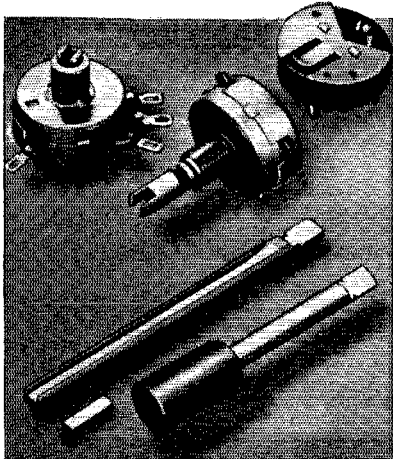

Mallory-Yaxley Midget Volume Controls have flexibility . . . adaptability . . . universality . . . and attachable switches where necessary. But overshadowing all these advantages is the Mallory-Yaxley Plug-In Shaft!

For example . . . 10 new Mallory-Yaxley Midget Controls plus 17 Plug-In Shafts give you the servicing range of 170 ordinary Exact Replacement Controls with fixed shafts. To cover the 56 known basic type controls with fixed shafts (so-called "specials") means a total of 952 individual controls . . . but Mallory-Yaxley Midget Volume Controls with Plug-In Shafts provide the same service range with only 56 controls and 17 Plug-In Shafts.

MR Midget Controls are satisfactory for many applications where special shafts and couplings are unnecessary. For complete details, see your distributor . . . or consult the Second Edition MYE for complete recommendations on 17,000 receivers.

P. R. MALLORY & CO., Inc.
INDIANAPOLIS INDIANA

Cable Address—PELMALLO

Use

P. R. MALLORY & CO. INC.
MALLORY
APPROVED RADIO
PRECISION PRODUCTS

Use

YAXLEY
APPROVED RADIO
PRECISION PRODUCTS

Correspondence Department

(Continued from page 74)

We also invite college radio clubs and amateurs having stations at school to join the National Inter-Collegiate Press Association, a net of stations sponsored by Rho Epsilon for the exchange of news for college papers.

—Niilo E. Koski, W7LD, National Secretary

A Little Matter of Telepathy

906 N. Vine St., W. Lafayette, Ind.

Editor, *QST*:

I had a very unusual experience on the air the other day, and I wonder if anything like it has ever happened to other hams.

A few months ago, a friend and I conducted some home experiments on mental telepathy, in which I am somewhat interested. We discovered nothing of exceptional merit, but after what occurred a few days ago, I am convinced that there is actually a firm foundation to the science.

Forty meters was still pretty well open at 11:21 A.M., C.S.T., when I answered a CQ from W8RDZ. We were well started on a good old-fashioned rag-chew when I heard the beginning of that familiar phrase, "handle hr is . . ." I recognized what was to come when the first word was half sent. Simultaneously, there popped into my head the word *Jerry*.

At the time, I realized what was in my mind, although I gave no conscious thought to it. The sentence continued, and I heard: "handle hr is Jerry." I had not been consciously searching for names, nor had I ever QSO'ed W8RDZ before. Neither had I ever heard of him, and I have no acquaintances named "Jerry." Because of these facts, I firmly believe that my subconscious mind divined the thought in the mind of the person to whom I was listening. The word was actually sent about ten seconds after it entered my mind, as we were conversing at about twelve w.p.m.

This may sound like bunk to some, but it actually happened just as I have told it.

—Ray C. Miles, W9KBL

A Visit to WIAW

(Continued from page 13)

uniformly, at each end of the band, without having to change feed line taps on the antenna circuits.

After a last look at the interior of the transmitters in which we observe tubes and parts of all kinds, the operator beckons us through the garage to take a look at the antenna systems. The masts themselves are impressive. They are self-supporting wooden poles, Oregon red cedars, five in number. They are 65-footers, each seven feet in the ground. Instead of unsightly ropes that involve counterweights and replacements, the antennas are suspended directly from the pole tops. Each pole is stepped all the way to the top to facilitate any necessary climbing. Even with a stout lineman's belt available few staff members have climbed to the top, although a splendid view is available. It is a long way down! To avoid stretching, the flat tops all are made up of copper-weld, for tensile strength and conductivity, while the down leads are of ordinary hard-drawn copper wire.

A diagram showing the disposition of antennas about the lot tells the whole story on which antenna goes with which transmitter. A dozen or more fourteen-foot feed line poles in the rear of the station carry the multiplicity of wires neces-

RAYTHEON

answers

3

AMATEUR PROBLEMS!



THE ANSWER FOR A ONE-TUBE RADIO REMOTE CONTROL SYSTEM

RK-62 is a gas-filled triode designed for use as a high sensitivity detector with a large enough plate current shift with signal to operate a relay. Operates on only 45 volts of B battery. Ideal for remote control. Filament 1.4 volts at 50 milliamperes. \$3.50 list.

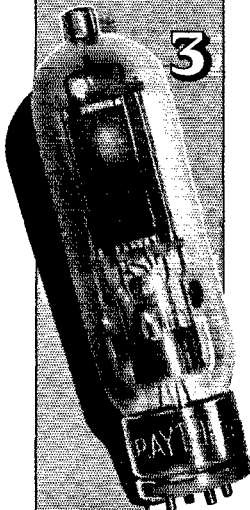

THE ANSWER FOR A ONE-TUBE FULL-WAVE POWER SUPPLY FOR THE SMALLER RIGS

The RK-60 is a full-wave rectifier capable of handling all of the smaller rigs (i. e., a pair of RK-39). Delivers 600 volts at 250 milliamperes. Filament 5 volts at 3 amperes. \$2.75 list.

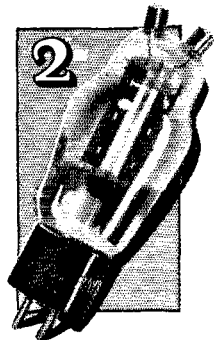

THE ANSWER FOR A LOW-COST TUBE FOR THAT BIGGER RIG

RK-57 is a real low-cost, high-powered, extremely low bias triode. Thoriated tungsten filament, carbon plate brought out at the top. 125 watts plate dissipation. At 1500 volts on the plate, 105 volts bias, a single tube (used in class C) delivers 215 watts. A pair of tubes (class B) at 1500 plate volts, 16 volts bias, produces 370 watts. At 1250 volts, the tube can be operated at zero bias. Filament 10 volts at 3.25 amperes. \$13.50 list.

RAYTHEON
RK
AMATEUR TUBES

Newton, Mass. • New York • Chicago • San Francisco • Atlanta

Treatise on Amateur Tube Uses and Theory

Don't forget your copy of Raytheon's new book. It presents complete information on tubes, their theory and proper application. Included in it is a valuable Temperature Color Chart, detailed chapters on modulation, L.C. ratio, driving power, ultra high frequency operation etc. Available at your jobber or write the nearest Raytheon office. Price 50c.



"WORLD'S LARGEST EXCLUSIVE RADIO TUBE MANUFACTURERS"

A Prophecy . . .

CLEVER constructors are using these, and other Cardwell units in modern transmitter designs. New developments will undoubtedly include these units with push button tuned tank circuits, with mechanical control of final tank capacitors. Oak Manufacturing Co. in Chicago has a 6 button mechanical tuner permitting, for example, two frequencies anywhere within the ranges of a 180° variable capacitor and its inductor, ON EACH OF THREE BANDS.

XE-160-70-XQ or FEX will supply the correct capacity ranges for modern coils, such as Barker-Williamson's.

Once tuned up, you switch in proper tank circuit, push the button for the desired frequency and your condenser is automatically moved to proper setting. Broadcast receiver practice simply applied to a transmitter tank circuit, that's all.

Like to have a dope sheet outlining the idea? Yours for the asking.

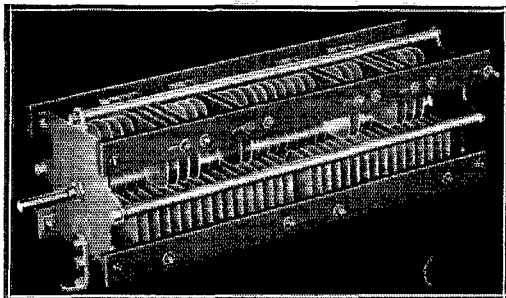

TYPE FEX MULTI-BAND CONDENSER

Four split-stator capacity ranges: 5 to 18.5 mmfds., 7 to 35 mmfds., 10 to 50 mmfds. and 19 to 120 mmfds. For 250 watt input final tanks. Net to amateurs. **\$15.00**

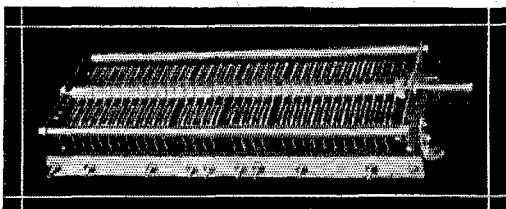

TYPE XE-160-70-XQ MULTI-BAND

Three split-stator capacity ranges: 9 to 34 mmfds., 13.5 to 83 mmfds. and 19 to 114 mmfds. For 250 watt input final amplifiers. Net to amateurs. **\$13.20**

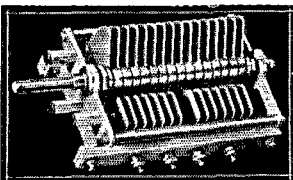

MIDWAY TYPE MT-70-GD

Typical light weight dual for medium power tanks of 100 watt input. .070" gap — G. E. mycalex insulation. Net to amateurs. **\$4.20**

DUAL TRIM-AIR MIDGET TRANSMITTING CONDENSER TYPE ET-30-AD

A sturdy and compact design for U.H.F. transmitters of medium power. .070" airgap — Isolanite insulation. Net to amateurs. **\$2.16**

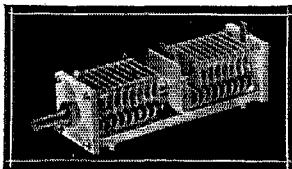

A reprint of a swell article on a "QRM DODGER" (stable E.C. osc. or "rubber crystal"), sent free on request. Got yours?

THE ALLEN D. CARDWELL MANUFACTURING CORPORATION
83 PROSPECT STREET, BROOKLYN, NEW YORK

sary. The 3.5-Mc: antenna in the rear of the station is center-fed. The other lines are for two-wire voltage feed systems. The rhombic antenna has a spaced (12") feed line designed for 800 ohms. Insulators for this were "manufactured" using two standard six-inch insulators end to end with a press fit into a short connecting sleeve, cemented with water-proof varnish. All feed lines are spaced as widely as possible vertically and horizontally on the cross arms of the poles to eliminate coupling between lines. The next month or so of experience with the directivity of the rhombic unterminated is being logged so that comparisons as exact as possible may be made with the same localities in following weeks when the 800 ohm termination at the far end has been added to absorb the power that would otherwise radiate eastward.

The diamond antenna is worth a separate paragraph. 1400 feet of wire (350 feet per leg) is a lot of antenna in any man's language. The angle between wires is 40° at the apex. It is "pointed" exactly east-west, the great circle direction to Los Angeles. According to "the book" we should get excellent power gain and horizontal directivity including 50° at a frequency as low as 3.5 Mc. while the coverage of the main lobe will take in 20° or more at the higher frequency . . . which means the whole of Oregon and California. On the bands where most amateurs operate the antenna should put a nice signal into every state west of the Mississippi River. A careful study of the characteristics (vertical and horizontal angle) of its use in practice we expect will enable us to use the antenna on different bands at the time best calculated for effectiveness in communication with western and midwestern members. An antenna relay makes it possible to use the directivity profitably many times in reception, where the ratio of strength between two signals on different antennas can be quickly tested to reduce interference and give a substantial boost to a weak signal, or enable the operator to choose the most favorable combination for any given reception problem.

SAFETY

As we turn back to the station and fall into a discussion of amateur radio matters generally we get to talking about the safety belt for outside work, and safety generally. The average amateur we fear has somewhat too little respect for his personal safety and that of his friends. In haste to get "results" safety is sacrificed, with lasting recriminations and regrets in some cases we know about.

W1AW is not only a model station in its two-way communication abilities and straightforward technique in construction and design. We expected it to have some special features not found in the usual amateur station to help in the very special programs it will conduct, and we were not disappointed. But W1AW is also a model for safety engineering! We're not talking about the overload relays in the power supplies that add to the high voltages and radio frequency power circuits.

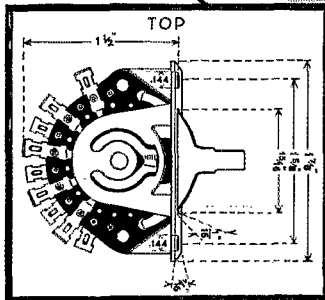
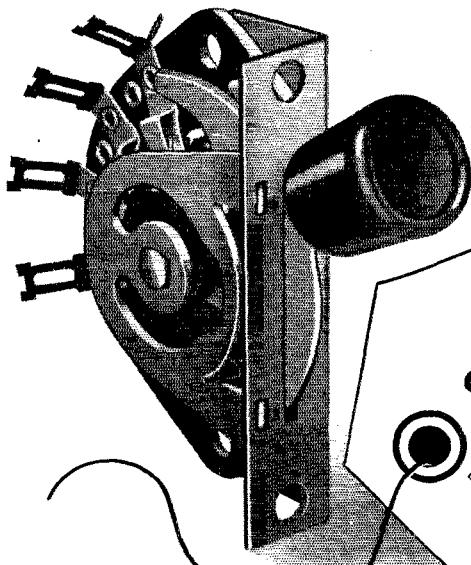

A space-saving lever action switch that can be furnished singly or assembled to an attractive mounting plate with any required number of switches in a group. Each switch will take up to 12 contacts that can be used in countless shorting or non-shorting sequences.

Contacts are of the long lived double wipe type. Centralab Lever Action Switches are furnished with either two or three positions. Index action can be positive in all positions, or spring return to center from either side.

for:

- **BROADCASTING** — In control panels for commercial and amateur transmitters.
- **RADIO RECEIVING** — Band changing, I.F. selectivity, sensitivity tone, and similar controls.
- **PUBLIC ADDRESS** — Centralized sound, intercommunicator, call systems.
- **TEST INSTRUMENTS** — Signal generators, analyzers, tube testers, multi-meters.
- **INDUSTRIAL USE** — Electronic apparatus, signalling devices, business machines.

... and any other application where multiple contact, low capacity switches are required to operate at low voltages and currents.

Send for specification sheet number 628 for further electrical and mechanical details

Centralab

DIVISION OF GLOBE UNION INC., MILWAUKEE, WISCONSIN

Say You Saw It in *QST* — It Identifies You and Helps *QST*

"The Name Tells the Story . . ."
The NEW Series 842-L
PRECISION
A.C.—D.C.—VOLT—OHM—DECIBEL
MILLIAMMETER—AMMETER
 with 2500 Volt A.C.—D.C. RANGE
 and 1000 M.A. and 10 AMP. RANGES



COMPLETE facilities for obtaining all measurement requirements for Service, Amateur, Laboratory, Industrial use. Master Rotary Switch permits speedy selection of all ranges. Large PRECISION 4½ inch square type meter with easy reading scales and large numerals. Shunts and multipliers are individually calibrated against laboratory standards to an accuracy within 1%. The base sensitivity of the meter movement, 400 microamperes, permits overlapping resistance ranges up to and including 10 megohms, and AC-DC voltage ranges at a sensitivity of 1000 ohms per volt.

842-L Size 7½ x 8½ x 4. Housed in walnut finished wood case with carrying handle. Less Batteries and Test Leads. Net. **\$21.95**

842-P Same specifications as 842-L but housed in walnut finished wood portable case with removable cover. Size 9 x 10 x 6. Less Batteries and Test Leads. Net. **\$23.95**

Ask for the new PRECISION catalog incorporating complete data on this popular unit, as well as all the other PRECISION ENGINEERED test instruments.

AVAILABLE AT LEADING DISTRIBUTORS

Following is a partial list

- | | |
|-------------------|-----------------------------|
| All branches | WHOLESALE RADIO SERVICE CO. |
| Baltimore, Md. | RADIO ELECTRIC SERVICE CO. |
| Boston, Mass. | THE RADIO SHACK |
| Buffalo, N. Y. | RADIO EQUIPMENT CORP. |
| Chicago, Ill. | NEWARK ELECTRIC COMPANY |
| Columbia, S. C. | DIXIE RADIO CO. |
| Dallas, Texas | SOUTHWEST RADIO SUPPLY |
| Des Moines, Iowa | H. E. SORENSON CO. |
| Detroit, Mich. | DUFFY-SERLIN RADIO CO. |
| Hazleton, Pa. | ROBERT A. SYLVESTER |
| Houston, Texas | STRAUSS-FRANK CO. |
| Los Angeles, Cal. | KIERULFF & CO. |
| New York, N. Y. | TERMINAL RADIO CORP. |
| Norfolk, Va. | RADIO SUPPLY CO. |
| Portsville, Pa. | JONES RADIO CO. |
| Reading, Pa. | GEORGE D. BARBEY CO. |
| Rochester, N. Y. | RADIO PARTS & EQUIPMENT CO. |
| Seattle, Wash. | NORTHERN RADIO CO. |
| Tacoma, Wash. | A. T. STEWART CO. |
| Texarkana Ark. | MIMS RADIO CO. |

PRECISION
APPARATUS CORPORATION
 821 EAST NEW YORK AVE., BROOKLYN, N. Y.
 EXPORT DIVISION—458 BROADWAY, NEW YORK
 Cable Address: "Morhanex"

The "safety" story is worth telling too and we hope that you will use any *one*, or *all* the measures in your own shacks, to improve on some of the situations we have seen. We have personally added an inexpensive electric warning sign to our own "heap." "Familiarity breeds contempt." We find it advisable, then, to keep the idea of safety constantly before us.

The safety features of WIAW, in brief: (1) Interlock switches. In series with 110-220 volt power, "kill" the transmitters instantly, if a dust cover door is opened in the rear of any unit. (2) The lattice—prevents "burning curiosity" from burning fingers. (3) Grounding antennas, accomplished by plug jacks, protects from lightning—fire hazard—and grounding metal frames of the sets—putting meters in B minus (no metal cased meters) completes the job. (4) The danger sign, within *each* unit automatically warns the operator to be ever watchful—as well as showing if fuses have been removed on either side of the power circuit. These signs are turned *on* by an interlock at the same time the *power* is turned *off*.

A Low-Cost Single-Signal Receiver

(Continued from page 18)

monics fall on broadcast carriers of the proper frequency, *i.e.*, 910 and 1360 kc., in round numbers. The i.f. does not have to be exact; anything between 450 and 460 will be satisfactory. With the beat oscillator serving as a test oscillator, the alignment procedure will be the same as before, but adjustment of signal level will not be so convenient.

ADJUSTING R.F. CIRCUITS

After the i.f. is aligned, the next step is to get the r.f. end working. No special equipment is needed for this purpose. Plug in a set of coils for some band on which there is a good deal of activity—7 Mc. in the evening, for instance. Set the oscillator padding condenser, C_2 , at approximately the right capacity; with the coil specifications given, the proportion of total C_2 capacity on each band will be about as follows: 1.75 Mc., 80 per cent; 3.5 Mc., 75 per cent; 7 Mc., 95 per cent; 14 Mc., 90 per cent; 28 Mc., 45 per cent. Now set the mixer regeneration control, R_2 , for minimum regeneration—all the resistance in circuit. Connect an antenna and set C_4 at maximum capacity. Switch the beat oscillator on by turning C_{20} out of the maximum position, and adjust the screw on T_3 until the characteristic beat-oscillator hiss is heard.

Now tune C_1 slowly over its scale, starting from maximum capacity. Using the 7-Mc. coils as an example, when C_1 is at about half scale there should be a definite increase in noise, and in the strength of the signals which no doubt by this time have already been heard. Continue on past this point until a second peak is reached on C_1 ; at this peak the input circuit is tuned to the frequency which represents an image in normal reception. The oscillator in the receiver is designed

New UH35

An ultra high frequency tube with the lowest inter-electrode capacity of any transmitter tube available today.

Filament voltage5 volts
 Filament current.....4 amps.
 Amplification factor30
 Grid-plate capacity 1.6 mmfd
 Grid-filament cap. 1.9 mmfd
 Max. plate voltage 1500 volts
 Max. plate current
 150 milliamperes
 Plate dissipation.....35 watts

List price NET \$10

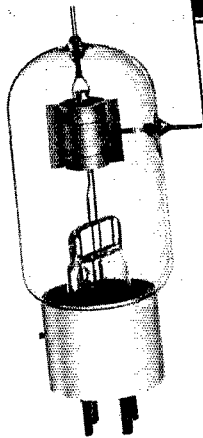

New TWIN TRIODE

A small tube with two plates, two grids and a common filament possessing unusual power capabilities at all frequencies. Capable of a power output of 15 watts at 300 megacycles. A 6 volt filament, that can be operated from a storage battery, makes this tube particularly adaptable for portable equipment where a high order of power output is desired. A quick heating filament, which permits simultaneous application of plate and filament power, conserves power. Can be operated in class "B" audio and is very desirable for aircraft transmitters.

Filament voltage6 volts
 Filament current.....4 amps.
 Amplification factor37
 Max. plate voltage 1500 volts

Characteristics per section
 Grid-plate capacity.....2 mmfd
 Grid-filament cap. 1.9 mmfd
 Max. plate current.....85 mills
 Plate dissipation.....35 watts

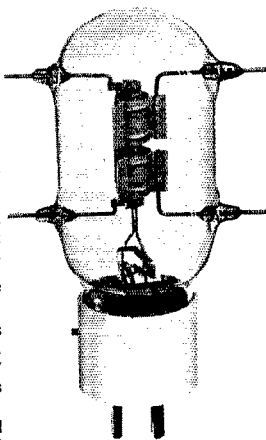

List price NET....\$13.50

New UH50

Directly interchangeable with certain conventional tubes now on the market. Eimac specially processed tantalum plates and grids assure you of vastly superior performance.

Filament voltage.....7.5 volts
 Filament current..3.25 amps.
 Amplification factor.....10.6
 Grid-plate capacity 2.6 mmfd
 Grid-filament cap. 2.2 mmfd
 Max. plate voltage 1250 volts
 Max. plate current
 125 milliamperes
 Plate dissipation.....50 watts

List price NET....\$12.50

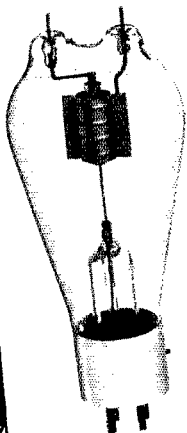

5 steps ahead in ULTRA HIGH FREQUENCIES

Eimac
 TUBES

New UH51

A great improvement over conventional tube types. The use of a rugged Eimac filament permits higher power operation and greatly reduces inter-electrode capacities.

Filament voltage5 volts
 Filament current6.5 amps.
 Amplification factor.....10.6
 Grid-plate capacity 2.3 mmfd
 Grid-filament cap. 2.2 mmfd
 Max. plate voltage 2000 volts
 Max. plate current
 175 milliamperes
 Plate dissipation.....50 watts

List price NET....\$12.50

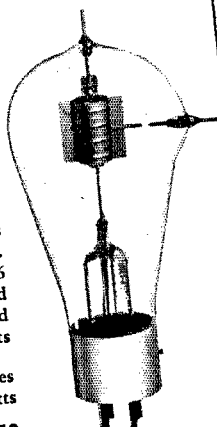

1000UHF

The highest power high frequency triode available on the market today. A pair of 1000UHF tubes are capable of a power output of approximately 2 kilowatts at 100 megacycles. Due to its small physical size (1 1/2 in. overall height) it is necessary to cool the bulb and seals with forced air while it is in operation.

Filament voltage7.5 volts
 Filament current.....16 amps.
 Amplification factor30
 Grid-plate capacity 4.5 mmfd
 Grid-filament cap.6 mmfd
 Max. plate voltage 6000 volts
 Maximum plate current
750 milliamperes
 Plate dissipation.....1000 watts

List price NET \$175

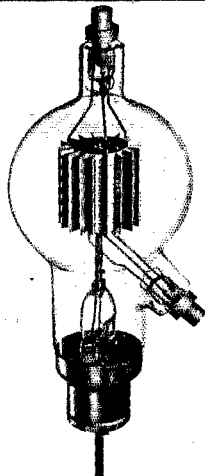

EITEL McCULLOUGH, Inc.
 SAN BRUNO, CALIFORNIA

NEW

OHMITE

Vacuum-Type

DUMMY ANTENNA

Resistor

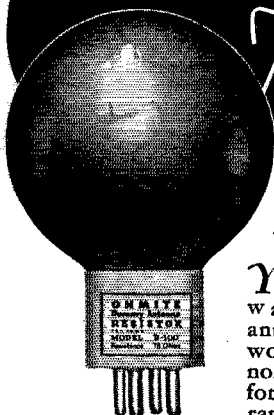

Patents Pending

**MODEL D-100
100 WATTS**

YOU'VE always wanted a dummy antenna resistor that would be practically non-inductive, suitable for use over a wide range of radio frequen-

cies, and have nearly constant resistance at various loads. Now you have it in the new Ohmite Model D-100 "Vacuum-Type" Dummy Antenna Resistor.

1. Built like a vacuum-tube. Power easily determined from R.F. ammeter reading.
2. Mounts in standard tube socket.
3. 73 ohm value — to simulate concentric and twisted pair lines.
4. 100 watt rating. Easily combined in series, parallel and series-parallel groups for increased power capacity or other required resistances.

You need an efficient, dependable Dummy Antenna to check your power and insure peak efficiency from your rig — to avoid interference when tuning and relieve ham band congestion. The new Ohmite Model D-100 lists at.....**\$5.50**

Ask Your Jobber or Write for D-100 Dummy Antenna Data

OHMITE MANUFACTURING CO.
4831 West Floumoy Street Chicago, Illinois, U. S. A.

OHMITE

RHEOSTATS RESISTORS TAP SWITCHES

to work on the high-frequency side of the incoming signal, so that C_1 always should be tuned to the peak which occurs with most capacity. On the higher-frequency bands the two peaks will be closer together on C_1 because of the greater tuning range; the reverse is true on the lower frequencies, and on 160 meters the two peaks will be found at opposite ends of the tuning range.

After the signal peak on C_1 has been identified, tune C_2 over its whole range, following with C_1 to keep the mixer circuit in tune, to see how the band fits the dial. With C_2 properly set, the band edges should fall the same number of main dial divisions from 0 and 100; if the band runs off the low-frequency edge, less capacity is needed at C_2 , while the converse is true if the band runs off the high edge. Once the band is properly centered on the dial, the panel may be marked at the appropriate point so that C_2 may be reset readily when changing bands. Incidentally, if the type of knob shown in the photograph is used it will be helpful to scratch a thin line on the edge of the knob opposite the pointer arrow so that the scratch may be lined up with the mark on the panel. The scratch may be filled in with white ink or paint for easy visibility.

MIXER REGENERATION

At this point it is time to become familiar with the operation of the mixer when regeneration is introduced. Tune in a signal and adjust C_1 for maximum response. Advance R_2 slowly, simultaneously swinging C_1 back and forth through resonance. As regeneration is increased signals and noise both will become louder and C_1 will tune more sharply, until finally the mixer circuit will break into oscillation when, with C_1 right at resonance, a loud carrier will be heard, since the oscillations generated will go through the receiver in exactly the same way as a signal. Always work the mixer somewhat below the critical regeneration point and never permit it to oscillate in practical operation.

The procedure described above should be followed through for all coil sets. Barring mistakes in wiring or changes in circuit constants, particularly coil dimensions and tuning capacities, the only feature likely to give trouble is the regeneration. If the antenna happens to be nearly resonant in the band, it may not be possible to make the mixer oscillate; on the other hand if the antenna loading is negligible the circuit may oscillate continuously regardless of the setting of the regeneration control. The former condition can be cured by reducing the capacity of C_4 or by increasing the number of turns on L_3 . If the mixer oscillates continuously, the opposite remedies are required. The latter condition easily can be recognized by a series of beats and chirps as C_1 is tuned over its range. Normally, only signals tuned in by the oscillator circuit will be heard, with C_1 having no effect except to control volume. Since the antenna loading changes with frequency, there may be cases where the mixer will go into oscillation at frequencies somewhat

GET READY FOR THE COMING SEASON!

Rebuild with
PA-300 · BD-40 · OD-10

NOW is the time to rebuild and modernize your transmitter. Vacations are over, and most of us are thinking about firing up the old rig, and getting it into shape for the coming season. If you are rebuilding or redesigning your present transmitter, you can save yourself a lot of time and hard work by using the new Hammarlund Foundation Units. Illustrated are three complete stages, which when combined, make up a transmitter ranging in power output from 100 to 300 watts, depending upon the type of tubes used in the output stage.

"OD-10" is a crystal oscillator-doubler, "BD-40" is a buffer-doubler, and the "PA-300" is a push-pull final amplifier. Each kit consists of all necessary brackets, screws, nuts, lockwashers, and instructions. These units eliminate the usual chassis and the necessary drilling and machining. Units bolt directly to the front panel. Due to the compact arrangement of parts, all leads are short and direct, resulting in a high degree of efficiency and stability.

Don't waste months of valuable time working out the difficult details of transmitter design. Build the modern way, and spend more time on the air this fall and winter. Write Dept. Q-10 for illustrated folder.



HAMMARLUND MANUFACTURING CO., INC.
424-438 West 33rd Street, New York City

Canadian Office
424 WEST AVE. NO., HAMILTON, ONTARIO

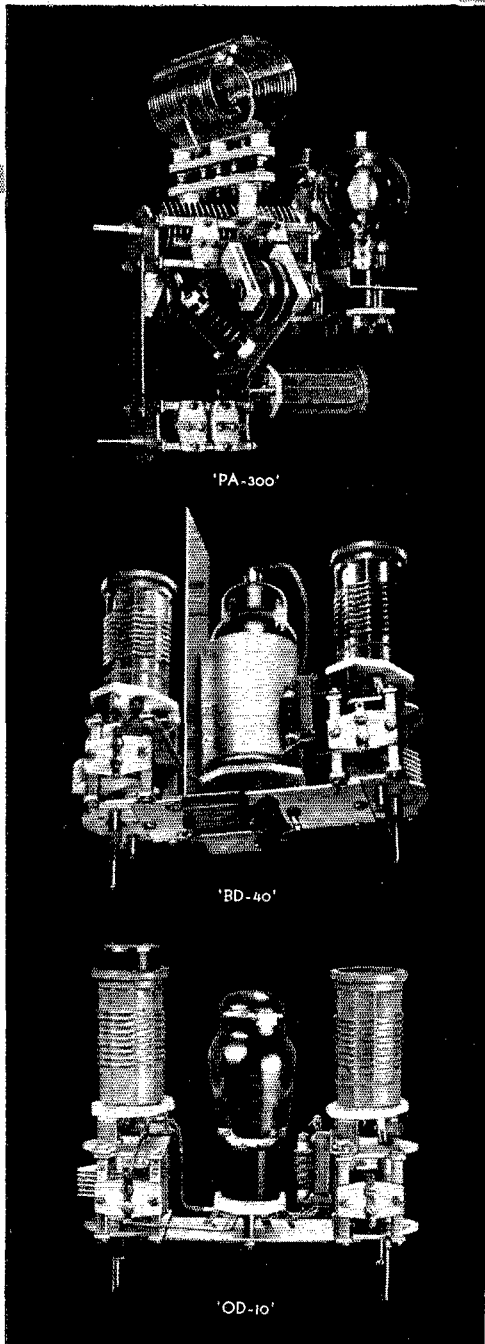

Say You Saw It in *QST* — It Identifies You and Helps *QST*

NEW NATURAL VOICE DYNAMIC MICROPHONE

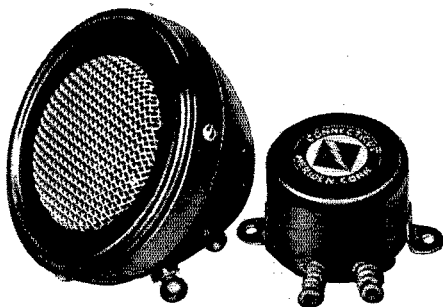

DESK-HAND MODEL 2660-W WITH 8 FT. CABLE

- RANGE
- SENSITIVITY
- SEPARATE TRANSFORMER TO MATCH GRID INCLUDED
- NO CRYSTAL TO BREAK
- NOT AFFECTED BY HEAT
- NO CARBON TO PACK
- FITS IN PALM OF HAND (or sits on desk)
- RUGGED CONSTRUCTION

List Price \$10.00

Subject to regular discounts

Manufactured by

CONNECTICUT Telephone & Electric CORP.

MERIDEN, CONN., U. S. A.

For over forty years originators and makers of
fine communicating equipment

Ask your dealer to stock this

INTRODUCTORY ORDER BLANK

Mail with remittance to
Connecticut Tel. & Elec. Corp.,
Meriden, Conn., U. S. A.

Enclosed find money order for \$.....
for which send me..... Dynamic Mi-
crophone with Transformer at \$6.00
prepaid for each combination.

Name.....

Address.....

City.....State.....

removed from the actual signal frequency, but operate normally at the latter. In general, it is not necessary to "push" the regeneration for the sake of signal strength. It is there chiefly to increase the signal-to-image ratio, which it does by the process of building up the desired signal. Peak regeneration is needed only when a desired signal is being QRM'd by an image, which happens a surprisingly small number of times in practice.

It is a good plan to spend some time operating the set without attempting to add regeneration to the i.f. stage, in order to attain complete familiarity with the method of handling mixer tuning and regeneration. As a straight super the receiver is, of course, considerably more selective than a t.r.f. receiver, especially to strong off-channel signals. Learn to keep C_1 always at resonance or on the low-frequency side of resonance with the incoming signal. Keeping exactly in line naturally requires "two-handed" tuning, but in practice it will be found that C_1 need not be touched when tuning over the portion of the band normally covered near the transmitter frequency. This condenser may, in fact, be used as a volume control, in which case it is advisable to keep it on the high-capacity side of resonance so that it will be as far as possible from resonance with the image frequency. Its tuning will not be too critical so long as the regeneration is kept to a moderate value; at peak regeneration, however, the tuning is quite sharp. For operating convenience, be sure to pick out an easy-running condenser for C_1 —there's no band-spread on this circuit.

The oscillator-mixer coupling condenser, C_5 , should be adjusted so that pulling of the oscillator frequency at 14 Mc. is negligible as C_1 is tuned through resonance with the incoming signal. The setting generally will be with the plates rather far apart. There will always be considerable pulling if C_1 is tuned to the oscillator frequency, even on the low-frequency bands. This, however, does not represent an actual operating condition. On 7 Mc. and lower there should be no detectable change in beat note as C_1 goes through the signal peak. A few hundred cycles change is typical of 14 Mc.

I.F. REGENERATION

When the operation of the receiver is completely familiar, the i.f. regeneration may be added. The method has already been mentioned; it remains only to describe the operation. The amount of feed-back will be determined by the length of wire inserted in the can containing T_2 . Optimum selectivity usually will be secured when the regenerative coupling is adjusted so that the 6K7 goes into oscillation with the gain control, R_4 , fairly well "down"—far enough so that it is well below maximum gain and in the region where, without regeneration, its effect on gain is not great. There are two reasons for operation in this way rather than with the feed-back adjusted so that oscillation takes place when the gain is near maximum. In the first place, the normal tube gain is not needed—the volume will be too great

SELECT YOUR CRYSTAL

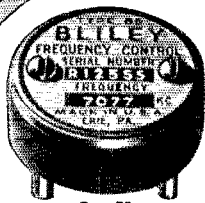

Type B5
20-Meters, \$7.50
40-Meters, \$4.80

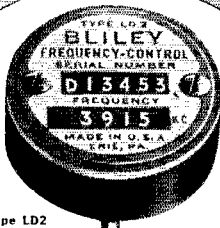

Type LD2
80-160-Meters, \$4.80

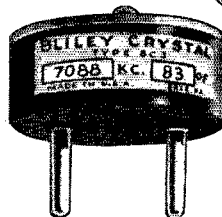

Type BC3
40-80-160-Meters, \$3.35

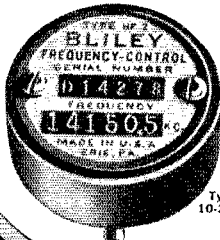

Type HF2
10-20-Meters
\$5.75

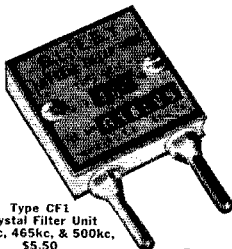

Type CF1
Crystal Filter Unit
456kc, 465kc, & 500kc.
\$5.50
1600kc. I. F., \$9.50

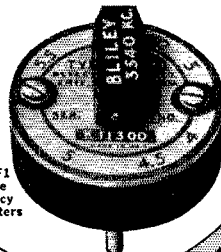

Type VF1
Variable
Frequency
40-80-Meters
\$7.50

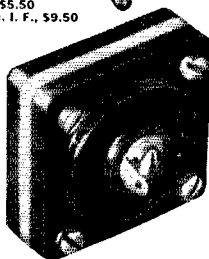

Type SMC100
Crystal Calibrator Unit, \$7.75

FROM THE

COMPLETE BLILEY LINE

Whatever may be your interests in amateur radio from 5 through 160-meters, there is at least one type of Bliley Crystal Unit which will increase your operating pleasure. Precise engineering, careful design, painstaking manufacture and accurate calibration all go together to insure long life and trouble-free performance.

In keeping with technical progress, Bliley has just added three new units with outstanding characteristics. The popular priced medium-drift BC3 unit is now available for the 160-meter band. Variable frequency crystals, made practical by the VFI 80-meter crystal unit, are now manufactured for the 40-meter band. For checking the calibration of radio receivers, test oscillators and frequency monitors, the type SMC100 dual frequency crystal unit (100kc.-1000kc.), brings accurate frequency measurements within the scope of every amateur.

For complete information on all Bliley Crystal Units, see your distributor today. Bliley Electric Company, Erie, Pa.

BLILEY CRYSTAL UNITS

GROSS PRESENTS

THREE WINNERS

CB-55 CB-150 CB-250

Fine Radiophone transmitters selling at amazingly low prices

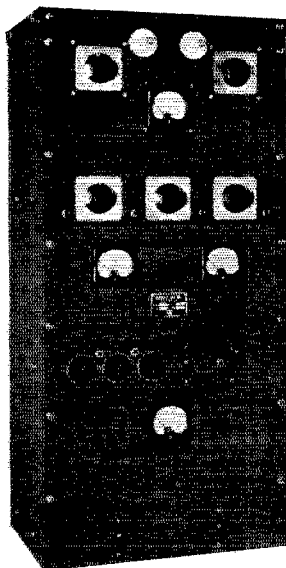

Gross CB-150

Input — 150 watts

Coils available for 30, 14, 7, 3.5, and 1.7 mc

Class B modulation

All the very latest type tubes used throughout

Completely self contained from mike jack to antenna tuning unit

Descriptive Bulletins on Request

CB-55 POWER 95 WATTS

CB-250 POWER 250 WATTS

"THE STANDBY" (2 to 2000 Meters) 3 TUBE A.C. AND D.C. RECEIVER

The Standby was designed to supply a need for a receiver to cover all the amateur broadcast and commercial frequencies (2 to 2000 meters). It will fill the requirements for an all round "Standby" receiver. Super regeneration is used from 2 to 15 meters and straight regeneration on the higher wavelengths up to 2000 meters. Loud speaker reception is possible on most stations.

- Power supply incorporated. ● Individual antenna tuning for high and low wave ranges. ● 1-76 super regenerative detector, 1-6J7 regenerative detector, 1-12A7 audio amp. and rectifier.

BULLETIN ON REQUEST

Complete kit of parts less coils, tubes, cab.	\$7.59
2-5-10 meter coils (set of 3)95
94 to 15 meter coil39
15-200 meter coils (set of 4)	1.30
200-310 meter coil39
310-550 meter coil36
550-1050 meter coil60
1000-2000 meter coil60
Metal cabinet	1.50
Kit of three tubes	2.40
Wired and tested in our lab., additional	2.00

GROSS RADIO, INC.

51 VESEY STREET

NEW YORK

Cable Address: GROSSINC

with both regeneration and high tube gain. Second, the selectivity will be considerably greater if the signals are kept at a low level and built up to a peak almost solely through the use of regeneration. Aim to balance gain and regeneration so that the average signal level, at resonance with peak regeneration, is about the same as with normal i.f. gain without regeneration. The off-resonance signals will then be rather far down, giving greater effective selectivity. With the conditions recommended, the i.f. regeneration gives a voltage gain of about 40 on a moderately strong signal; that is, the signal is 40 times as strong with regeneration as without it at the same i.f. gain-control setting.

For single-signal c.w. reception, set the beat oscillator so that when R_4 is advanced to make the i.f. just go into oscillation the resulting tone is the desired beat-note frequency. Then back off on R_4 to give the desired selectivity. Maximum selectivity, of course, will be secured with the i.f. just below the oscillating point; noise and miscellaneous clicks and impulses will make a "ringing" sound at this point and the signal must be tuned carefully to be set right on the peak. At the peak the signal strength will build up to a large value as compared with a frequency slightly off resonance. With regeneration reduced slightly the ringing will disappear and the signal peak will not be quite so marked, although the selectivity still will be high. The "other side of zero beat" will be very much weaker than the desired side. A typical measurement, using a 1000-cycle beat note, gave a ratio of 35 db between the desired signal and the a.f. image, or 1000-cycle beat note on the "other side." The ratio will depend somewhat on the accuracy of i.f. tuning; the best method found is to peak all i.f. circuits as accurately as possible without regeneration, then to introduce the regeneration without further adjustment of the i.f. trimmers.

Since the i.f. amplifier works out of the mixer, it is to be expected that the latter will have some effect on the i.f. regeneration, and such is the case if the regeneration is worked too near the critical point. For example, if C_1 is slightly on the low-frequency side of resonance and R_4 is advanced to critical regeneration, tuning the mixer input to the high-frequency side may cause the i.f. amplifier just to go into oscillation. To overcome this, R_4 may be set so that the i.f. does not oscillate at any setting of C_1 ; this will give somewhat less than maximum selectivity, but there is still plenty. Another method is to detune slightly the i.f. circuit in the plate of the 6L7, which will "decouple" the circuits sufficiently to make the i.f. regeneration independent of the setting of C_1 . This, however, has an adverse effect on the selectivity because of the staggered tuning.

A regenerative i.f. stage has a quite sharp peak when operated as outlined above. Although the attenuation at frequencies several kilocycles from resonance is not as good as with a crystal filter, the overall selectivity, plus the peak, gives a highly satisfactory single-signal effect—certainly one decidedly worth while not only for c.w. but also for 'phone work. On 'phone, the sidebands are

OUT FRONT

The merit of these excellent triodes has been established by performance as evidenced by the several hundred testimonial letters received from satisfied users

HY 25 \$1.45

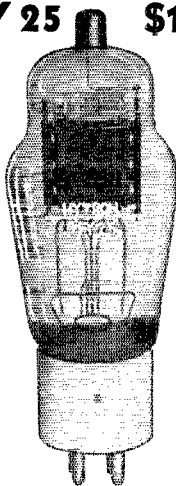

Fil. 7.5 volts. 2.25 amps. Plate volts 800 max. Plate dissip. 25 watts max.

Ceramic Base and Insulation

HY 40 \$2.75

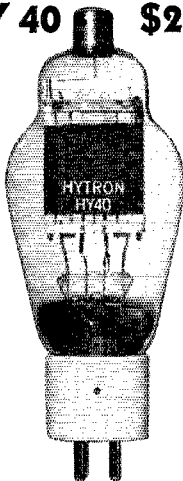

Fil. 7.5 volts. 2.25 amps. Plate volts. 1000 max. Plate dissip. 40 watts max.

*Graphite Anode, Lava Insulation
Ceramic Base*

HY 51A \$5.00

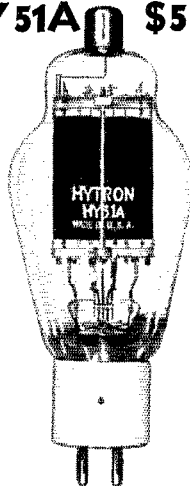

Fil. 7.5 volts. 3.5 amps. Plate volts 1000 max. Plate dissip. 65 watts max.

*Graphite Anode, Lava Insulation
Ceramic Base*

OTHER POPULAR TYPES

HY 57 TRIODE **\$3.50**

HY 60 TETRODE **\$2.50**

HY 61 TETRODE **\$3.00**

HY 615

U.H.F. OSCILLATOR
R.F. AMP. DET.

\$2.00

6L6GX TETRODE **\$1.55**

866 JR. MER. RECT. **\$1.05**

866 MER. RECT. **\$1.50**



HYTRONIC

SALEM

LABORATORIES

MASS.

A DIVISION OF THE HYTRON CORP.

YOUR COPY IS READY

52 PAGES
OF VITAL INFORMATION EVERY RADIO-
TELEGRAPHER HAS
BEEN WAITING FOR

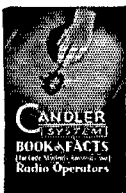

NEW EDITION

IT'S FREE GET YOURS TODAY

Whether you are trying for your license, any grade, or just learning code, here is the answer to all your questions. Contains new F. C. C. rules and regulations, examination questions and answers, valuable advice by leading authorities on how to pass your examinations, etc. World's fastest operators give you speed tips. It took a lifetime to acquire the facts now available for



You'll find his experiences interesting readings . . . and a valuable aid to mastering code and acquiring professional technique. Read what McElroy, World's Code Champion, has to say about gaining speed.

L. R. McDonald, W8CW—
Winner Code Contest, A.R.R.L.
Detroit Convention, Sept. 6, 1937.
Copied 60 wpm. without error.
"Practice alone will not develop
a fast op. Code is a mental process.
Candler's Exclusive Mind Training
is essential to fast code. And
Candler knows the short cuts!"

WRITE FOR YOUR
FREE BOOK NOW!

CANDLER SYSTEM CO.
DEPT. Q-10, ASHEVILLE, NO. CAROLINA, U. S. A.

the first time in this free book. To every man interested in radio as a career, this information is essential.

If radio is your hobby, by all means take advantage of this opportunity to add countless hours to your enjoyment.

CANDLER
Has Trained Over
25,000 Operators



drastically cut of course, but it becomes possible to copy signals which otherwise would be completely drowned out by near-by carriers.

The operating characteristics of the receiver have been given detailed attention because in any receiver involving regeneration the success of the outfit is chiefly attributable to the skill of the operator. It takes a little time to learn how to get the most out of such a set, but the results are there to be had if a little patience is expended in finding out how to get them. Do one thing at a time and find out all about it before going on to the next. You'll be surprised at what can be done. And incidentally, in a speaker-blasting contest, this outfit will shout just as loudly as anything else having a pentode output stage.

A Six-Band Kilowatt Transmitter

(Continued from page 31)

frequency range will be because of too-high minimum capacity. Also, the condensers should have at least the spacing indicated in Fig. 1, because the r.f. voltage across each circuit is high.

Proper placement of by-pass condensers is of utmost importance. Remember this transmitter is capacitively-coupled to the final amplifier, which makes the plate coil of each stage of the exciter the "grid" coil of the final amplifier, so that by-pass condensers of each stage must terminate at the filament circuit of the final amplifier.

Experience with this transmitter and others leads us to believe that very few push-pull amplifiers are properly balanced with regard to grid current. Few, if any, difficulties have been experienced in obtaining balance in the plate circuit, but the grid circuit is another story. The assumption that the mechanical center-tap of the grid coil or grid circuit is the electrical center-tap is far from the truth. A simple method of checking the balance of a push-pull amplifier is to take one tube out of the socket and then, with the plate lead disconnected, check the grid current to the remaining tube. Remove the tube from the socket and place the same tube on the other side of the circuit. Again check the grid current. Adjust the center tap connection a quarter inch at a time until balance is found. The same procedure should be applied to each stage of the exciter unit. Sometimes the filament by-pass return from the grid circuit must be adjusted for exact electrical symmetry between the two tubes. The grid leads can be made mechanically symmetrical around the center of the coil.

The exciter is capable of supplying to the final tubes a grid current of at least 100 ma. through a 2000-ohm grid leak. The bias voltage and grid current are more than adequate for plate modulation of the final. If some fixed bias voltage is desired in order to key one of the lower powered stages, it is recommended that the smallest bias which will give plate-current cut-off with no excitation be employed. Contrary to popular belief, a large amount of fixed bias is not a safety



HAYWIRE versus CHROME PLATE

WE all admire the resourceful ham who can get anything from a balky mule to a 5 meter job working with a piece of haywire placed just where it is needed.

There are stations dotting the globe which are chock full of ingenious gadgets and ideas, yet which always appear to be "half finished." Don't belittle them. More than likely they have an alert owner who is always trying something new. He probably has a fat stack of QSL cards tucked away somewhere.

However, most all of us like to "doll up" our handiwork like a commercial job. If this can be done without losing flexibility, there are many advantages.

1. More stable operation.
2. Less fire hazard.
3. Less danger of a "High Voltage Manicure."
4. It will impress the neighbors a lot more.

We have a nice little unit that will help in that direction. It is a flat wire-wound resistor, molded in bakelite, and is called our M-1034 Bleeder. It has 25,000 ohms over-all resistance with taps at 7,500, 10,000, 12,500 and 15,000 ohms. The rating is 13 watts when mounted flat against a metal chassis, somewhat less on a wood base-board, and 9 watts in free air. The metal chassis helps to radiate the heat. The maximum current in any section should not exceed 28 milliamps. These ratings are based on a 100°C. temperature rise. The mounting bracket attached to the resistor holds it securely and the soldering lugs offer a convenient tie for bypass condensers and wiring. Its virtues are obvious as a bleeder and bias resistor

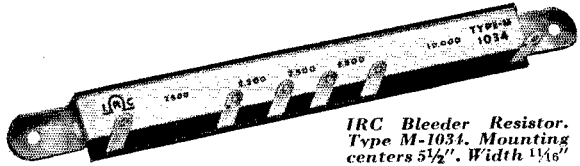

IRC Bleeder Resistor.
Type M-1034. Mounting
centers 5 1/2". Width 1 1/8"

for a receiver or transmitter power supply up to 500 volts.

Since $I = E/R$ and $Watts = E^2/R$, the bleeder current and dissipation, due to the bleeder current, are $I = E/25,000$, etc., as follows:

D.C. Volts	Bleeder Current-Amps.	Watts
200	.008	1.6
250	.010	2.5
300	.012	3.6
350	.014	4.9
400	.016	6.4
450	.018	8.1
500	.020	10.0

To determine which tap to use for bias voltages is easy. Let's take an example — say a 400 volt supply with a tap to give 250 volts at 2 1/2 milliamps.

The bleeder, by itself, draws (from the table above) .016 amps. See diagram "A" below. The tap draws .0025 amps. so the total current in the top section of the bleeder is $.016 + .0025 = .0185$ amps. See diagram "B." The voltage drop across the bottom section is 250 volts so the voltage across the top section must be $400 - 250 = 150$ volts.

Now, the resistance of the lower section should be $R = E/I = 250/.016 = 15,600$ ohms. The resistance of the upper section should be $150/.0185 = 8,100$ ohms. Since these values are not critical you can use the nearest tap, which will be 15,000 ohms. The same procedure is followed in figuring for other values of bias voltage and current.

Where neatness and compactness are important these M-1034's should be

useful. In high quality speech amplifiers and Government equipment you will find them alongside of their "big brothers," the IRC Cement Coated Resistors.

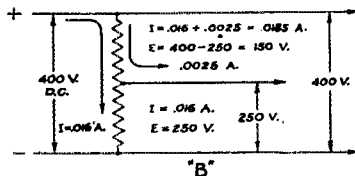
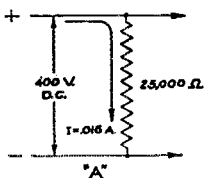

INTERNATIONAL RESISTANCE COMPANY • 401 NORTH BROAD STREET, PHILADELPHIA, PA.

ENJOY your QSO's with the tried and tested TYPE HFM PORTABLE OR FIXED CRYSTAL CONTROLLED TRANSMITTER

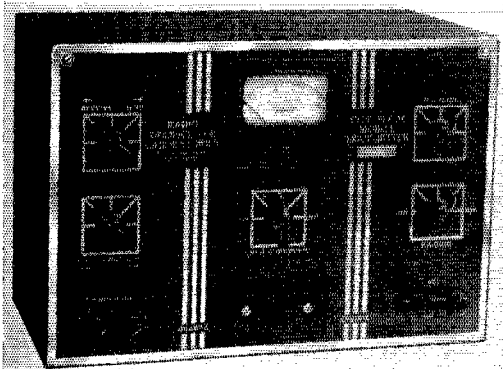

A fine transmitter for home, car or emergency. 1715-60,000 Kc. CW — Phone — MCW. 20 to 36 watts input to final with 300 to 425 volts.
Price **\$57.50**

the new POPULAR PRICED MULTI-BAND FIELD STRENGTH METER

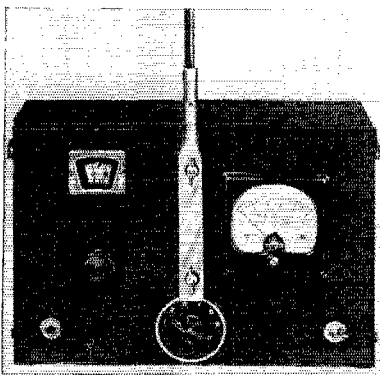

Adjustment of transmitter and antenna output is largely guesswork without a good field strength meter. 1715-60,000 Kc. Six band switch. Phone monitor. Price **\$18.50**

Radio Transceiver Laboratories
8627 115 Street Richmond Hill, New York City

factor for your tubes but is rather a hazard. The reason for this statement is that often during the adjustment or operation of the equipment the grid structure may become overheated because of excessive grid current or perhaps by a sudden flare-up of the anode caused by some misadjustment. The grid can very easily be heated to incandescence or to the point of actual primary emission. If all fixed bias is used, the filament can very easily be destroyed because the filament is highly positive with respect to the grid and the electrons released from the hot grid will overheat and destroy the filament in much the same manner that the electrons from the filament bombard the plate. A minimum of fixed bias coupled with some grid leak will aid greatly in overcoming this hazard.

The transmitter is constructed on a standard iron chassis 10 by 23 by 3 inches, and the panel is of 3/32-inch dural, 7 by 23 inches. The various parts carrying r.f. are isolated from the chassis by small Isolantite insulators. All of the r.f. is above deck, while the supply circuits are underneath the chassis. Two meters are used to measure current in all grid and plate circuits. The use of separate filament transformers makes the meters "cold" so far as voltage is concerned, and also makes possible a simple switching arrangement. One meter is connected in the final negative lead at all times.

Operation is quite straightforward and is entirely conventional. There need be only the flick of a switch to select the proper crystal. The three-position band-selector switch is adjusted for either 1.75-3.5-Mc. operation, 7-14-Mc. operation or 28-56-Mc. operation. Five-meter operation will require changing the coil in the second frequency-multiplying stage. The various tank circuits are adjusted for resonance at the desired frequency after selecting the proper final tank circuit. A quarter-wave line makes an efficient tank for the final on 56 Mc. The line can be rolled up to occupy little more space than the ordinary tank coil. No tuning capacity is necessary when such a tank is used.

A valuable addition to the transmitter is an auto-transformer capable of giving half voltage to the primary of the plate power transformer during the tuning-up operation. An additional refinement would be to have a small neon bulb permanently connected to a small pickup coil adjacent to each tank of the exciter stage. Such an arrangement would make unnecessary the use of the milliammeter as a tuning indicator, since after approximate resonance is found by means of the bulb, exact resonance can be determined by tuning for least visible dissipation on the 35T plates.

The transmitter has been in constant use since it has been completed and the results have been more than gratifying. In order to obtain all-band operation a long single-wire antenna has been used against ground, but undoubtedly superior performance on any one band could be obtained with an antenna primarily designed for that frequency. Even so, WAC has been made numerous times with this "midget kilowatt."

MEISSNER SIGNAL SHIFTER

A VARIABLE FREQUENCY EXCITER UNIT FOR REMOTE OPERATION

Offers convenience and utility for the amateur. An electron-coupled exciter unit that has excellent frequency stability. It's variable — you can cover any amateur band right from your operating position. For remote control — there's plenty of excitation available. Hundreds already in operation in "ham shacks" from coast to coast.

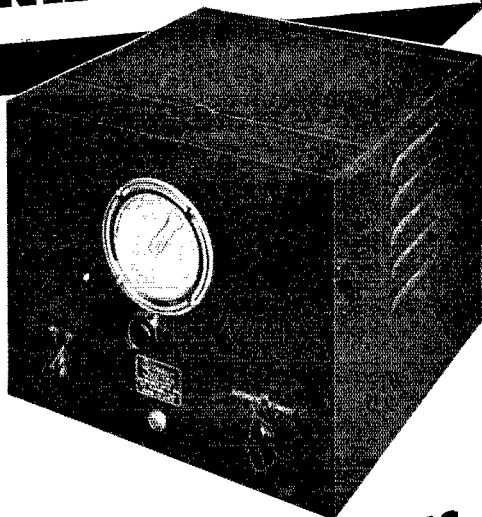

IT REALLY WORKS!

NEW!



The SIGNAL SHIFTER is completely assembled, wired and adjusted. It is ready for use (except for tubes) when you buy it. Ask your PARTS JOBBER for a demonstration. Net Price \$39.95.

120-PAGE COMPLETE INSTRUCTION BOOK

Detailed wiring instructions! Pictorial Diagrams! Schematics! Alignment Data! Constructional data and operation instructions on 15 of the new Meissner receiver kits; also adapters and converters.

Your PARTS JOBBER sells them for only 50¢ — or order direct from the factory. Address Dept. Q-10.

Meissner

MT. CARMEL, ILLINOIS

"A FAMOUS NAME FOR TWO DECADES"



NOW
this high-powered radio engineering library

sent to you for 10 days' trial —
 at a special price and terms

These books cover circuit phenomena, tube theory, networks, measurements, and other subjects — give specialized treatment of all fields of practical design and application. They are books of recognized position in the literature — books you will refer to and be referred to often. If you are a researcher or experimenter — if your interest in radio is deep-set and based on a real desire to go further in this field — you want these books for the help they give in hundreds of problems throughout the whole field of radio engineering.

RADIO ENGINEERING LIBRARY

— especially selected by radio specialists of McGraw-Hill publications
 — to give most complete, dependable coverage of facts needed by all whose fields are grounded on radio fundamentals

For home-study and reference. Contains a revised selection of books culled from latest McGraw-Hill publications in the radio field.

5 volumes, 3064 pp., 2000 illustrations

1. Glasgow's PRINCIPLES OF RADIO ENGINEERING
2. Terman's MEASUREMENTS IN RADIO ENGINEERING
3. Chaffee's THEORY OF THERMIONIC VACUUM TUBES
4. Hund's PHENOMENA IN HIGH-FREQUENCY SYSTEMS
5. Henney's RADIO ENGINEERING HANDBOOK

Special Low Price and Easy Terms

Bought singly, the five volumes comprising this library would cost you \$25.00. Under this offer you save \$1.50 and, in addition, have the privilege of paying in easy installments beginning with \$2.50, 10 days after receipt of the books, and \$3.00 monthly thereafter. Take advantage of these convenient terms to add them to your library now.

SEND THIS ON-APPROVAL COUPON

McGraw-Hill Book Co., Inc.
330 W. 42nd St., New York, N. Y.

Send me Radio Engineering library, 5 vols., for 10 days' examination on approval. In 10 days I will send \$2.50, plus few cents postage, and \$3.00 monthly till \$23.50 is paid, or return books postpaid. (We pay postage on orders accompanied by remittance of first installment.)

Name

Address

City and State

Position

Company QST 10-38
 (Books sent on approval in U. S. and Canada only)

Characteristics of Sky Wave

(Continued from page 85)

deal of the time. It also means that there will be more DX on 14 and 7 Mc. on account of the longer skip on these frequencies.⁵ In the summer the shortest skip-distance of the day will most likely be in the late afternoon or early evening, instead of at noon as in the winter months. However, there is one thing which sometimes compensates for the lack of F_2 reflections, and that is that during the spring and summer months there is much more chance of abnormal E -layer reflections than at any other time of the year. This may give good DX conditions, for a few hours at a time, on 30 and 60 Mc. when otherwise there would be none. It should also be mentioned that the change from winter to summer conditions is not a smooth one, and the spring and fall months are accompanied by a rather erratic behavior of the ionosphere. This has been noticed particularly by amateurs working regularly on the 30-Mc. band, where they find that unreliable transmission conditions precede and follow the rather poor, but relatively steady, conditions of the summer months.

CRITICAL FREQUENCIES

In most articles on radio transmission reference is made to "critical frequencies." A detailed knowledge of how these are determined is not of much interest to the average amateur, but since the term is so widely used he should at least know what it means. A critical frequency is the highest frequency which will be reflected from a given layer when the signal strikes it at right angles. If a signal will be reflected at right angles it will also be reflected from all other angles, and we see that the critical frequency of the F_2 layer, for example, is the highest frequency at which we will find zero skip-distance. It is a direct measure of the amount of ionization in a layer, and can be used to compute skip-distances for any frequency.⁶ The noon critical frequencies for Washington, D. C., in the past week are broadcast by WWV every Wednesday, but unless they are copied and recorded regularly to show the general trend of conditions, they will be of little use to the average amateur. His best bet is to listen intelligently on his receiver, and thus determine what conditions are at the actual time he wants to transmit.

Nearly every amateur who has been in the game three years or more has noticed how there was much more DX on 30 and 60 Mc. the past year than in previous years.⁷ This is the effect of

⁵ For work over several thousand miles these general rules are complicated by the daylight-darkness ratio and, in transmission over the Equator, the fact that summer conditions may prevail at one end of the circuit and winter conditions at the other. Generally speaking, DX conditions are most favorable in late winter or early fall, when the best balance between the various factors seems to obtain.—**EDITOR.**

⁶ Newburn Smith, "Skip Distance Calculation," *QST*, May, 1937.

⁷ Unfortunately (in the sense of obscuring to some extent the possibility of exact observation) also a period of increasing amateur activity. Nevertheless, most observers who have been active on those bands continuously will agree that DX conditions showed evident improvement during the period, perhaps more noticeably so on 60 Mc. than on 30 Mc.—**EDITOR.**

NEW JOHNSON "HI-Q" INDUCTORS

with ROTATING COUPLING COILS

**WORKS DIRECTLY
INTO LINE
WITHOUT TUNING
NETWORKS
OF ANY KIND**

- ★ For the first time a series of inductors with coupling coils capable of working directly into a 600 Ohm Line or less without tuning networks of any kind (10 and 20 meter units — all others will work into 75 Ohm impedances or higher).
- ★ Coupling coil can also be used with tuned feeders or Marconi Antenna.
- ★ Variation of coupling as desired.
- ★ Available without coupling coil for capacity coupled stages, etc.
- ★ Ribbed porcelain forms with extremely low dielectric loss.
- ★ Unaffected by ordinary heat and moisture.
- ★ For all bands 10 to 160 meters.
- ★ Two sizes, 250 and 750 watt rating.
- ★ Compact in size.
- ★ Steatite Mounting Base.
- ★ LOWER IN COST.

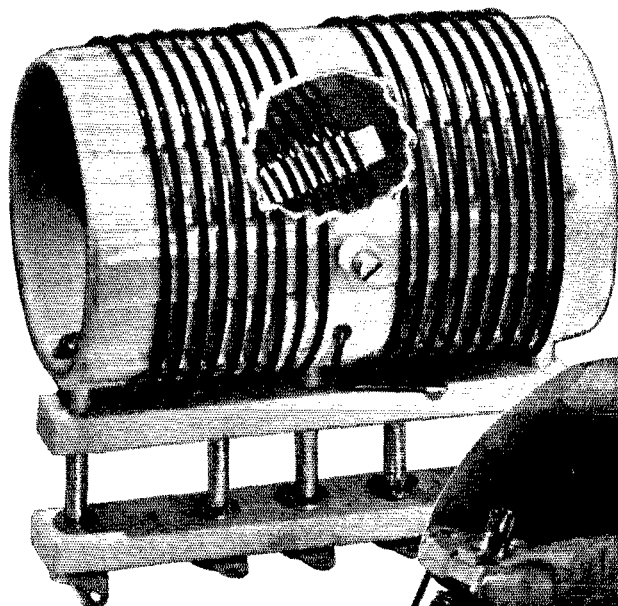

↑ Cut-out view of new Johnson "HI-Q" Inductors showing location of rotating coupling coil and Steatite mounting base. These efficient low-loss coils are also available without coupling coils for capacity coupled circuits.

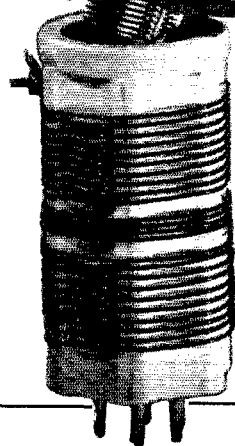

Here is a new series of Johnson "HI-Q" Inductors with rotating coupling coils that eliminate the need for antenna tuning networks of any kind. The rotating coils are located at the electrical center of the inductor permitting exact adjustment of coupling in interstage or output circuit. All sizes will couple into transmission lines of 75 ohms impedance, and this value increases with the high frequency inductors so that the 10 and 20 meter types will couple into any impedance up to 600 ohms. After adjusting, the coupling coils need never be disturbed, even when changing bands.

Included in the new Johnson "HI-Q" Inductor line is a series of small Fixed Coupling "Tube Socket" Inductors, wound on ribbed, low loss, low absorption porcelain of highest grade, equipped with 5 prong base to fit a standard tube socket. These new inductors are available for all bands from 10 to 160 meters and are designed so that a Johnson "Type J" Condenser may be fitted into one end to make a complete, compact LC unit. Rated at 75 watts, these inductors are available with coupling coils at the center or bottom of winding. See these new, more economical and more efficient "HI-Q" Inductors at your Johnson dealers or write today for catalog 965-J.

"TUBE-SOCKET" "HI-Q" INDUCTORS
Johnson "Tube Socket" "HI-Q" Inductor with fixed center coupling coils with Johnson Type "J" condenser inserted into the end of the inductor to make a complete LC unit.



E. F. JOHNSON CO.

WASECA, MINNESOTA

MANUFACTURERS OF RADIO TRANSMITTING EQUIPMENT

Here at last! TELEVISION

W2JKY calling!



"The TSS video chassis has everything the 'ham' wants. I've experimented with television for some time, but there's nothing

like the real thing — complete, practical and up-to-the-minute. I'm having fun galore, thanks to TSS television."
— DAVID BECK, 35 East 38th Street, New York City.

326 PARTS COMPLETELY ASSEMBLED
for the AMATEUR RADIO-VIDEO OPERATOR

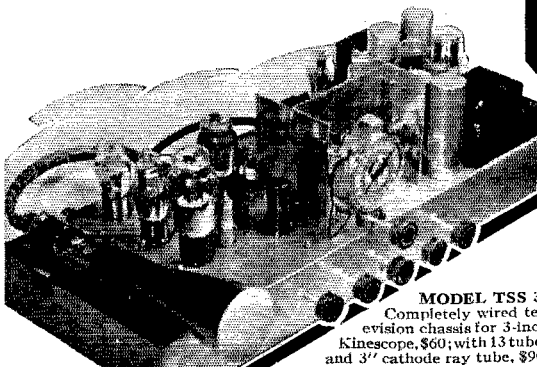

MODEL TSS 3: Completely wired television chassis for 3-inch Kinescope, \$60; with 13 tubes and 3" cathode ray tube, \$90.

MODEL TSS 5: Completely equipped for 5-inch Kinescope, \$90; with 15 tubes and 5" cathode ray tube, \$135.00.

Features of TSS Chassis:

- Modern All-Electronic
- Tunes throughout Tele Band
- Lowest Cost
- Compact Kit
- Triple tested

Useful for picture reception within range of existing experimental 441-line telecasting stations.

Television Sales and Service Corp.
1650 Broadway, New York, N. Y.

Please ship TSS Video equipment as ordered herein to address below:

Enclosed find M.O. Ck for \$——.
Deliver TSS 3: Chassis only With tube kit complete TSS 5: Chassis only With tube kit complete .

Name.....Call.....
Address.....
City.....State.....

TELEVISION

Sales and Service Corporation

1650 BROADWAY NEW YORK, N. Y.

the 11-year cycle of sunspot activity. The appearance of spots on the sun is an index of the activity of that body, and when we find lots of sunspots we also find periods of high ionization in our upper atmosphere. These sunspots have been objects of interest to astronomers for a great many years, and records of the number of spots are available as far back as 1750. These show that the number of spots usually reaches a maximum about every 11 years. The last maximum was during 1927 and 1928, so at the present time we are at, or very near, another maximum. It will probably occur sometime in 1938 or 1939, but the peak is rather broad and difficult to determine exactly. This then is the explanation of all our phenomenal high- and ultra-high-frequency transmission of the past few years. The average level of ionization has been increasing for the past five years, and as a result, higher frequencies have been returned to earth by the reflecting layers. It is probable that conditions in the winter of 1938-1939 will be as good as those of 1937-1938, or perhaps slightly better. So if we have increased occupation of the 30- and 60-Mc. bands we may see new DX records made in the year to come. After that, the DX hounds on 30 and 60 Mc. will gradually fall on evil times, and by 1944 and 1945 DX activity on these bands will have reached a new low, and we shall find 14 Mc. behaving like 30 Mc. to-day, and 7 Mc. will be a real DX band again. After 1945—but what's the use?

Before going to the ultra-high frequencies, a few points might be mentioned in connection with DX transmission at ordinary high frequencies. If you are working a station 1000 or so miles away, you are probably more interested in the status of the reflecting layers half way between you than in those over your head. For example, 14-Mc. stations on the East coast find that European signals begin to be heard in large numbers about sunset, Eastern Time, which means that the sun is no longer shining on the layers over the Atlantic, and they have had time to thin out a bit and stop absorbing so much energy from European signals. At the same time, stations on the West coast, about the same distance away, will not be heard so well because of the high absorption in the layers still in the sunshine over the middle of the United States. For very long distance transmission, such as to Australia for example, the signals will take several hops. That is, they will be reflected off the layer, bounce down and be reflected off the earth back up to the layer, where the process will be repeated. In such a case, during winter in the northern hemisphere the first reflection may be off the F_2 layer, while the second may be off a cloud of abnormal E layer in the southern hemisphere, where summer conditions hold.

U.H.F. TRANSMISSION—IONOSPHERE AND ATMOSPHERIC BENDING

In the ultra-high-frequency region we find that the frequency is usually too high to be reflected by the F_2 layer. If there are any such reflections, they will usually occur during periods of very high ionization, such as during a maximum in the

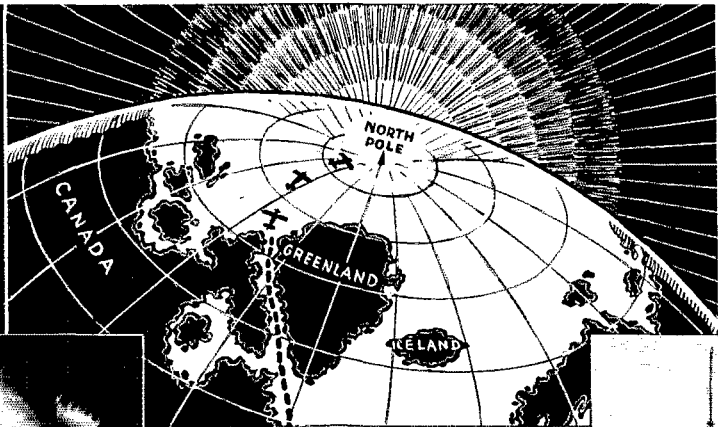

Capt. C. J. MacGregor
commander of the expedition

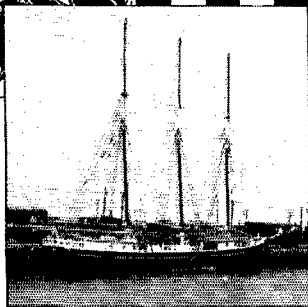

Schooner Gen. E. W. Greeley
carries the expedition

-and they're
THERE
with MacGregor

"ARE USING BURGESS BATTERIES EXCLUSIVELY FOR RADIO AND FLASHLIGHT SERVICE UNDER VERY SEVERE CONDITIONS AND GETTING EXCELLENT RESULTS.

**SINCERELY,
CAPT. C. J. MACGREGOR"**

This message was flashed from Reindeer Point, Greenland. Here the great MacGregor expedition was making final preparation before moving north to the vicinity of the Pole. It is an expedition that

will mean much to science because all types of weather phenomena will be studied.

Thus again, the problem of getting dependable portable power hundreds of miles from civilization is solved by Burgess. Here where battery failure might mean disaster, Burgess batteries are proving their superb workmanship.

The same quality, the same dependability, the same value are available to you for your radio and experimental work. Ask for Burgess batteries and be sure of long, economical, accurate service.

**BURGESS BATTERY COMPANY
FREEPORT, ILLINOIS**

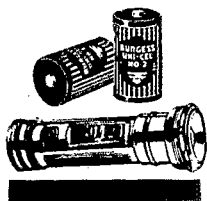

BURGESS



Say You Saw It in *QST* — It Identifies You and Helps *QST*

MEMBERSHIP SUPPLIES

Available only to A.R.R.L. Members

INSIGNIA OF THE RADIO AMATEUR

In the January, 1920 issue of *QST* there appeared an editorial requesting suggestions for the design of an A.R.R.L. emblem — a device whereby every amateur could know his brother amateur when they met, an insignia he could wear proudly wherever he went. There was need for such a device. The post-war boom of amateur radio brought thousands of new amateurs on the air, many of whom were neighbors but did not know each other. In the July, 1920 issue the design was announced — the familiar diamond that greets you everywhere in Ham Radio — adopted by the Board of Directors at its annual meeting. It met with universal acceptance and use. For years it has been the unchallenged emblem of amateur radio, found wherever amateurs gathered, a symbol of the traditional greatness of that which we call Amateur Spirit — treasured, revered, idealized.

Do You
Wear the
A.R.R.L.
Pin?

THE LEAGUE EMBLEM, with both gold border and lettering, and with black enamel background, is available in either pin (with safety clasp) or screw-back button type.

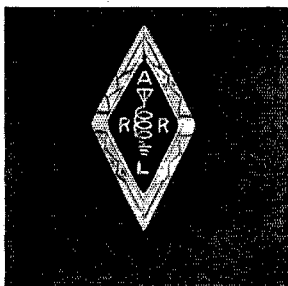

In addition, there are special colors for Communications Department appointees.

- Red enameled background for the SCM.
 - Blue enameled background for the ORS or OPS.
- (Red available in pin type only. Blue may be had in either pin or button style.)

THE EMBLEM CUT: A mounted printing electrotype, $\frac{3}{8}$ " high, for use by members on amateur printed matter, letterheads, cards, etc.

ALL EMBLEMS PRICED THE SAME

50c postpaid

STATIONERY



Members' stationery is standard $8\frac{1}{2}$ x 11 bond paper which every member should be proud to use for his radio correspondence. Lithographed on $8\frac{1}{2}$ x 11 heavy bond paper.

100 Sheets, 50c
250 Sheets, \$1.00
500 Sheets, \$1.75
Postpaid

THE AMERICAN RADIO RELAY LEAGUE
WEST HARTFORD, CONNECTICUT

sunspot cycle, and will take place only over very great distances where the signals strike the layer at nearly grazing incidence and are more easily reflected. This is the probable method of transmission of the European television signals, on approximately 41 megacycles, heard in this country and South Africa occasionally last winter. The medium long distance transmission of 60-Mc. signals which has taken place the past two or three years in April, May and June has mostly resulted from reflections from abnormal *E* layers.⁸ The area of one of these clouds of abnormal *E* layer ionization may be only a few square miles, and as a result it may furnish good transmission conditions only between relatively small areas. Of course several such clouds may exist at the same time in different parts of the country, and then we have a great number of transmission possibilities. In looking over the reports on 60-Mc. DX it seems that most of it took place in the late afternoons and evenings in the spring months. Ionosphere measurements have shown that abnormal *E* layer is also very likely to occur in the morning after sunrise, as well as in the evening, at that time of year. Perhaps if some of the fellows would get on the air before they went to work some spring mornings, we would have a lot more DX on 60 Mc. This applies to abnormal *E* layer transmission on 30 Mc. as well. In this connection it might be well to remark that real DX hunters won't let the fact that the band seems dead deter them from calling a CQ at any time, day or night, because they might catch a nice fat abnormal *E* layer ready to help them put a fine signal down in someone's back yard. Unfortunately there is no way of telling by making skip-distance observations when one of these abnormal layers is going to pop up.

Most persons who have driven a car in the summer time have, at one time or another, noticed what appeared to be water on the road ahead of them, only to find that when they reached the spot the water had disappeared. What they actually saw was light from the sky, and this mirage is caused by light rays from the sky striking heat waves rising from the paved road and being bent so as to strike the eyes of persons in the car. Ultra-high frequencies are considerably like visible light rays in their actions, and as a result we find we have a similar effect taking place in 60- and 120-Mc. transmissions. Normally as we go up in the air away from the surface of the earth the temperature of the air decreases, until it gets quite cold. Sometimes, however, we have a mass of warm air riding in over a mass of colder air on the surface of the earth, and then we find that as we go up from the surface it gets colder for a while and then we suddenly strike a warm layer. Here we have our highway mirage effect upside down. When the ascending ultra-high-frequency signals strike the rather sharply defined layer of warm air they are bent down toward the earth, and we find we have sky-wave transmission by bending in very low layers, from 1000 to 10,000 feet up. This important phenomenon was discovered by

⁸ J. A. Pierce, "Interpreting 1938's 56-Mc. DX", *QST*, Sept., 1938.

NEWARK OFFERS NATIONAL RECEIVERS ON EASY TERMS

**NUFF
★ ★
SED!**

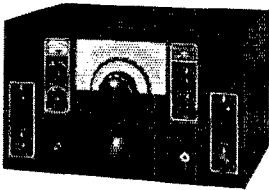

NC 100XA
New Low Price:
\$142.50 Cash

Complete with Tubes, Crystal and Speaker in cabinet to match. **PAY ONLY \$22.50 DOWN** and \$21.10 monthly for 6 months. Or \$14.21 for 9 months or \$19.80 for 12 months.

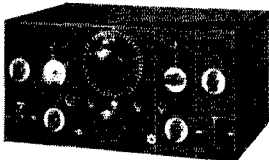

★
NC 101X
\$129 Cash Price

Complete with Tubes, Crystal and Speaker. **PAY ONLY \$24.00 DOWN** and \$18.58 monthly for 6 months. Or \$12.50 for 9 months or \$9.47 for 12 months.

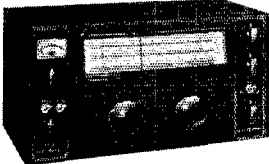

★
NEW NC44
\$49.50 Cash

Complete with Tubes and Speaker. Not sold on Easy Terms unless included with an order of \$60 or more. Order today direct from this Ad.

HRO
\$179.70 Cash

Complete with Tubes and Coils. **PAY ONLY \$29.70 DOWN** and \$26.14 monthly for 6 months. Or \$17.67 for 9 months, or \$13.45 for 12 months.

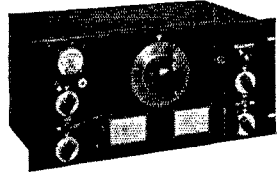

★
NC 80-81X
\$99 Cash Price

Complete with Tubes, Crystal and Speaker in Cabinet to match. **PAY ONLY \$19.00 DOWN** and \$14.36 monthly for 6 months. Or \$9.66 for 9 months or \$7.30 for 12 months.

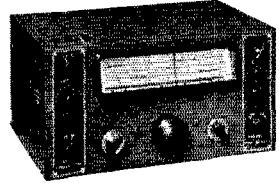

★
NEW NC 510
\$150 Cash Price

PAY ONLY \$25 DOWN and \$21.94 monthly for 6 months. Or \$14.77 for 9 months, or \$11.25 for 12 months. Order today direct from this Ad!

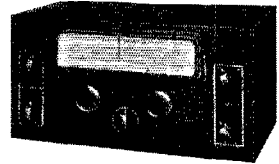

Oil Filled, Oil Impregnated FILTER CONDENSERS

Only **\$1⁰⁰**

1500 V. DC. 1 1/4 mfd.

2" Diameter Round Can. 2 3/4" high. Weight 1/2 lb. Well Known Makes. Bought at a lucky price! Quantities limited. First come, first served. Guaranteed at rated voltages.

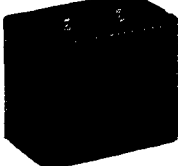

- 2 mfd., 2000 V. DC 4 3/4 x 3 3/4 x 1 3/4, 1 1/4 lbs. \$1.50
- 3 mfd., 1000 V. DC 5 x 3 3/4 x 1 3/4, 1 1/4 lbs. 1.10
- 3 mfd., 1250 V. DC 3 3/4 x 3 3/4 x 1 3/4, 1 1/4 lbs. 1.25
- 3 mfd., 1500 V. DC 5 x 3 3/4 x 1 3/4, 1 1/4 lbs. 1.50
- 4.4 mfd., 1500 V. DC 5 x 3 3/4 x 1 3/4, 1 1/4 lbs. 1.75
- 8 mfd., 2000 V. DC 5 x 3 3/4 x 3 3/4, 2 3/4 lbs. 2.75
- 10 mfd., 750 V. DC 4 3/4 x 4 3/4 x 1 3/4, 2 lbs. 1.75
- 14 mfd., 750 V. DC 4 3/4 x 4 3/4 x 1 3/4, 2 lbs. 2.00

NEW "FOREIGN ORDER" DEPARTMENT

Special Attention given to FOREIGN ORDERS in this new Export Department. Hams outside the U. S. be sure to WRITE TODAY for Big New Catalog and full details of Newark's New Foreign Order Dept.

Plate and Filament Transformers

600 VOLTS—200 MILS

Another Scoop by Newark. Famous plate and filament transformer made for us only. Thousands used in Ham rigs. 600—0—600 at 200 M.A.; 2.5 v. at 10 amps; 5 v. at 3 amps; 7.5 v. at 3 amps. Weight 10 lbs. Use this transformer for your buffer and final amp. stages. Just the thing for 46's, T-20's, 807's, etc. N. 1000. **\$2.95**

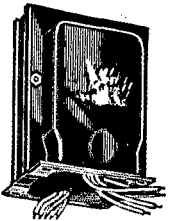

YOUR CALL LETTERS IN GOLD

Hams look at this! Your Call letters in impressive three dimensional style. Big shadowed decalcomania letters nearly TWO INCHES high. Put them on your HAM SHACK door, auto window, etc. Send dime for yours today. Be sure to give your call letters.

FREE! Get This Big New 1939 Ham Bargain Catalog

Illustrations, prices and full details on thousands of separate items, sets, tubes, parts and supplies! MAKE UP A \$60 ORDER and Buy All the supplies you need at present low prices. AND PAY ON EASY TERMS. Write for this Big 76-page Catalog Today.

NEWARK

Electric Company

323 W. MADISON ST.
Dept. Q CHICAGO, ILL.

ASTATIC MODEL D-104

*Still a Favorite
With the Hams*

Famous for low price, rugged construction and quality performance in the "speech range." A favorite with veteran amateurs the world over.

Model D-104 does not overload or "gum up" when used for close talking applications. Performance not affected by handling. No background noise. Annular ring diaphragm for maximum efficiency. High capacity parallel graphoil bimorph crystal element. Polished chrome finish. Fitted with interchangeable socket connector and 8-ft. single wire shielded cable. Full year guarantee.



ASTATIC

Astatic Microphone
Laboratory, Inc.
830 Market St.
YOUNGSTOWN, OHIO

Licensed Under Brush
Development Co. Patents

LIST PRICE

\$22.50

See Your Astatic
Jobber or Write
for Literature

*KING
OF Swing!*

Step into your jobber's and meet the "King of Swing!" Three of them, in fact! . . . **B & W SWINGING LINK ASSEMBLIES** in three sizes — for high, medium and low power.

They're **EFFICIENT!** . . . **ECONOMICAL!** . . . **POSITIVE!** . . . **ACCURATE!** . . . all these features combined in one inductance unit to give you the "last word" in efficient control

B & W SWINGING LINK units provide dependable, accurate control of loading and excitation in the final stages of your transmitter. Their exclusive **B & W** design allows convenient front-of-panel coupling control. Unexcelled to maintain positive balance by individually metering tube grids and plates in push-pull circuits.

For truly dependable, efficient performance — use **B & W SWINGING LINK ASSEMBLIES** in your new rig, or when you re-build.

See them at your jobber's — or write for complete information — today!

BARKER & WILLIAMSON

Radio Manufacturing Engineers • ARDMORE, PENNSYLVANIA

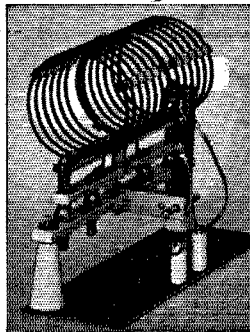

Ross A. Hull, and has been described in detail by him in *QST*.⁹ This is the sort of transmission that takes place over distances of from about 50 to 300 miles. On account of the turbulence in the air masses it is usually accompanied by fading, just as turbulence in the ionosphere causes fading on lower frequencies. Since the air mass conditions favorable to this kind of transmission generally

⁹ R. A. Hull, "Air-Wave Bending of U.H.F. Waves," *QST*, May, 1937.

TABULATION OF SKY WAVE TRANSMISSION CHARACTERISTICS

Condition of Ionosphere	Cause	Usual Time of Occurrence	Effect on Transmission
Weak ionization	Lack of energy from the sun.	Every night.	Long skip-distance, usually resulting in loss of all 30-Mc. and most 14-Mc. signals, with DX conditions on 7 Mc.
		Summer day (F_2 region).	Night conditions as above being found during the day.
	Minimum in the sun-spot cycle (every 11 years) (nearest one 1944-1945).	Long skip distance on all high frequency bands resulting in the loss of 30 Mc. most of the time with DX on 14 and 7 Mc. during the day.	
	Magnetic storm.	Irregular intervals.	Night conditions at all times on all bands during the duration of the storm, with severe fading often accompanied by distortion.
Strong ionization	Considerable energy from the sun.	Winter day.	Short or zero skip distance on 14 Mc. Zero skip on all lower frequency bands. Good 30-Mc. transmission conditions.
		Maximum in the sun-spot cycle (every 11 years) (nearest one 1938-1939).	Best conditions of transmission for the highest frequency bands, with shortest skip-distances on all bands.
Daily peak in ionization	Rotation of earth.	Winter at noon, summer at about local sunset (F_2 layer).	These are the times of the day for shortest skip-distance on all frequencies, and the time of day when the highest frequency can be used.
Abnormal E layer (very strong ionization)	Not definitely known.	May occur any time but most often in spring and summer after sunrise and sunset.	Medium long-distance transmission on high- and ultra-high frequencies including 60 Mc.
Dellinger fade-out (very strong ionization)	Not definitely known.	Most often at 55-day intervals.	Fade-out of all high frequencies caused by high absorption in low layers.
Temperature gradients in atmosphere (below ionosphere)	Air mass movements.	Precedes periods of unsettled weather.	50 to 300 mile transmission of ultra high frequency signals usually accompanied by fading.

AMATEURS-

A Speech Amplifier Designed For YOU



"BUILD IT YOURSELF"

by
THORDARSON

OVER-MODULATION CONTROL—Optional

Most versatile speech amplifier ever offered amateurs. Adaptable to any transmitter. Automatically prevents over-modulation through 6L7 tube in high gain stage. Complete diagrams and directions for constructing with or without over-modulation control feature. Available with 500-ohm output or driver ratios. Table or rack mounting (see illustrations below). Build with C.H.T. Multi-Match or regular Thordarson transformers. Start with Foundation Unit or Complete Kit of Parts.

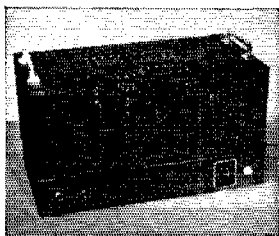
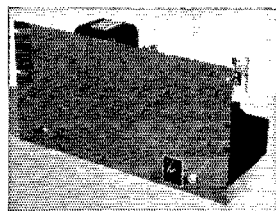

Table mounting with
metal screen cover.

COMPLETE INSTRUCTION BOOK

Full layout and constructional data for either over-modulation control or conventional circuit. Includes photos, diagrams, parts lists, performance data and operating procedure. SD-387. List price 15 cents.



Relay rack mounting
with panel.

SEE YOUR PARTS DISTRIBUTOR OR WRITE FACTORY
FOR FREE DESCRIPTIVE BULLETIN SD-389

THORDARSON ELECTRIC MFG. CO.

500 W. HURON ST., CHICAGO, ILL.

Demand "Power by Thordarson"

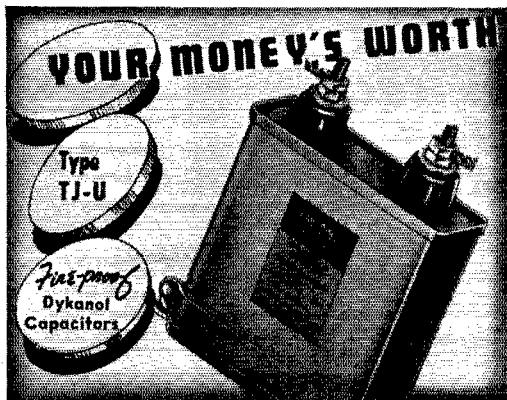

You get your money's worth, and more, with the Type TJU Universal Mounting Capacitors. These units are impregnated and filled with non-inflammable, non-explosive Dykanol, the high dielectric impregnating medium used in those big Navy jobs — permitting safe operation of capacitors at 10% above ratings.

Get the capacitors that are of proven quality. Remember C-D units have been imitated, copied — but never duplicated!

Described, listed and illustrated in the new 40 page Catalog No. 161 now off the press. Be sure to send for your copy today! Are you on our mailing list to receive "The C-D CAPACITOR" bi-monthly house organ? Absolutely free.

CORNELL-DUBILIER
ELECTRIC CORPORATION
1013 Hamilton Blvd., So. Plainfield, N. J.

E. H. RIETZKE, Pres. CREI

How Radiomen . . .
get more money
and better jobs with
CREI technical training at home

● Do you ever sit down and "look your job in the face"? Are you satisfied with your present position — or anxious to get ahead? Today, you can't afford to be satisfied — because rapid new developments mean that Radio wants only men who are **TECHNICALLY TRAINED**.

Better Men Get Better Jobs

Right now is the time to start training for more money and a better job. CREI offers you home-study training in **PRACTICAL RADIO ENGINEERING** to equip you with the ability to obtain and hold a better job.

TEAR OUT AND MAIL TODAY FOR FREE BOOK

FREE! New illustrated book, "A Tested Plan for a Future in Radio"

Name.....
Address.....
City.....



Capitol Radio Engineering Institute
Dept. Q10, 3924 16th St., N.W., Washington, D. C.

100

See You Saw It in QST — It Identifies You and Helps QST

precede periods of unsettled weather, it will be found most prevalent in the summer, and in sections of the country where thunderstorms and rainy weather are regularly experienced. It will usually occur less frequently in the winter, when meteorological conditions are more stable.

In this article no mention has been made of the characteristics of ground-wave transmission, a factor which is of considerable importance, particularly in ultra-high frequency propagation. Considerations of space have also made it necessary to omit many points that otherwise would have been included, no pretense being made that this article is a complete analysis of sky-wave transmission. Those who are further interested in the subject may find the following list of articles of interest. A good bibliography was given at the end of Dr. Kenrick's excellent article on the ionosphere in *QST* for September, 1936, and only articles appearing since then are listed below. Most of them contain considerable material that is neither mathematical nor difficult.

1. Gilliland, Kirby, Smith and Reymer, "Characteristics of the Ionosphere and Their Application to Radio Transmission," *Proc. I.R.E.*, Vol. 25, No. 7, July, 1937.
2. Judson, E. B., "Comparison of Data on Ionosphere, Sunspots and Terrestrial Magnetism," *Proc. I.R.E.*, Vol. 25, No. 1, January, 1937.
3. Mimmo, H. R., "The Physics of the Ionosphere," *Reviews of Modern Physics*, Vol. 9, January, 1937.
4. Conklin, E. H., "New Ionosphere Broadcasts," *Radio*, October, 1937.
5. Conklin, E. H., "Determination of Skip Distance," *Radio*, April, 1938.

Strays

During a recent 5-meter QSO between W8MVQ and W2DMM/8, the antenna at 8MVQ was blown down. W8MVQ immediately went out on the roof and held the antenna up with one hand while he held the microphone in the other. Not only did 2DMM/8 continue to receive him, but he gave him a report of signal increase of 2 "R's." Maybe this is the proper cure for 5-meter antennas that don't seem to "get out" as well as expected!

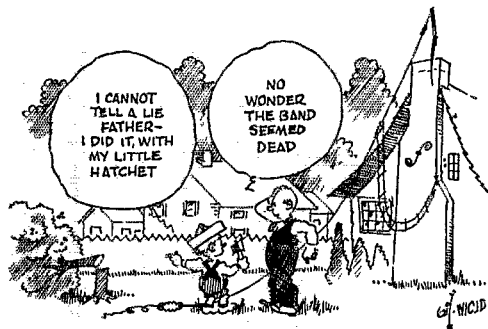

— IF IT HAD HAPPENED TODAY —

Station Operating Supplies

Designed by A.R.R.L. Communications Department

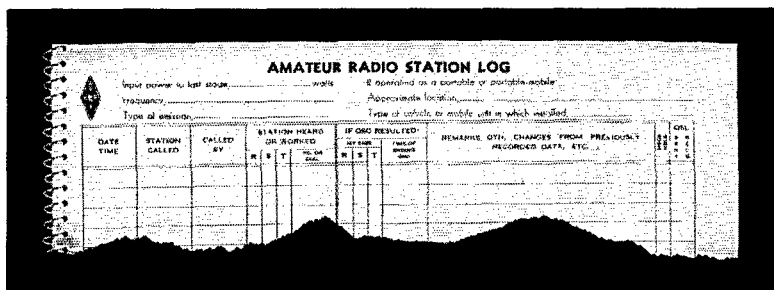

★
**THE
LOG
BOOK**
★

As can be seen in the illustration, the log page provides space for all facts pertaining to transmission and reception, and is equally as useful for portable or mobile operation as it is for fixed. The 38 log pages with an equal number of blank pages for notes, six pages of general log information (prefixes, etc.) and a sheet of graph paper are spiral bound, permitting the book to be folded back flat at any page, requiring only the page size of $8\frac{1}{2} \times 11$ on the operating table. In addition, a number sheet for traffic handlers is included with each book. The LOG BOOK sells for 35c per book or 3 books for \$1.

OFFICIAL RADIOGRAM PADS

The radiogram blank is now an entirely new form, designed by the Communications Department to comply with the new order of transmission. All blocks for fill-in are properly spaced for use in typewriter. It has a strikingly new heading that you will like. Radiogram blanks, $8\frac{1}{2} \times 7\frac{1}{4}$, lithographed in green ink, and padded 100 blanks to the pad, are now priced at 25c per pad, postpaid.

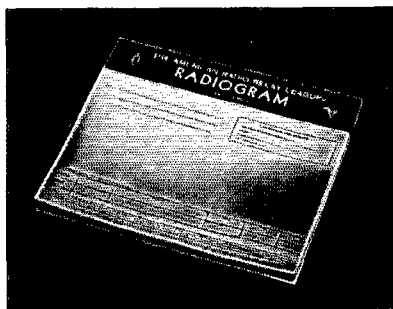

and MESSAGE DELIVERY CARDS

Radiogram delivery cards embody the same design as the radiogram blank and are

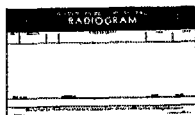

available in two forms — on stamped government postcard, 2c each; unstamped, 1c each.

AMERICAN RADIO RELAY LEAGUE, Inc.
West Hartford, Connecticut

Your Inquiries Invited . . .

When you need amateur equipment it is to your advantage to write to Bob Henry, W9ARA. You get personal attention; terms financed by myself so you buy with less cost and more convenience; fair trade-in value for your equipment; ten day trial of all receivers; and my cooperation in every way to see that you are 100% satisfied. No wonder Bob Henry's customers are boosters. You will be too. For the newest equipment, the latest information and technical help:

WRITE TO: BOB HENRY, BUTLER, MISSOURI

Compare Bob Henry's Terms With Others

Model and Receiver	Cash Price	Down Payment	12 Monthly Payments
The NEW RME-70	\$138.60	\$27.72	\$9.79
The NEW NC-44	49.50	9.95	3.52
NC80X and NC81X	99.00	19.80	6.99
Improved NC101X	129.00	25.80	9.11
The NEW NC100A	120.00	24.00	8.48
Latest RME-69	152.88	30.57	10.80
Sky Champion	49.50	9.90	3.49
Sky Challenger II	77.00	15.40	5.44
Super Sky rider	99.00	19.80	6.99

Also Super Pro, HRO, PR15, Breting 9, Sargents, others.

Similar terms on Harvey, RCA, RME, Temco transmitters and National, Thordarson, Progressive, Utah, kits.

Export orders solicited too

HENRY RADIO SHOP

211 North Main Street Butler, Missouri

FOR BED ROCK STABILITY— ON ALL BANDS

THE BL EXCITER TWINS

BL-5G and BL-5P

Build Your Own Band Switching Exciter!

- ★ 10 to 160 meters at the throw of the switch.
- ★ Double to 5.
- ★ High-C grid circuit — High-L plate circuit.
- ★ Change from EC to crystal at will.
- ★ EC note cannot be distinguished from crystal.
- ★ A transmitter in itself.
- ★ A driver for a 200 watt final.
- ★ Simple — Effective — Inexpensive.

A CLEAR CHANNEL AWAITS YOU with This Modern Amateur Equipment

KILL —

IMAGE INTERFERENCE on the HAM BANDS

The BL 5-H band switching tuner provides an effective and inexpensive means when utilized in a simple and efficient preselector. A universal tuner giving complete bandspread on the 10-20-40-80-160-meter bands, this versatile unit forms the basis of a receiver, a signal generator, a field strength meter and a host of other apparatus.

See Your Parts Distributor — Write for Details

BROWNING LABORATORIES INC.
WINCHESTER, MASS.

EXPORT DEPT., 461 4th AVENUE, NEW YORK

A.R.R.L. QSL Bureau

FOR the convenience of its members, the League maintains a QSL-card forwarding system which operates through volunteer "District QSL Managers" in each of the nine United States and five Canadian districts. In order to secure such foreign cards as may be received for you, send your district manager a standard No. 10 stamped envelope. If you have reason to expect a considerable number of cards, put on an extra stamp so that it has a total of six-cents postage. Your own name and address go in the customary place on the face, and your station call should be printed prominently in the upper left-hand corner.

- W1—J. T. Steiger, W1BGY, 35 Call Street, Willimansett, Mass.
- W2—H. W. Yahnel, W2SN, Lake Ave., Helmetta, N. J.
- W3—R. E. Macomber, W3CZE, 418 10th St., N. W., Washington, D. C.
- W4—G. W. Hoke, W4DYB, 328 Mell Ave., N. E., Atlanta, Ga.
- W5—E. H. Treadaway, W5DKR, 2749 Myrtle St., New Orleans, La.
- W6—Horace Greer, W6TI, 414 Fairmount Ave., Oakland, Calif.
- W7—Frank E. Pratt, W7DXZ, 5023 So. Ferry St., Tacoma, Wash.
- W8—F. W. Allen, W8GER, 324 Richmond Ave., Dayton, Ohio.
- W9—Roy W. McCarty, W9KA, 11 South Michigan Ave., Villa Park, Ill.
- VE1—J. E. Roue, VE1FB, 84 Spring Garden Rd., Halifax, N. S.
- VE2—C. W. Skarstedt, VE2DR, 236 Elm Ave., Westmount, P. Q.
- VE3—Bert Knowles, VE3QB, Lanark, Ont.
- VE4—George Behrends, VE4RO, 186 Oakdean Blvd., St. James, Winnipeg, Manitoba.
- VE5—H. R. Hough, VE5HR, 1785 First St., Victoria, B. C.
- K4—F. McCown, K4RJ, Family Court 7, San-turce, Puerto Rico.
- K5—Norman F. Miller, K5AF, 15th Air Base Squadron, Albrook Field, Canal Zone.
- K6—James F. Pa, K6LBH, 1416D Lunalilo St., Honolulu, T. H.
- K7—Dean Williams, K7ELM, Box 2373, Juneau, Alaska.
- KA—George L. Rickard, KA1GR, P. O. Box 849, Manila, P. I.

Strays

On July 29, 1938, W7FHX of Lakeview, Oregon, received from W7FQS of Spokane, Washington, a QSL card which was postmarked April, 1936. The card had covered the 600 miles in two years and three months. It had been addressed to Lakeview, Washington, through error.

Did someone say that messages via amateur radio were sometimes slow?

Now! A 5, 10, 20 METER KIT with a complete Band Switching System

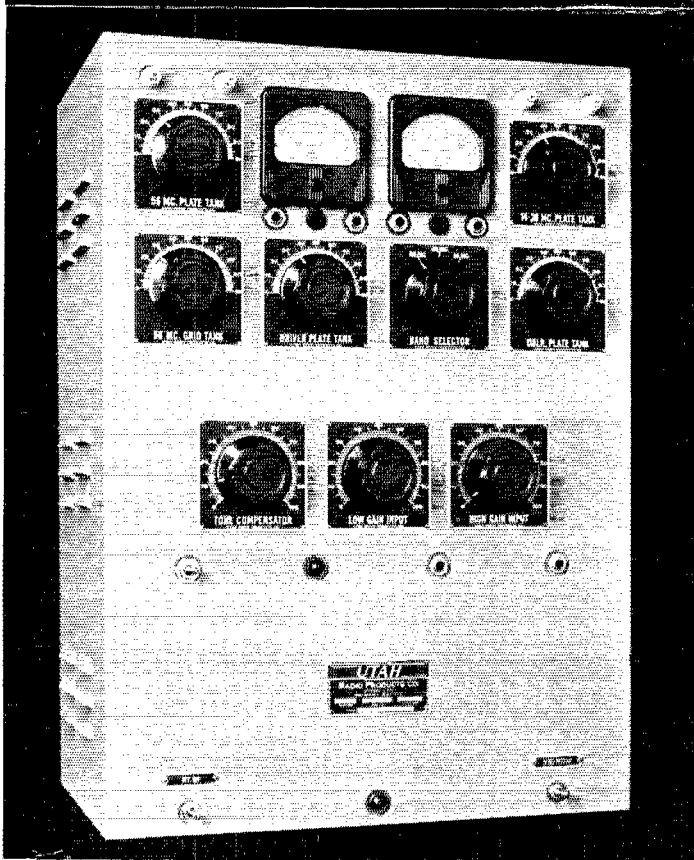

for only
\$69⁷⁵.
Less crystal, meters
and tubes!

Check These Features

1. Complete Band Switching of circuits — no "plug-in" coils
2. Independent Dual Amplifier Stages
3. Provision for Two Crystals
4. 45 Watts Input — CW or Phone
5. High Gain Speech Amplifier — Modulator
6. Two complete power supplies with 3 filters
7. Steatite insulation — "air wound coils"

Here's a highly efficient 5-10-20 meter transmitter kit with plenty of power and *instantaneous band switching* — no plug-in coils or pruning of condenser capacities to obtain proper L C ratios.

A special low resistance selector switch, used in conjunction with the two separate Class "C" Amplifier stages, automatically selects the proper tube sequence.

All parts are of Utah's high standard of quality, with Steatite insulated R F sockets, condensers, etc. — a professionally styled job throughout.

It's the unit for any amateur who wants to work the interesting 5 and 10 meter bands as well as 20 meters.

Write today for complete specifications and schematic wiring diagram.



UTAH RADIO PRODUCTS CO.
CABLE: UTARADIO, CHICAGO

"DEPENDABLE SINCE 1922"

Station Activities

DAKOTA DIVISION

NORTH DAKOTA—SCM, Ernest Bloch, W9RZA—WWL holds following appointments: O.P.S., O.B.S., Emergency Coördinator—also state representative in American Emergency Net, President of the Upper Missouri Radio Club and Vice-President of the Glacier Park Hamfest; he also is member of A.A.R.S. State 'Phone Net. CGM is rebuilding his r.f. into a 8L6X-T20-03A. OJS is new call in Williston. GMY is rebuilding to '47 crystal '10 final on 3.5 Mc. ZTL is looking for Ariz. and S. Car. QSO's to complete his W.A.S., also plans on giving 1.75-Mc. 'phone a try. JZZ wants to sell his rig, with two r.f. sections, for \$35. UGM is the proud owner of a Class A ticket and is rebuilding for 14- and 3.9-Mc. 'phone. Grand Forks hams organized a radio club with LPE, Pres., PHH, Vice-Pres., NAW, Secy.-Treas. and DIW, Activities Mgr. Interest in the club is very high and present membership is about 20.

Traffic: W9WWL 24.

SOUTH DAKOTA—SCM, Al Russell, W9VOD—AZR, R.M., E.C.; SEB, R.M.; OXC, O.O. SRX worked G6QS, presumably giving him the first G WAS. ZMW left for a radio job in the airport at Fargo, No. Dak. VQN entertained half a dozen ham tourists in August. SEB clicked with K6, G8, ZS5 and ES5. ZCC says increased power is worth the trouble it brings, hopes the fall season brings the Roundup gang together again. VOD will trade some swell European S.W.L. cards for a European QSO. YOB visited VQN, SEB, PLF, OXC and QVY on his vacation trip. QAK has a new Sky Champion. QVY is building new rig. AZR had to return the borrowed power transformer.

NORTHERN MINNESOTA—SCM, Edwin Wicklund, W9IGZ—PZU of Staples will start transmitting the Official A.R.R.L. Broadcasts the first Sunday in October; the time will be 7 P.M. C.S.T. on Sundays and Wednesdays on 3003 kc. Listen every week and tell others about these broadcasts. LSC has a lot of fun working DX on 14-Mc. 'phone. YKD is building new rig using 59, RK-49 and '10. KQA works lots of W6's on 14 Mc. OCN is new St. Paul ham on 7 Mc. YCR runs 180 watts to 809. NIM has an 809 in final. PZU is building new rig using 250T final. VVA has a T200 in final of new rig. DRK put up a rhombic antenna. AZE is building a rig for ORE with pair of 807's in final. ZOB, now located at Long Prairie, works 7 and 3.5 Mc. HEO, VVA and AZE are working on the new by-laws for the Min-Dak Radio Club. The Min-Dak Club had its August meeting at your S.C.M.'s place. 73.

SOUTHERN MINNESOTA—SCM, M. L. Bender, W9YNQ—DCM will probably handle the S.N.C.S. in the A.A.R.S. this season. VRY is building a new r.f. receiver. TPZ is stepping around with his new 14-Mc. rig. FNK intends to move to his new QTH near the Twin Cities. ZSX dropped in for a visit with YNQ. YNQ has his new rig going. The Rochester Radio Club has a swap night; it helps keep up interest in meetings. An attendance prize is given at each meeting. The City of Rochester has donated the use of a room in the municipal Electric Light plant for a clubroom. The A.A.R.S. gang is getting their rigs tuned up for the season's drills. The U. of Minn. Net starts as soon as school starts at the university; this net handles traffic for students attending the "U"; YC is the control station. LCT is new O.R.S.; he and ZLZ kept a 1.75-Mc. schedule all summer. SJK is looking for a 70-foot pole; has had the hole dug a year! BP is on the trail of some 50 poles. DCM is kept busy by the gang in Minneapolis getting the power company to put up their masts. LTC wants 3.5-Mc. schedules.

MIDWEST DIVISION

IOWA—SCM, C. C. Richelieu, W9ARE, W9ZQW, new O.R.S., is showing fine traffic totals. QVA is new O.R.S. KFP is new ham in Mason City. QED has new antenna mast. YKC worked a ZL on 7 Mc. GLR is working 'phone on all bands. CCY has new Hallierators 56- and 28-Mc. receiver. UQJ has new HRO. PDI moved to Lincoln. Neb. PDM is building bias packs. QAQ has new HK-254 P.P. final. QUF runs 75 watts into 809 final. GFQ has 1-kw. rig in operation. REV took first cruise with Naval Reserve. JRY is on 14-Mc. 'phone. BZY has new antenna. OC (the Old Crow) reports. YQY built new power supply with 866 Jr. and worked VK3 on 7 Mc. ZTV moved to Ames to attend engineering school. AF and YTT are active again. YRO has new 14-Mc. doublet using EO1 cable. OLI and OLK are new hams in Sioux City. UGT finds new iron-core IF's in

receiver FB. VRG is building 56-Mc. rig. TMY bought ARE's complete crystal cutting and grinding equipment and is now turning out extra FB "Hawkeye Jewels." QOQ is experimenting with 56 Mc. WNL wants schedules with checker players on any band. WMP is working DX on 7 Mc. GKN, new ham in Burlington, bought the UNL transmitter. WTD holds office of Pres. in the I-I Amateur Radio Club at Burlington. LAC worked a 28-Mc. 'phone in N. J. and hasn't come out of it as yet. QGU is assisting LAC with transmitter and antenna troubles. PJR has FB 56-Mc. crystal-controlled rig—used it in Burlington hidden transmitter hunt with excellent results. NIA entered Burlington hidden transmitter hunt. ARE had a visit from CIH and YF. UOP has splendid State Emergency Net working on 1907 kc. Our deepest sympathies to FSH in the passing of his mother. Due to the inactivity and failure to report to S.C.M. it has become necessary to cancel several appointments in this Section. We regret doing this, but feel that in so doing we may be able to impress upon all appointment holders that we want activity and interest in League work. Each club please nominate your Emergency Coördinator and advise S.C.M.

Traffic: W9ZQW 55 QVA 3.

KANSAS—SCM, Harry E. Legler, W9PB—Traffic took a new lease on life when NI at National Guard camp was opened up for the summer camps. FRC, CET, APF, KXB, VWU, RAT and WYL were some of those keeping folks at home in touch with the boys at camp. APF moved from Hutchinson to St. Marys. AJJ is getting cards for work done by someone using his call. QCA, formerly 5FLY, is now in our Section. ZAW stays on the air with his 10-watt emergency rig while the big rig is being overhauled. WIN was hurriedly called back from his eastern trip and missed visit to IAW. LVD (ex-9BSV-4KE) is back in the game after being out for 10 years. UEG reports that BUY and KUZ are new calls in Sterling. QLI reports HCG is moving and that QNB has new Jr. op. HCG has a son with operator ticket who helps at the home station and another son whose call is ZJE. NFG lets us know that VUV and UDB are getting in all the operating they can before going off to distant schools; WBC is at C.M.T.C.; GOW is new call at Fredonia; VAO is adding T55 to his final; BPL is suffering from beam antenna headache; UDG is recovered from car accident. NFG's description of new exciter sounds worth investigating. RAT says the Coffeyville Club is working up a hamfest which will feature portable stations and A.E.C. work. TKF and YLY are busy on 28 Mc. QNQ is vacationing in California and visiting the W6's. QQI is getting out on 7 Mc. YQD works consistently on 1.9-Mc. A.E.C. Net on Sunday mornings.

Traffic: W9NI 780 APF 388 FRC 210 CET 44 UEG 17 LVD 11 WIN 8 QLI 3 ZAW 2

MISSOURI—SCM Letha Allendorf, W9OUD—NIP is about to blossom forth with a new rig. QXO handled traffic for the N. G. when it was in Fort Sill, and has traffic schedules every morning on 3875 kc. OGW is a new ham in Kirksville. NNZ can still swing a bug with his old style. In Poplar Bluffs, FYF, OLC and SOC are new hams. ZAO is studying for his First Class Radio Telephone ticket. OMG worked ZB2H for a new country. ISB is trying 28 Mc. VID is rebuilding. HHT sold his rig to ZFD and quit ham radio. QHL has turned "Hill Billy" over KWOC, and AXL broadcasts over the same station. KEI and VMH are rebuilding. KEF finished his portable outfit—receiver and transmitter in cabinet 10 x 8 x 14 weighing 27 lbs., 10 watts on 3.9-Mc. 'phone. WVQ is new O.P.S. QCV has a new antenna. QCO has been rebuilding. QMD says the Springfield hams are forming a club. EYG is back on and rarin' to go. VZQ had 250 watts on 1.75 Mc. and says he worked all sections with 7 watts instead of all states as previously reported. DEN has an XYL up at his place now. SGP is working at KTJS in Jackson, Tenn. FQX is on 14 Mc. with new P.P. T-40 rig. BMA has been demonstrating a portable rig he has built for LLW, who is travelling with an orchestra. JWI burst forth again on 7 Mc. with 7 watts to a crystal oscillator. UYD worked PK6XX on 14 Mc. QJP has a little YL at his house now. TGN has been handling most of the traffic for the Seventh Corps Area A.A.R.S. this summer, and is commander of the U.S.N.R. unit in Joplin. KJM visited his folks in New York. SRH will be back from college for a few weeks. OSK spent a couple of days of hard labor on OUD's transmitter and the results are very satisfactory. OUD is seconding TGN on the WLM net and keeping a few schedules. The Missouri Traffic Net will start operating about the

middle of September, time and frequency tentatively fixed as 7.30 P. M. and 3775 kc. We invite your participation and cooperation. Those blank spaces on the bottom of reports cards are for news. Try 'em sometime. 73.

Traffic: W9TGN 502 OUD 180 QXO 59 GBJ 6 UYD 5 EYM 2 QMD 1 VMH 2.

NEBRASKA—SCM, S. C. Wallace, W9FAM—ZFC reports the "Z" Net is working very FB west. FAM gets on Sunday mornings for rag chews. FFF has new rig with 211. EHW is operating in emergency nets on 1.75-Mc. 'phone, and experimenting some with 7- and 14-Mc. c.w. DI has been acting as control station on 'phone for the 3rd District Emergency Net in Nebraska. UHT is putting up new Zepp. YDZ reports N. E. Nebr. Radio Club held meeting at Norfolk at home of QJJ. 6PAF visited Norfolk and Wayne gang. MPY and MJL joined N. E. Nebr. Radio Club. QFT and DLX applied for membership. DHO worked G and got an S.W.L. card from Africa. Rep. Carl Steffan gave a talk before N. E. Nebr. Radio Club. YDZ worked So. Car. and needs only Miss. for W.A.S. ZAR stopped in to say hello to FAM; he was hitch-hiking to Colo. FAM, NFL, EKQ and AXN got together on 7 Mc. and did a little planning for trunk line "L" for the coming Season.

Traffic: W9ZFC 88 DI 20 EHW 15 FFF 14 ZFC 1.

CENTRAL DIVISION

ILLINOIS—SCM, Leslie M. Dickson, W9RMN—FFQ is using crystal control on 56 Mc. KOK is a new ham in Rockford. A new club formed in E. St. Louis—the Cahokia Radio Club. IMB, new O.R.S. in Chicago, is studying for commercial ticket. PLL reports from Maryland. DBO is working DX. RZU is working for Northwest Airlines in Minneapolis. YFV, the second op at RZU, was severely burned when he got across the antenna on the 28-Mc. rig. PRS has a new 500-watt rig. VS, the Corps Area Cryptographer, has moved to Chicago. ZEW's "Z" net on 7 Mc. is going strong. BPU says his new 137-ft. Zepp is FB for DX; he and UAT worked AC4YR for YR's first DX contacts. MIN has a signal shifter and a 100TH final. Congratulations to ULJ, recently married. When you read this, the state net on 3765 kc. will again be operating. The extreme southern part of the state is not very well represented at present. Any interested party from that section please get in touch with RMN, or any net member.

Traffic: W9HPG 91 DDO 75 VS 39 MRQ-EBX-ZEW 20 PRS 11 KMN 10 QH 6 BRY 5 NFL-BE 3 TUV-NHF-SKR-IMB-CEO 2 KJY (WLTK 25).

INDIANA—SCM, Noble Burkhardt, W9QG—ANH, NVP and OMR are new hams in Terre Haute. BWI has new call—KHCD. CB received commission as ensign in U.S.N.R. DET has been messing around on 56 Mc. FLV sold out to ZHL. HTX got on the air again so he could renew his license. KBL is new station in West Lafayette with 6L6. LYK met VE50M—ask him about it! NGS got hitched on June 30th—FB. OEM starts off with a '03A on 7 Mc. OVF worked China for DX this month. TE is rebuilding a little. WOD wants O.R.S. ZNC is back on the air begging for traffic. ZYC finds DX swell on 7 Mc. these mornings. A new radio club has been organized in Gary with DQK pres., OVF v.-pres., and MJH treas. TE, OVF, CLE, SPB and JYP went on U.S.N.R. cruises this summer. The Turkey Run picnic was a big success in spite of an all-day rain. HRW won the 56-Mc. transmitter hunt. Anyone wanting information on the A.A.R.S. please write the S.C.M.

Traffic: W9AXH 2 EGQ 7 OVF 36.

KENTUCKY—SCM, Darrell A. Downard, W9ARU—Everyone in this Section is rebuilding, and the minimum power seems to be 999 watts. Well, we'll take the fellow with a UV202 who is on consistently, rather than the kw. guy. ZJS is on 7 Mc. with a pair of T40's. VYY sends a long letter and tells of the activities of the fellows who don't report. BEW paid the S.C.M. a short visit. HNV and WUR are getting their sea legs à la Naval Reserve. NOX, LCM and JWE evidently like summer time operation. EDQ has a new rig and brags about its appearance. UKD, Owensboro Association of Radio Amateurs, should now be working in the KYN. With the number of operators they have, UKD shouldn't miss a schedule. FQQ couldn't get up an antenna where he lived—so he moved. A.R.T.S. resumes its meetings October 8th. ARU has been keeping nightly schedules with Gulf Coast stations in the L. & N.R.R. Net due to it being open season for Gulf storms.

MICHIGAN—SCM, Harold C. Bird, W8DPE—Eights: PGJ visited with folks at nearby lake, working portable

from there. R.M. NLD returned from cruise with BGX, LYZ and MCV on S.S. *Dubuque*. CMH reports big score in O.R.S. contest. NUV has been rebuilding since O.R.S. contest. RYP reports for first time. SS reports FB signal from PVK while at Grayling. PLC is busy with R.M. work and building up equipment. MGQ wants O.R.S. appointment. OCC is trying to master the art of bug sending. BRS reports visit from FWU. AIZ reports MAS and CXT on QMN. MBM averages one QSO a week on 3.5 Mc. HKT reports SIO new ham. DYH reports that ICM took the marriage vows on Aug. 27th. MV says new radio room is nearly complete. RJC drove 200 miles to help on air show. FB, Herb. FWU and GP report. PVK was located at National Guard encampment and operated by QGD and FTW. JUJ is going to handle things at Frankfort glider meet on his vacation. SCS enjoys working QMN. FX reports new poles on house and in back yard. CAT is going east on vacation. DPE is all set to handle Field Day reports. RMH has nice signal now and wants O.R.S. RVE is new reporter from Army flying field at Mount Clemens. PDJ built up rig for QMN. Nines: JYT has been handling traffic from National Park station at Isle Royal. Silent Key: James R. Weston, W8AIN, River Rouge, left us the first of August.

Traffic: W8AIZ 156 QGD 110 MQG 101 CMH 80 JUJ 74 PVK 58 RMH 37 DYH 35 SS 8 PLC 32 RJC 23 DPE 21 GP 20 RVE-MV 14 PYT-FX 10 OCC 8 NDL 5 JAH-HKT 2 W9CWR 2.

OHIO—SCM, E. H. Gibbs, W8AQ—BBH continues to lead in traffic by virtue of A.A.R.S. Net schedules. A couple of 3.9-Mc. 'phone stations, PUN and OZH, handled a nice volume of traffic with Scout Jamboree station at Marietta. HQZ turns in nice total on his first report. EEQ is in trans-con net on 7 Mc. REC made W.A.S. and has gone to 14 Mc. for W.A.C. PGI has been hunting DX on 14 Mc. and is close to W.A.S. and W.A.C. PSF has come back to life as fall approaches. LVH and LVU have been working on rigs for new season. RIX spent a month at C.M.T.C. camp. New e.c.o. at DWT. RPS has been on 3.5 Mc. while rebuilding 1.8-Mc. 'phone rig. SYG is new ham at East Liverpool with 6A8-HY25 rig. GVX built new band-switching transmitter. BAH went on U.S.N.R. cruise and reports Cleveland gang ready to handle National Air Races communications. PUN has installed break-in on the 'phone rig. OZH has new e.c.o. perking on 3.9 Mc. SEN is new-comer at Elyria on 3.5 Mc. KKH divides time between 3.5-Mc. c.w. and 'phone on several bands. JFC has new signal shifter and was first W8 'phone contact for PK6XX on 14 Mc. PNJ has new T40. Piqua gang staged FB hamfest, August 7th. AXQ has new stick 91 feet in the air and works 56 Mc. mostly. FHB had trouble with power supply and is now on reduced power. CDR has fine success with 14-Mc. rotary antenna. LWT returned from vacation in VE2 area. PZO is planning new rig for new location. PBX moved rig to new room he built in basement. OVL has been experimenting with rotary antennas. KNF blew modulation transformer, so is temporarily on c.w. IAL rebuilt with T55 final. Toledo gang had 56-Mc. Field Meet in July. RBK is on 3.5 and 7 Mc. with 6L6 final. AQ had fun with 10-watt portable rig in Maine and Mass. on vacation. HCS will hold post in Trunk Line "L" and National Trunk Net this season. NXN spent two weeks at Fort Knox. Two new hams in Lancaster: SGE and SGB. SGE built a monitor in a small land bucket; en route to OXF's shack he started to take a short cut through a cemetery; but the caretaker said, "Get out of here, there are no berries in here!" OXF has P.P. 100TH's in final with 750 watts on c.w., 450 on 'phone.

Traffic: W8HCS 120 PUN 110 HQZ 86 OZH 66 EEQ 7 REC 35 BBH 23 (WLHA 218) PGI 12 EQN 11 FNX 0 PSF 6 KKH 5 LVH-JFC 4 PNJ 3 RIX-AXQ 2 FHB-DWT-AQ-NXN 1.

WISCONSIN—SCM, Aldrich C. Kronos, W9UIT—NRX has new Junior op. SJF has been stalking DX on 14 Mc. all summer. IYL is building stabilized e.c.o. for all bands and playing around on 56 Mc. with a directive antenna. 1KJK is going back East after having fine time in W9 district. 9ONI has been on 1.75 Mc. most of the summer. By the time this appears in print the State Net will be in operation on 3775 kc. DXI expects to get on 14 and 3.9 Mc. soon. ZTO worked PK6XX for an even 50 countries on 'phone. QJB is ready to go on 28-Mc. 'phone. JHP corrects our report on the F.D. activities of the D.R.R.C.; the 'phone camp consisted of HHR, FGU, YYZ and RBI; in the c.w. camp were DIR, WDI, HFA and JHP. SZL re-

(Continued on page 108)

FOR 10 AND 20 METERS

Vertical Steel Radiators

- FULLY TELESCOPING AND ADJUSTABLE
- QUICK, EASY TO INSTALL
- NO LONG PIPES TO HANDLE
- SIMPLY ERECT 6-FOOT UNIT AND EXTEND TO HEIGHT DESIRED
- SPECIAL DESIGN 25,000 VOLT INSULATOR SIMILAR TO 800-FOOT TOWER TYPE

Made of steel tubing in carefully designed sizes to permit telescoping to 6-ft. unit yet extending to any height up to 34 ft. for 20-meters. Six sections with 3-point locking joints, all heavily copper plated for minimum R.F. resistance.

10-Meter Radiator is of three sections, employing the famous Corulite Elements—extending to 17 feet. Ask your jobber or write direct.

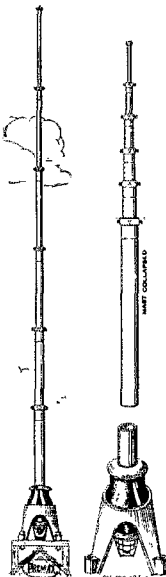

Premax Products

Division of Chisholm-Ryder Co., Inc.
3852 HIGHLAND — NIAGARA FALLS, N. Y.

SEND FOR SPECIAL ANTENNA BULLETIN

FOR SALE BY A.R.R.L.

STATION OPERATING SUPPLIES;
LOGBOOKS, RADIOGRAM BLANKS
DELIVERY CARDS

Full Details on Page 101

Improve Your Rig with Ready-to-Use Transmitter and Relay-Rack Cabinets at Low Cost

Your transmitter and relay rack cabinets have a smart one-piece appearance and new durability when you use any one of the many LeFebure models. Completely welded construction replaces all bolts. Your cabinets are shipped erected . . . ready to use.

Thousands of users are proud of the modern design and improved features of LeFebure cabinets. Custom-built cabinets to your specifications are a specialty with LeFebure. Model for every purpose at low cost.

Write today for complete details and low factory prices!

LEFEBURE CORPORATION MFRS.
Cedar Rapids, Iowa, U. S. A.

Standard Frequency Transmissions

Date	Schedule	Station	Date	Schedule	Station
Oct. 7	A	W9XAN	Nov. 4	A	W9XAN
	A	W6XK		A	W6XK
Oct. 14	BB	W6XK	Nov. 11	BB	W6XK
	A	W9XAN		A	W9XAN
Oct. 15	BX	W6XK	Nov. 12	BX	W6XK
Oct. 16	C	W6XK	Nov. 13	C	W6XK
Oct. 21	A	W6XK	Nov. 18	A	W6XK
Oct. 28	A	W9XAN	Nov. 25	A	W9XAN
	B	W6XK		B	W6XK

STANDARD FREQUENCY SCHEDULES

Time (p.m.)	Sched. and Freq. (kc.)		Time (p.m.)	Sched. and Freq. (kc.)	
	A	B		BB	C
8:00	3500	7100	4:00	7000	14,000
8:08	3600	7100	4:08	7100	14,100
8:16	3700	7200	4:16	7200	14,200
8:24	3800	7300	4:24	7300	14,300
8:32	3900		4:32		14,400
8:40	4000				

Time (a.m.)	Sched. and Freq. (kc.)
	BX
6:00	7000
6:08	7100
6:16	7200
6:24	7300

The time specified in the schedules is local standard time at the transmitting station. W9XAN uses Central Standard Time, and W6XK, Pacific Standard Time.

TRANSMITTING PROCEDURE

The time allotted to each transmission is 8 minutes divided as follows:

- 2 minutes—QST QST QST de (station call letters).
 - 3 minutes—Characteristic letter of station followed by call letters and statement of frequency. The characteristic letter of W9XAN is "O"; and that of W6XK is "M."
 - 1 minute—Statement of frequency in kilocycles and announcement of next frequency.
 - 2 minutes—Time allowed to change to next frequency.
- W9XAN: Elgin Observatory, Elgin National Watch Company, Elgin, Ill., Frank D. Urie in charge.
W6XK: Don Lee Broadcasting System, Los Angeles, Calif., Frank M. Kennedy in charge.

WWV Schedules

EACH Tuesday, Wednesday and Friday (except legal holidays), the National Bureau of Standards station, WWV, transmits with a power of 20 kw. on three carrier frequencies as follows: 10:00 to 11:30 A.M., E.S.T., on 5000 kc.; noon to 1:30 P.M., E.S.T., on 10,000 kc.; 2:00 to 3:30 P.M., E.S.T., on 20,000 kc. The Tuesday and Friday transmissions are unmodulated c.w. except for 1-second standard-time intervals consisting of short pulses with 1000-cycle modulation. On the Wednesday transmissions, the carrier is modulated 30% with a standard audio frequency of 1000 c.p.s. The standard musical pitch A=M440 c.p.s. is also transmitted from 4:00 P.M. to 2:00 A.M., E.S.T., daily except Saturdays and Sundays, on a carrier frequency of 5000 kc., power 1 kw., 100% modulation. The accuracy of the frequencies of the WWV transmissions is better than 1 part in 5,000,000.



Aerovox Corporation has just made available a new line of silvered-mica condensers for applications requiring high stability.

U. S. Auto Alarms
Approved by F.C.C.

Mackay type 101-A and Radiomarine Model AR-8600 are described in minute detail with complete operating instructions. Circuit diagrams and photographs.

ELECTRON TUBE

Various types, characteristics and applications, explained by Robt. Kruse, internationally known expert and radio engineering and technical editor.

Vacuum Tube Amplifiers and Oscillators

Class A and B audio amplifiers; Class B and C radio frequency amplifiers; Oscillator circuits; etc., etc.

Modulation and Modulation Analysis

Classification of systems and full explanation of each. Analysis by component method and by use of Cathode ray oscilloscope.

Latest Broadcast Transmitters

R C A types 100-H, 250-D, 5 KW type 5-D. Installations, adjustments, operation, and maintenance. High fidelity and new equalized feedback circuits.

Marine Radio — Telegraph Transmitters

and receivers — latest types. R M C A type 8003, 8006, 9007 transmitters and 8503 and 8504 receivers. Mackay type 131-A and 142 transmitters.

F.C. C. RULES and REGULATIONS

covering broadcast, ship, aviation, and police services. All important radio provisions of Communications Act.

DUTIES of the Radio Operator

at ground stations of commercial transport companies. Operation, adjustment, maintenance of transmitters and receivers and radio beacon receivers.

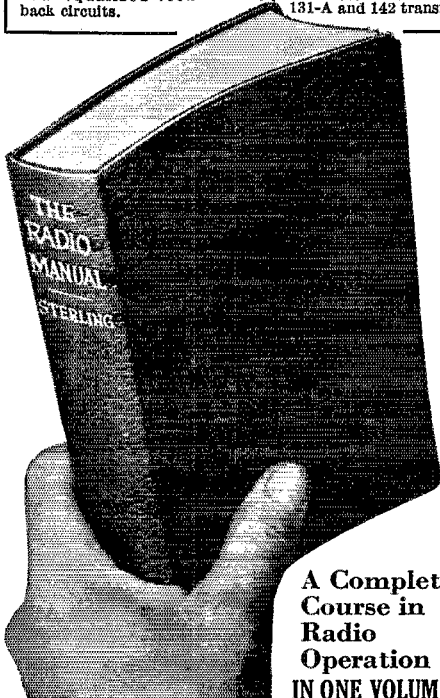

A Complete Course in Radio Operation IN ONE VOLUME

Enables You to Qualify for Gov't License as Operator or Inspector

20 Big Chapters Cover:

Microphones of all types — Radio and Audio Frequency Measurements — Antenna Resistance Measurements — Theory, Operation and Use of Radio Range and Marker Beacons (localizers) — Landing Beams including Lorenz System of Instrument Landing — System of Blind Landing developed by the U. S. Bureau of Standards experts — Radio Direction Finders (RCA and Kolster types with description of apparatus, maintenance, and service instructions) — Bellini-Tosi System — Ultra-high Frequency Police Transmitters and Receivers and Details of police communication systems — All Important Radio Provisions of the Communications Act of 1934 as amended effective 1937 — General Radio Regulations Governing Distress Signals.

This is just a hint of the vast amount of information packed into this great book. It is essential to every student, operator, and inspector.

EXAMINE IT FREE!

This is the Revised 1938 Edition of "The Radio Manual." 1000 pages, hundreds of illustrations. Bound in Flexible Fabrikoid. The coupon brings the volume for free examination. If you do not agree that it is the best Radio book you have seen, return it and owe nothing. If you keep it, pay the price of \$6.00 in easy installments.

Latest 1938 Data!

A complete revision, of this standard handbook, greatly enlarged, up to the minute. Complete information covering the entire field of Radio — all arranged for ready reference.

THE RADIO MANUAL

A Handbook for Students, Amateurs, Operators and Inspectors

Here's the only complete Handbook for students, amateurs, operators, and inspectors. It covers the entire field of radio in 1,000 pages with hundreds of illustrations and diagrams. It is actually a complete course of training in radio operation and a complete reference book for everyone in the field. It gives instantly the answer to every question about principles, methods, and apparatus of radio transmitting and receiving.

New Information

Never Before Available

This new edition is packed with up-to-the-minute information much of which is available in no other book and all of which is essential to any man whose work or hobby is radio in any of its branches.

Prepared by F.C.C. Expert

The author, G. E. Sterling, is Assistant Chief, Field Section, Engineering Dept., Federal Communications Commission and nationally known as an outstanding authority.

Sent on Approval

Mail This Coupon Today!

D. VAN NOSTRAND CO., 250 Fourth Avenue, New York
Send me on approval THE RADIO MANUAL. Within 5 days after I receive the book, I can return it and owe nothing. If I keep it, I will send you \$2.00 as first payment and I will pay \$2.00 monthly thereafter for 2 months — \$6.00 in all. (5% discount for cash.) (QST 10-38)

Name.....
Address.....
City..... State.....
Reference.....
Address.....

FOR FREE CATALOG of best books of practical instruction and technical information, check here. If you do not want The Radio Manual cross out paragraph above.

(Continued from page 105)

turned from a trip East and is all set for renewed activity on 3.5 Mc. NHZ is going to Port Arthur. QDL likes 7 Mc. EXH keeps LaCrosse on the map on 3.9-Mc. 'phone. ZTP is new O.R.S. in Milwaukee. The annual M.R.A.C. picnic was a huge success as usual. ONI finds he can modulate plates of final easier than the final plate supply. PSC has new "Breting 9" receiver. PQY is building clubhouse on his premises. QXZ builds rigs for hams around Superior. WYT gets on occasionally. RJB is heard now and then on c.w.

Traffic: W9SJT 2. (May 16-June 15th: W9ZTO 7.)

WEST GULF DIVISION

NORTHERN TEXAS—SCM, Lee Hughes, W5DXA—EOE has new rig on the air, 6L6 TT, 807, P.P. T20's, P.P. 838's. ECE has a pair of TZ40's Class B. CVA, recently of OK city, is now in Fort Worth at 1508 N. 5th St. Welcome to this section, Bill, EES has new RK48. FNP is adding 6L6 stage to his osc. DNE is on 7 and 3.5 Mc.

Traffic: W5DXA 9 EOE 5 EZY 2.

OKLAHOMA—SCM, Carter L. Simpson, W5CEZ—CEZ received temporary appointment as Alternate Section Control for Section 8, N.C.R. "Mert" of FSK is back from furlough and is making schedules again. FBI erected a new antenna system and is fully equipped to operate on Naval Reserve frequencies of 2484 and 2792 kes. DAK completed training course for Radioman 2nd Class in Naval Reserve. Guinn, who has been in charge of FOM, is going to Ft. Monmouth to radio school for nine months. HAR is getting some nice results with a 6L6 job on 3.5 Mc. KZ and EGQ enjoyed the last O.R.S./O.P.S. Party. FDQ applied for O.P.S. GAQ is now running 270 watts to a pair of T-55's. FSK was QSO AJY and the latter broke in and said he would have to QRT as his house was on fire; he hasn't been heard since! AIR reports his transmitter is completely dial controlled from the operating position. Now is the time to get into the swing for a big year. There is opportunity for all in the A.A.R.S., N.C.R., O.R.S., O.P.S. and trunk line work. Let's make it a big season for the Oklahoma Section.

Traffic: W5CEZ 200 FSK 83 DTU 39 FOJ 13 FBI 21 DAK 6 FOM 5.

SOUTHERN TEXAS—SCM, Dave H. Calk, W5BHO—OW reports DLZ on maneuvers. DWN will arrange schedules again after maneuvers. MN looks for big A.A.R.S. season this fall and is handling some overseas traffic direct. FDR built an 80-ft. tower. GUY would like to get in traffic net this season. EWZ worked K4EVD for country number 22. The Kingsville Radio Club spent a week-end at Lake Corpus Christi, near Mathis; the portable rig using push pull 616's was operated under the call FNL, the club call; those present were OI, EYR, FTM, GBH, GUW, FGL, ERC and GGV, who claims to be the only 15-year-old ham in Texas. FTM needs Vermont, EYR needs Idaho and FGL needs Nevada for W.A.S. GUW has FB new rig on 7 and 14 Mc. HBO and HHL are new hams in San Antonio. FAR is sporting new National NC101X receiver. MN has new National NC44 (for his kid, he says). AX had a serious operation; hope you recover soon, OM, and get back on the air. The following El Paso hams report having rotary beams: CFI, CYS, GYM, HEG, GJS, GQD, EZS and EHK. DYZ reports hearing DX signals on 56 Mc. AEP is on 7 Mc. with new Zepp and new receiver. HCC and EGI sport new receivers. CWW reports good DX on 14 Mc. DE and DVL have new QTH. GDP is working in broadcast station in Roswell, N. M. GQD rebuilt rig for 28 Mc. FGM is rebuilding. CGI is building 28-Mc. rig. HEG works 7-Mc. C. W. and 28-Mc. 'phone. GHU works 14-Mc. 'phone. AFS is on 28 Mc. AFN is on 7, 14 and 28 Mc. FOH is building new rig for 28 Mc. GMW is increasing power. FRK worked OA6A using a 6L6 crystal oscillator. FOK is building new kw. rig. CVQ-WLJU is building bigger and better portable to operate on special A.A.R.S. frequency 6990 ke. for emergency.

Traffic: W5OW 1028 MN 500 CVQ 54 FDR 24 CWN 3 GUY 2 DWN 2 (WLJX 110).

ROCKY MOUNTAIN DIVISION

COLORADO—SCM, Glen Glascock, W9FA—ZDZ runs high honors for traffic during the dog days with "Buck," WVB, running a close second in spite of the convention preparations. ZDZ is all tangled up in a 3.5- and 7-Mc. Net with some of the west coast boys on trans-Pacific traffic, and is fighting desperately for a good eastern outlet. "Chas" was visited by MKN, ESA and NFO. ESA and MKN made a vacation tour of the state during the month and visited a

number of the Colorado gang, taking along a portable built by ESA. VGC finally made W.A.S. with the help of ZEF in clicking with Salt Lake City. 5GAR/9 operating in the vicinity of Denver is really getting results on 28-Mc. portable. SEX is back in Ft. Collins for a short spell.

SOUTHEASTERN DIVISION

ALABAMA—SCM, James F. Thompson, W4DGS—P.A.M.'s 4DHG, 4BMM. R.M.'s: 4DS, 4APU. The season of better conditions and more activity is in full swing, and now is the time to do something to justify your existence on the air. There is no better way to prove that you should be allowed to have a place in the already overcrowded radio spectrum than by taking part in some organized activity. The O.R.S.-O.P.S. appointments also identify you as progressive hams. A.A.R.S. appointment also identifies you with a select group of efficient operators. RS at Selma will be glad to hear from all interested in A.A.R.S. (Army Net) work, either 'phone or c.w. There is also open an R.M. appointment for South Ala. EUZ at Greenville is new O.P.S. FLS up in the TVA territory applied for O.R.S. and A.E.C. APU was among the Ala. gang at KB's hamfest. DHG gave FAZ O.P.S. test. He reports two new calls in Mobile as a result of the M.R.C. school: FMH and FMI. The M.R.C. lost another valuable member via the moving route; he is EGU, who becomes Chief Supervisor of Telephones for the Coast Guard, stationed at Washington, D. C. DHG divides time between 1.75-, 3.9- and 14-Mc. 'phone. EQM has W.A.C.ed, but needs card from Asia; he has worked 40 countries since getting ticket in Feb. EQM's father has operator's ticket now, and he operated EQM also. FOT is new call at Langdale; he is the youngest ham in the "Valley," being 15, and has 6L6 "Ti-Tex" on 7 Mc. CWX stays on 28- and 14-Mc. 'phone. FL at Riverview is back after absence of long time with 6L6 on 7 and 3.5 Mc. ZS has the fever again; how many remember his old 3.5-Mc. band, 'phone? FOS, new at Samson, uses 801's in final with '46 mod. and has RME. EEU was visitor at WMPM. ZI has new 14-3.9-Mc. 'phone with tens. EBL works KB cross-band daily at noon. It's about time for the noon gathering each day on 3.9 and 1.75 Mc. EFR moved to new part of town. BLG has a new shack that's a honey; he also has 14-7-3.5-Mc. band-switch rig going. FMR, a new call, has P.P. 6L6 final. KF and FMR took N.C.R. cruise to Mexico and Cuba. EFR took vacation in Winslow, Ariz., and Hollywood, Cal. BHB has PR16 and is building rig for camp on the lake. WC is only active 3.9-Mc. 'phone in B'ham. BYK, AUP, AP and DGS share 3.9 Mc. in Mtgy. ECF says that General beam is really something. HB is gathering parts again. AUP has a new location which is FB for ham work. There will be held Sunday, Oct. 2nd, from 2 to 6 p.m., another of those Alabama QSO Parties. The rules will be spread over the air. Five points are sure to be given for each O.R.S.-O.P.S., R.M., P.A.M. or Director or the Alt. or Asst. Director or the S.C.M. worked. Pass the word along and let's have everybody on, 73-jim.

EAST FLORIDA—SCM, Lewis A. Connolly, W4DVO—Assistant SCM, Forrest W. Dana, W4AGR, N4FML, R.M.: 4COB, P.A.M.: 4DDB. DZT is trying for DX on 56 Mc. EPF is contacting home via SELN. DVB is visiting in N. Y. FOD is new ham in St. Pete. FJQ, also newcomer, is on 7 Mc. at Bradenton. EEF returned to Clearwater from Ohio by hitch-hiking! ACZ and CBR visited DDB in Deland. ASR is back on Knights of Kilocycles on 3.9 Mc., after trip with XYL to Key West. FAG, in Indiana for summer, sends 73 to friends. ERU is active on all bands, using TZ-40 final with 100 watts input. EGR changed QTH to Mims, Fla. EZX, COV, EFK and EMF are now looking for profitable spot to hang up their new Telegraph 2nd tickets. EBP advises there are many active hams around Jacksonville on 7 Mc., viz.: CEO, FAN, FDA, FNP, PI and BFR. DPT visited CM2ON and CM2BJ while in Habana. CO2JM, Justo Mahiay Rivas, spent vacation visiting Florida and U. S. A. for first time; JM was Amateur Technical Adviser of Cuba, at Habana Conference. CEO and FAN are roommates, and alternate shifts in working DX on 7 Mc. EPV received his W.A.S. certificate. DCZ received VK/ZL Contest certificate as winner in W4 District; score, 74 contacts, 5150 points; this was sixth in scores submitted by other districts. Congrats, Julian. EGL is studying television with an eye to the future! DWI visited Tampa and St. Pete hams and recently was heard on 3.5 Mc. Well, fellows, a few more reports will help, and don't be too brief! 73.

Traffic: W4DVO 43 DNA 114 COV 12 DDB 4 EUN 2 AGR 42 DWU 31.

Looking for a ham station to visit while driving along the road, W8KQZ spied a sign reading "W9RMS," and turned in to give the mystic pass word for a visit. The OM who came to the door, however, "no spik English."

It developed that the sign had been made with thin paint and part of the second letter had run.

The sign was designed to advertise fish bait!

Sulphur Candles and Radio Equipment

In closing my home for a short time my wife decided to burn a few sulphur candles as a moth-proofing remedy. Upon returning a few days later, I looked at my radio equipment. It looked like something that had been lying on the bottom of the ocean for years! My new receiver had lost its bright finish. The nickel trimmings were all tarnished, the copper was black, and the brass was green with tarnish. I rubbed and polished but found it almost impossible to get it back to the original newness. I was sick.

Then came headache number two. I turned the receiver on and found that it didn't seem to operate as well as before. I operated the crystal and selectivity switch, but there was no evidence of contact. Many of the switch contacts inside the receiver were inoperative. The sulphur fumes had reached them and corroded the points.

In conclusion, I much prefer the moths—they only eat garments. Such a misfortune as this eats your heart!

—Irving J. Gallagher,
700 Franklin St., Elizabeth, N. J.

Correction

Fig. 2, page 29, *QST* for August should show a connecting line between the output of the 30-henry choke and the connection of *RFC* and *R₂*. In addition, the list of parts specifications for this circuit was omitted, and is given below:

- C₁—260- μ fd. variable, single-spaced.
- C₂—25- μ fd. variable, single-spaced.
- C₃—100- μ fd. variable, double-spaced.
- C₄—0.001- μ fd. fixed mica, 600-volt.
- C₅—0.0001- μ fd. fixed mica, 600-volt.
- C₆—0.02- μ fd. fixed mica or paper, 600-volt.
- R₁—50,000-ohm, 2-watt carbon.
- R₂—75,000-ohm, 100-watt, slider type.
- R₃—50,000-ohm variable.
- T₁—600-0-600 volts at 200 ma., 2½ volts at 10 amperes, 5 volts at 3 amperes, and 6.3 volts at 3 amperes. Suitable data for grid and plate coils are as follows:

For 3.5-Mc. output:

- L₁—35 turns No. 18 enameled wire, close-wound, tapped 5 turns each side of center.
- L₂—30 turns No. 18 enameled wire, close-wound.

For 7-Mc. output:

- L₁—17 turns No. 18 enameled wire, tapped 3 turns each side of center.
- L₂—17 turns No. 18 enameled wire.

For 14-Mc. output:

- L₁—9 turns No. 14 enameled wire, tapped 2 turns each side of center.
- L₂—12 turns No. 14 enameled wire.

For 28-Mc. output:

- L₁—6 turns No. 14 enameled wire, tapped 1.5 turns each side of center.
- L₂—7 turns No. 14 enameled wire.

New Data on Direction of Wave Propagation

AT THE recent I.R.E. Convention in New York Mr. C. B. Feldman, of Bell Telephone Laboratories, presented a paper disclosing some observations on direction of wave travel which will be of great interest to the many amateurs who work DX. Previous work in this field had shown that waves almost always travel along great circle routes, the greatest departure being of the order of 5 degrees or so. It now develops that under certain conditions the waves may arrive from directions as far as 90 degrees from the great circle route!

The work has been carried on over a period of a year or so using receiving antennas having steerable characteristics in the horizontal plane. Observations were made on two short-wave stations of the B.B.C. located near London: GBC with a directive antenna focussed approximately on New York over the great circle route, and GBS similarly directed toward South Africa. Under normal conditions, best signals will be received with the receiving antenna directed toward London to receive GBC, while the signal from GBS will be poor because it radiates comparatively little power toward New York. This is always the case during the daytime and with quiet magnetic conditions.

It has been found, however, that on many occasions just before and just after a magnetic storm, and when transmission is partly or wholly through darkness or a sunset zone, the signals from GBC will be weak and fade badly with the receiving antenna directed toward London. At the same time, a stronger and much steadier signal will be received from GBS when the receiving antenna is directed somewhat south of east toward South Africa, practically at right angles to the normal line of transmission. During a particularly severe storm in the early part of this year, the great-circle signal was inaudible while a readable signal was coming through from the South African direction. With quiet magnetic conditions, the signals from the south often can be heard at night, but are not nearly so strong as those coming over the usual route. The effect, however, is definitely present.

No explanation for the peculiar behavior of the signals is being offered at present. A tentative hypothesis has been advanced, but since there is no experimental evidence confirming it, the authors prefer not to have it published at the moment.

In the future, be a bit careful about labelling a new piece of DX "phoney" if your rotary beam shows him to be in the direction of Africa while he's telling you his location is some off-the-map European country!

—G. G.

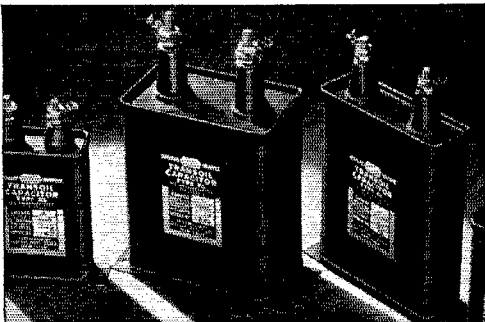

TRANSOIL

for transmitting

**HIGHEST QUALITY
OIL CAPACITORS**

Write for Catalog 2-X
listing complete lines

TRANSOIL—SOLAREX—TRANSMICA

SOLAR
MFG. CORP.



599 BROADWAY
NEW YORK CITY

LET US BUILD IT FOR YOU

Give your next piece of equipment a rugged professional appearance by availing yourself of our modern laboratory and shop facilities.

Write us your requirements, we will furnish estimate, together with photos of our work.

Speech, modulator, RF & AF units. Monitoring equipment, compressors, limiters, power supplies, relays, etc.

Receivers aligned and microvolt sensitivity reports furnished. QST designs made up.

FEIGNER TECHNICAL ASSOCIATES

525 Woodward Avenue 22 years in radio Detroit, Michigan

COMMUNICATIONS ENGINEERS!

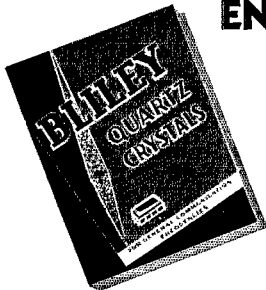

Be sure to get a copy of the new Bliley Catalog describing crystals, holders and ovens for all services other than amateur. Of special interest are

the high frequency crystal units, types MO2 and MO3, for frequencies from 7.5mc. to 30mc.

Write for your copy today—just ask for catalog G-10

BLILEY ELECTRIC CO., ERIE, PA.

Refinements in Combination Exciters

(Continued from page 41)

condensers are used, depending on the amount of capacity necessary to tune the circuit to resonance. At first glance, it would seem that this capacity in each case would be too small compared to the 25- μ fd. maximum capacity of the parallel band-spread condenser; however, the combined capacity of the tube, circuit, and effective capacity of the coil is in many of the tanks almost sufficient to serve alone as the fixed or padding capacity.

Parallel feed is used in all of the oscillator and doubler plate circuits. This feature leads to neither an increase of efficiency nor one of economy, but is incorporated in this unit to place the fixed tanks at ground potential. If provision is made in a set of this sort for insulating the band-spread condensers and the padder condensers, a small saving will result from use of series feed in these stages. Another way to arrive at this more desirable circuit arrangement is use of blocking condensers of 0.001 μ fd. or greater capacity between the B+ connection of the coil and the rotor connections of the condensers. In this way, the 300-volt plate potential is placed across the condensers, but this value, added to the r.f. voltage developed by such stages, is insufficient to cause sparking in single-spaced condensers.

R.F. EXCITER LAYOUT

The sketches of Fig. 3 show a more open arrangement of the r.f. equipment previously discussed. A drum or worm gear dial is used, so that the ganged band-spread condenser may be mounted parallel to the front panel. Removal of speech amplifiers and such additional power supply apparatus as is made necessary by the incorporation of audio equipment makes possible a much more accessible type of construction. Aside from the band switch and crystal switch, with associated flexible and rigid shafts and couplings, all of the below-chassis space is saved for tube and crystal sockets, resistors, small condensers, and wiring. With this layout all connections are confined to the sub-panel area except direct leads through the chassis to the tuning condensers and the plate of the 807 tube.

In order to make the construction of the fixed-tuned exciter tanks less expensive, a shield box of honeycomb construction may be made of thin sheet aluminum. A single variable condenser and a coil either permanently mounted or plug-in may be used for each tank. This may be assembled on a bracket of aluminum sheet two inches wide, bent at a right angle at the chassis for mounting and again at a right angle in the same direction at the top to provide a horizontal surface for the usual single-hole condenser mounting. Such an assembly, with coil mounted on the vertical portion of the bracket beneath the condenser, permits short, direct wiring and easy accessibility for adjustment. A sketch of the details is shown in Fig. 4.

"You can't beat a Harvey UHX-10!"

**THE BOWDOIN KENT'S ISLAND EXPEDITION
BAY OF FUNDY**

VE1IN

Headquarters Address:
Thomas Gross - W1JZM
Brunswick, Maine, U.S.A.

TRANSMITTERS:- 1000 watt phone on 14,285, 4797.5, and 3885 Kc. - Harvey UHX-10 on 3.5 and 28 mc. aboard "Scientist"; POWER SUPPLY: 2 gasoline driven plants with 5 kw output; RECEIVERS: RME-69 with DB-90 pre-selector, Masterpiece V, and SW-3. VE1IN has a special frequency assignment, 4.8 mc., for bird song recording and rebroadcasting purposes. A 4000 foot terminated rhombic antenna is used on this frequency.

To Radio W1JZM We are pleased to verify PHONE SIGNALS
Your signals RST-Q4-R9 of our station on 3888Kc. Remarks You
can't beat a Harvey UHX-10!

Ops, W1JZM "Tom"
W2JKE "Fred"
W1KJU "Murray"

Both VE1IN and W1AUJ were using Harvey UHX-10 transmitters. A proof that low power properly used can really go places. The UHX-10 is not only a good rugged station transmitter, but also compact and light for portable operation. Don't neglect this transmitter because of its low power — write to Harvey Radio Laboratories, Inc., 25 Thorndike Street, Cambridge, Mass., for complete information. Export division, 25 Warren St., New York City. Cable: "Simontrice."



UHX-10 TRANSMITTER

AUTOMATIC SENDER \$12.50
Sends 2 to 70 words a minute. Entirely automatic. Speeds \$13.50 west of Denver
reception. Good practise medium for beginners.

HIGH SPEED RELAYS \$4.50 to \$10
High-speed Keying, Photo-Cell Amplifier and Sensitive. Only 1" wide
and 3/4" high. Available in 6, 25, 50, 100, 150 volts.

MERCURY VAPOR KEYS \$7.00
Eliminates clicks

If your dealer can't supply you, write us

Gardiner-Levering Co. Haddon Heights
New Jersey, U. S. A.

SICKLES COMPONENTS FOR THE KINN EXCITER

Exact duplicates of the specially designed coils and other Sickles components used in the exciter described by T. P. Kinn, W1CC, in September QST, are available to amateurs at moderate cost.

For full particulars, write

THE F. W. SICKLES COMPANY
300 Main Street Springfield, Mass.

● RADIO OPERATOR'S COURSE ●

TELEGRAPHY
TELEPHONY
AVIATION
TELETYPE
TELEVISION
TRANS RADIO
PRESS



PRACTICAL
EXPERIENCE
STUDIO —
TRANSMITTER —
ANNOUNCING
TYPEWRITING

Port Arthur College advertises primarily to Radio Amateurs and the training is too technical for the average student who has not selected Radio as his life's work. The opportunities for positions and advancement are unlimited for men who are interested in Radio and who plan to make this their career and are willing to make the sacrifice and effort necessary to master the training. P. A. C. maintains strict collegiate rank — only high school or college graduates are eligible for enrollment.

If interested in details about Radio Course, write for bulletin R

PORT ARTHUR COLLEGE ■ **PORT ARTHUR (World-known port) TEXAS**

INDISPENSABLES

✓ *your receiver*

✓ *your transmitter*

✓ *your F.C.C. licenses*

✓ **your LICENSE MANUAL!**

It's against the law to operate an amateur radio station without the required federal licenses for station and operator. The maximum penalty for so doing is a \$10,000 fine and two years in a federal penitentiary.

That's the broad basic picture. But within the scope of the federal licensing machinery are many detailed regulations, the violation of any one of which can lead to suspension, cancellation of licenses, or even fines or imprisonment. These regulations change frequently, in step with the rapidly developing art of radio.

There is only one way for the amateur to keep at his finger tips these changing legal requirements—short of maintaining his own Washington legal bureau. That is to keep the latest edition of the Radio Amateurs License Manual in the shack at all times. New editions always contain the latest regulations—and when a new edition appears it means that changes in federal regulations have made its predecessor obsolete.

WE ARE NOW SUPPLYING THE EIGHTH EDITION

TAKE A LOOK AT YOUR COPY!

25 cents postpaid

AMERICAN RADIO RELAY LEAGUE

West Hartford, Connecticut, U. S. A.

One important point to observe is the location of the e.c. oscillator tuning condenser at the extreme right-hand position in the layout of Fig. 3. This means that if the dial is to be accurately and dependably calibrated, a rigid shaft assembly must be provided, as previously discussed.

The crystal switch and the band switch are placed so that short, direct connections are made possible. This is not only good practice from the high-frequency electrical standpoint, but also aids in clearing away the maze of wires which would result if a haphazard layout of parts were followed. The crystal switch is immediately below and to the rear of the 6V6 socket, so that the length of leads from any of the five crystal sockets is limited to a few inches. The band-switch is placed so that the first section is beneath the first doubler grid terminal, succeeding sections are below the following doubler grid terminals, and the final two discs of the switch are below the 807 and associated high-frequency tanks. The 10-meter 807 plate tank is separated from the 10-meter doubler tank by the 20-meter amplifier assembly in order to prevent coupling between the doubler and amplifier.

In the circuit diagram of Fig. 1, a single-pole five-position switch is shown connected so that it selects the output of the e.c. oscillator or one of four crystals, placing the circuit chosen in contact with the grid of the following stage. This system is perfectly satisfactory, if it is carefully constructed and the tanks are carefully tuned to eliminate simultaneous excitation on two frequencies from crystal and e.c.o. Another method of using one switch for the purpose of selecting a crystal and for that of changing from crystal frequency control to e.c. oscillator is shown in Fig. 5. Here, a single-disc switch of the two-pole, six-circuit non-shortening type, costing less than fifty cents and occupying very little space, is used. One pole of this switch is connected to the grid of the 6V6 stage and five of the six corresponding switch points are connected to five crystals. The other pole of the switch is connected in the screen supply circuit of the e.c. oscillator, so that in the sixth position (the position of no crystal connection) the e.c. oscillator is made operative. The major feature of this arrangement is absolute freedom from mixing of the e.c.o. output in the crystal oscillator and freedom from an undesired signal when monitoring the output of the unit.

There is little to be said on the subject of power supply for an r.f. exciter-transmitter of this sort, except that it should be thoroughly filtered and should be nearly free from voltage change resulting from keying. The power supply may well be included in the r.f. unit, especially if a husky transformer and set of chokes which are not inclined to set up strong mechanical vibrations are used. For a layout such as that shown in Fig. 3, the current rating of the transformer and chokes should be at least 250 ma. A good swinging choke should be used as the input choke, and the windings of chokes and transformer should have low resistance. As the four doubler stages take a constant plate current, with or without excitation, and as this value is greater than the current for

THE RADIO AMATEUR'S LIBRARY

Many requests are received for copies of this list so we again present it in *QST* in its complete form — to give a comprehensive picture of our publishing services to the amateur.

No.	Title	Price
1.	QST	\$2.50 per year*
2.	List of Stations	Pre-war Out of Print
3.	Map of Member Stations	Pre-war Out of Print
4.	Operating an Amateur Radio Station	Free to members; to others 10c
5.	The Story of The A.R.R.L.	Out of Print See No. 13
6.	The Radio Amateur's Handbook	\$1.00**
7.	The Log	35c each, 3 for \$1.00
8.	How to Become a Radio Amateur	25c
9.	The Radio Amateur's License Manual	25c
10.	Hints & Kinks* for the Radio Amateur	50c
11.	Lightning Calculators:	
	a. Radio (Type A)	\$1.00
	b. Ohms Law (Type B)	\$1.00
	c. Wire Data (Type C)	50c
	d. Decibel (Type D)	50c
	e. Parallel Resistance — Series Capacity (Type E)	50c
	f. Resistance Calculator (Type F)	50c
12.	Amateur Radio Map of the World	\$1.25
13.	Two Hundred Meters and Down: The Story of Amateur Radio	\$1.00
14.	Building an Amateur Radiotelephone Transmitter	25c

* In the United States and Possessions and Canada. Other Countries \$3.00 per year.

** Postpaid in Continental U. S. A. — \$1.25, postpaid, elsewhere

(SPANISH EDITION HANDBOOK — \$1.50, Postpaid)

THE AMERICAN RADIO RELAY LEAGUE, INC.
West Hartford, Connecticut

New RCA 3" Oscillograph Brings You Many New Fea- tures at a Popular Price!

This oscillograph, the newest addition to the No. 150 Series of RCA Test Equipment, includes many new features. All the controls, including the spot centering controls are on the front panel. Smaller size and lighter weight greatly increase its portability. And its new styling and finer performance make it unusually attractive. You'll agree it's a bargain!

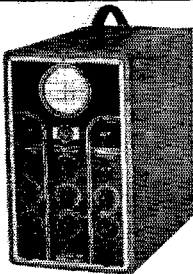

SPECIFICATIONS

Radio tubes... 1 RCA 906 (improved type), 2-6C6, 2-80, 1-884—Total 6. Sensitivity... without amplifier—20 volts (RMS) per inch deflection with amplifier—0.5 volt (RMS) per inch deflection; Amplifier: Response... Flat, 20-90,000 cycles—Gain 40; Timing axis, 15-22,000

cycles. Controls... Front panel for all operations, including centering; Power Supply, 110-volts, 50-60 cycles; Input power... 50 watts; Dimensions... H 15", W 8", D 14"; Finish... Blue-gray baked wrinkle lacquer—streamlined handle. \$63.95 Net. Stock No. 155.

Over 825 million RCA Radio Tubes have been purchased by radio users... In tubes, as in parts and test equipment, it pays to go RCA All the Way.

RCA presents the Magic Key every Sunday, 8 to 9 P.M., E.S.T., on the NBC Blue Network.



Parts

FOR PROFIT

RCA Manufacturing Co., Inc., Camden, N. J.
A Service of the Radio Corporation of America

RADIO

ENGINEERING, broadcasting, aviation and radio telegraphy and telephony, Morse telegraphy and railway accounting taught thoroughly. Engineering course of nine months' duration, equivalent to three years of college radio work. School established 1874. All expenses low. Catalog free. **DODGE'S INSTITUTE,** Day Street, Valparaiso, Indiana

Birnbach
ONE OF THE MOST
RESPECTED NAMES
IN RADIO

Respected because there is never any compromise with quality in Birnbach Products; because every one of the 3000 items in the Birnbach Catalog is guaranteed to satisfy; because for 17 years Birnbach has pioneered many new products such as Feed thru Insulators, Scrubbers, the new Solderless connection for test leads and prods, etc.

Before you buy parts to build your new rig Specify Birnbach!

A FEW BIRNBACH LINES

- Feed thru Standoff Insulators
- Standoff Insulators
- Cone Standoff Insulators
- 10 or 50 watt sockets
- Jacks, Plugs, accessories
- Test Prods and Leads
- E01 cable
- Stretchless Copper-weld Enamel
- Antenna wire or any of the 3000 other items listed in our catalog.

BIRNBACH RADIO CO.

145 HUDSON ST. **BIRCO** NEW YORK, N. Y.

which a bleeder would normally be provided, no such resistor is necessary. The output voltage of the supply should be 500 to 600 volts, and a common voltage-dropping resistor should be used for the oscillator stages and the four doublers.

AUDIO FREQUENCY STAGES

Two of the greatest difficulties with which 'phone operators are confronted in building and adjusting speech amplifiers and modulators are a.c. hum and r.f. feedback. Of the two, it is difficult to determine which has caused more headaches, or which of the two is most objectionable. Of course, there are different degrees of each trouble; the hum content in the modulation of a 'phone station may be any amount from an imperceptible degree to one which makes the speech barely audible, and likewise, one speech amplifier may be used with a comfortably large amount of audio voltage gain, while another is limited to a barely open gain control, thus requiring loud speech very close to the microphone for complete modulation.

A method of overcoming these obstacles to a great extent is an old one too seldom used: All-push-pull resistance-coupled speech amplifiers. Although this may give a first impression of being fearfully complicated and difficult in this time of low-output microphones requiring relatively high amplification, in reality it is no more complex than the circuits in present use. It is interesting to make a comparison between a simple but effective high-gain amplifier of the circuit shown in Fig. 2, and a high-gain arrangement making use of a resistance-coupled phase inverter.¹ In the latter, a pentode or high-gain triode is usually used as the first amplifier, with input direct from a crystal microphone (in many cases; velocity and dynamic microphones with high-impedance output transformer provision in others) to the grid of this tube. Frequently, this input tube is followed by a dual triode or a pair of triodes, one of which serves as a voltage amplifier, and the other of which acts as a phase inverter of no gain, thus simplifying the problem of driving push-pull stages without the necessity for a transformer. Reference to Fig. 2, page 40, *QST* for November, 1937, will show that little is gained in economy of apparatus required or in simplicity of construction by use of the single-tube-input phase-inverter circuit rather than one of push-pull stages throughout. Whereas the all-push-pull method requires a two-gang gain control, and additional grid and plate resistors and tube for the first stage, the amplifier with single-tube input requires decoupling circuits, careful by-pass of the cathode bias resistor, and careful selection of the resistors used as the voltage-divider supplying the grid of the phase-inverter tube.

While the merits of the all-push-pull speech amplifier may be briefly mentioned in a few short

¹ G. F. Wunderlich, "A Deluxe 100-watt C.W.—'Phone Transmitter with Band-Switching Exciter," *QST*, Nov., 1937.

T. M. Ferrill, Jr., "Compact Construction with High Power," *QST*, March, 1938.

"Put Your Signal Where You Want It When You Want It There"

THE NEW 1939 MIMS SIGNAL-SQUIRTER



The new 1939 Mims Signal-Squitter is really wonderful. Of course there isn't room here to describe its many important and unique features such as its new high-efficiency coupling system which makes it unbelievably easy to tune, its remarkable gain (twice or more the gain of previous models), its sturdy construction to withstand bad weather, its simple and reliable electrical rotating mechanism, and a hundred lesser points where our experience has taught us what to do and how to do it.

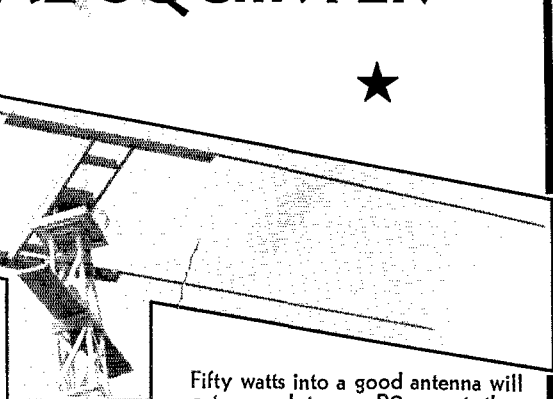

Fifty watts into a good antenna will get you a lot more R9 reports than a kilowatt into a bad antenna. To hop up your signal at the receiving end, use a really good antenna

Write for details on the new Mims 1939 Signal-Squitter. **Price 59.50 Complete**

MIMS RADIO COMPANY

M. P. MIMS—W58DB, P. O. Box 504, Texarkana, Ark.

RADIO COURSES

RADIO OPERATING: Prepare for Gov't License Exam. ● RADIO SERVICING: Including Short Wave ● AMATEUR CODE ● ELECTRONICS ● TELEVISION ●

Day and Evening classes—Booklet upon request

NEW YORK YMCA SCHOOLS

4 West 63rd Street, New York City

PRECISION CRYSTALS



Crystal Holder

Highest quality crystals, one inch square, carefully ground for frequency, stability and maximum output. Be sure of your transmitter frequency — use PRECISION CRYSTALS.

Crystals can be furnished with square holder as illustrated (fits G.R. type jacks) or with round holder to plug into tube socket. When ordering be sure to state the type holder desired. G.R. jacks to plug illustrated holder into—15c pair.

Low frequency drift crystals (Type LTC) supplied within 0.1% of your specified frequency and calibrated to within 0.03% are priced as follows: 1750, 3500 and 7000 kc. bands \$3.50 each. Holder \$1.00. (State type desired.)

X cut PRECISION Crystals carefully ground for maximum power supplied within 0.1% of your specified frequency and calibrated to within 0.03% are priced as follows: 1750, 3500 and 7000 kc. bands — \$3.00 each. Holder \$1.00. (State type desired.)

AT cut crystals for commercial use quoted on at your request. When ordering our product you are assured of the finest obtainable. Now in our ninth year of business.

PRECISION PIEZO SERVICE

427 Asia Street

Baton Rouge, La.

LOW COST STEEL ANTENNA TOWER

Used and Endorsed by
FEDERAL, STATE, COUNTY, CITY GOV'TS.,
FORESTRY, HIGHWAY PATROLS
and HAMS everywhere!

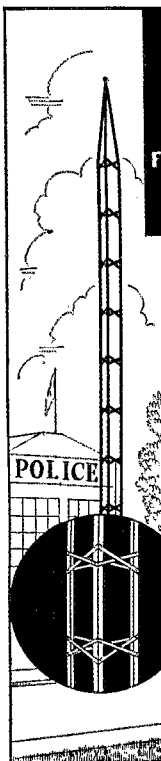

ONLY 60¢ PER FOOT Complete!

This remarkable low price is possible only because we produce many thousands of these towers each year for use with our Wincharger. Price includes necessary guy wires and tower sections of 10 or 20 ft. lengths with 5 ft. tapered stub top.

LIGHT, STURDY, RIGID

Thousands in use as vertical radiators and horizontal antenna supports. Scientifically braced. No points of undue strain. Both vertical angles and cross braces now hot dip galvanized.

SAFELY ERECTS TO 200 FT.

Quickly and easily erected, without skilled assistance, to heights of from 25 ft. to 200 ft. Enthusiastically used and recommended by police and broadcasters for thoroughly satisfactory service.

READ U. S. FORESTRY LETTER!

"Your tower was installed on Signal Peak, a Lookout Station on the Yakima Indian Reservation, at an elevation of 5,111 ft. above sea level. We have found the Wincharger tower 100% satisfactory and it has stood up under 70 mile winds, snow and ice which are severe at almost a mile up from sea level." Thomas L. Carter, Forest Supervisor, Office of Indian Affairs, U. S. Department of the Interior, Toppensish, Wash.

Order Direct From
WINCHARGER CORPORATION
Sioux City, Iowa

● THE ● SCOPE OF THE BOOKLET

"BUILDING AN AMATEUR RADIO TELEPHONE TRANSMITTER"

This booklet is addressed primarily to readers who have at least read our companion booklet, "How to Become a Radio Amateur," and have, perhaps, built a simple telegraph transmitter and receiver, have received their license, have acquired some skill and experience as a code operator, and who now feel the urge to explore the possibilities of radio telephony. These people should find this booklet the exact answer to their needs.

Absolutely the first requisite in either building or operating a 'phone transmitter is a solid understanding of what we are attempting to do when we accomplish voice transmission. Understanding the functions of the various parts, we shall avoid difficulties. The saddest thing in amateur radio is a 'phone amateur who does not understand the operation of his apparatus. The book begins, therefore, with a discussion of the principles involved and makes every effort to make this discussion perfectly clear so that the reader can easily make it a part of his own knowledge. It then goes on to the actual construction and operation of an inexpensive but efficient 'phone transmitter.

Priced at 25 cents per copy, postpaid

~~~~~  
**AMERICAN RADIO RELAY LEAGUE**  
**West Hartford, Connecticut**

sentences, this system must be used and compared in operation with other speech amplifiers to be fully appreciated. To begin with, ripple voltage of the plate supply to the amplifiers is applied to the plates of each push-pull stage simultaneously, and thus, if the stages are properly balanced, will be cancelled or effectively reduced at the first plate transformer in the series of stages. Audio feedback due to common power-supply voltage variations, while usually not appreciable in amplifiers having push-pull power stages, is similarly reduced in extent. In single-ended amplifiers the microphone, cord and plug, and the wiring of the first speech amplifier stages usually are susceptible to r.f. pickup from the strong transmitter field and lead to detection in the input amplifier tube, which in turn feeds the detected audio signal to the grids of the following amplifiers. The r.f. pickup of a push-pull stage, being more or less balanced in amount applied to the grids, will be detected in both input tubes, and the audio signal from this source, also, will at least be partially cancelled. Of course, the wiring at the input of these tubes should be shielded thoroughly just as though no suppression of the detected r.f. signal were provided, and in addition, an attempt should be made to keep the exposed wiring in such a position that both tubes will receive equal amounts of r.f. energy. The thorough shielding used for the speech input to the amplifiers of the set pictured is used not because of necessity for ordinarily acceptable freedom from r.f. feedback to the audio system, but to provide far more than the ordinary degree of freedom from this trouble, even with r.f. stages and audio stages combined in one chassis.

The practical advantage of the use of push-pull stages throughout the speech amplifier, then, is the fact that less audio filtering, less power supply filtering, and less r.f. filtering is necessary for operation of an all-push-pull system comparable to a similar system with single-tube input; or much more freedom from these commonly encountered troubles results from the same care in design and construction of a system using push-pull stages throughout.

The circuit of a high-gain speech amplifier and driver incorporating the push-pull input system is shown in Fig. 2. The shielded two-wire cable from the crystal microphone is terminated in a shielded three-circuit microphone plug, with shield grounded to the sleeve of the plug and the two-wire conductors connected to the plug tips. The jack which receives this plug, the r.f. chokes, and the grid resistors for the input stage are mounted in a small aluminum shield can. From this can, symmetrically-placed shielded wires make a short, direct path to the grids of the 6J7 input tubes. The latter are used because of the high amplification and low effective input capacitance. A single 6N7 tube is used for each of the succeeding stages, with the two triode sections in push-pull and the cathode grounded through a bias resistor with no cathode by-pass condenser.

The 2A3 tubes were selected for the fixed-bias power output stage because of their suitability

# GAMMATRON

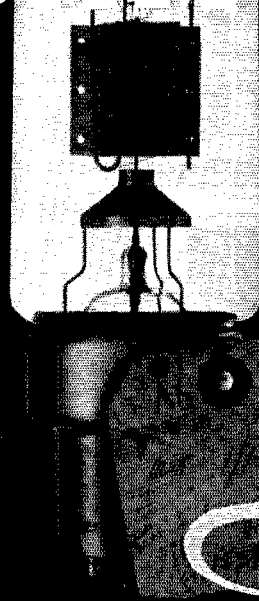

*15,280 hours*  
in actual operation

IN COMMUNICATIONS SYSTEM  
OF EASTERN AIRLINES INC.

LONG LIFE-LOW COST  
MEANS MORE  
WATT-HOURS PER DOLLAR



## DON'T BE MISLED!

Erecting a self-supporting vertical antenna on a rooftop is serious business. A cheap, flimsy product is a dangerous hazard to life and property. That is why ACE antennas reflect their design by competent structural engineers as well as skilled radio craftsmen, in their sturdy, attractive commercial appearance and excellent radiating qualities.

Already scores in use by commercial interests and discriminating amateurs . . . you too, can experience the satisfaction of a sound and efficient radiator that requires less than a square foot of roof space!

Prices are far below what you would expect to pay for a product of this quality. Order direct.

Type HF-20 — 33-ft. radiator . . . . . \$19.50  
(20-40-80-160 bands)

Type HF-10 — 16-ft. radiator . . . . . 13.50  
(10-20-40-80 bands)

Remit with order or COD on receipt of \$5.00 deposit

**ACE PRODUCTS CO.**

Terminal Sales Bldg. Seattle, Washington

Write for data on ACE beam antennas

## THE VALPEY CRYSTALS

**TYPE V5** — Mounted low drift crystal, holder molded from low loss material, plugs into tube socket. Within 5 Kc of frequency specified in the 1.7, 3.5 and 7 Mc. bands . . . \$4.80

**TYPE VM2** — Mounted X cut crystal, holder molded black Bakelite plugs into tube socket, within 5 Kc. of frequency specified in the 1.7, 3.5 and 7 Mc. bands . . . . . \$3.00

**TYPE VC2** — X cut crystal less mounting within 5 Kc of frequency specified in the 1.7, 3.5 and 7 Mc. bands . . . \$1.90

**TYPE VCH1 and VCH2** — Mounting less crystal. Machined from glossy black Bakelite; special pins for tube socket mounting or may be adjusted for G. K. jacks.

VCH1 for 1.7 and 3.5 Mc. crystals . . . . . \$1.00

VCH2 for 7 and 14 Mc. crystals . . . . . \$1.00

Complete descriptions and illustrations in our new catalog free upon request.

Valpey crystals may be purchased from your dealer or direct

THE VALPEY CRYSTALS, Box 321, Holliston, Mass.

## THE GOOD NAME

of Ken-Rad stands for the highest type of material and workmanship in radio tubes. You will be delighted by the performance of dependable Ken-Rad Tubes in your radio. They will increase the enjoyment of your favorite programs.



**Ken-Rad Radio Tubes**

KEN-RAD TUBE & LAMP CORPORATION - OWENSBORO, KY.  
Manufacturers of all types of radio tubes and Ken-Rad Electric Lamp Bulbs

# GOOD RESULTS DEMAND *Good Instruments!*

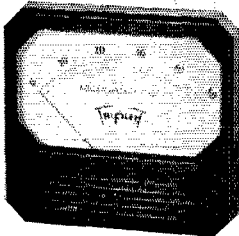

4" Modemistic Square Instrument . . . A.C. and D.C. All Popular Ranges

SELECT A  
**TRIPLET**  
18 STYLES  
2" to 7"

ROUND • SQUARE  
FAN OR TWIN CASES

**MOST MODELS AVAILABLE WITH FRONT or REAR ILLUMINATION**

Today's Most Modern Instruments. . . New methods and extremely accurate processes are embodied in Triplet instrument designs. The first considerations are for dependable accuracy, simplicity, and the best application of the fewest number of parts. Infinite care in every form is exercised throughout in Triplet's modern, fully air-conditioned plant under the supervision of engineers of long standing instrument building experience. This unique instrument setup is available to you as a most reliable, complete organization where full confidence may be had in valuing such products to your needs.

**ASK YOUR JOBBER OR WRITE FOR COMPLETE CATALOG**

Section 2510

**TRIPLET ELECTRICAL INSTRUMENT CO.**  
Bluffton, Ohio

College Standards

## ENGINEERING

Accredited Courses

Distinguished university faculty insures academic standards of instruction and scholarship. Accredited courses in Radio and Electrical Engineering parallel college curricula. Formal instruction based upon college textbooks. Credits transferable to colleges for advanced standing. Bulletin sent on request — Newton Institute of Applied Science, 2021-J Raymond-Commerce Bldg., Newark, N. J.

**HOME STUDY ON THE COLLEGE LEVEL**

# FASTEST WAY TO LEARN CODE

*Easy, Fascinating* — LEARN BY EAR to be a GOOD OP.



The New All Electric Master Teleplex Code Teaching Machine is exactly what thousands are looking for. No experience needed. Ideal for beginners — steps up WPM

for ALL Ops. There is no guesswork with Master Teleplex, because it records your sending in visible dots and dashes. You SEE and HEAR exactly how you are making your signals. You learn code the way you'll be using it — by SOUND. Complete course included at no extra charge. Used by many schools for teaching code. Low cost, easy terms. **MONEY BACK GUARANTEE.** Send now for booklet Q-10, no obligation. Post card will do.

**The "Ham" Special**

Standard Teleplex — a highly efficient code teacher using heavy specially prepared waxed paper tape, having two rows of perforations. Write for Free folder Q-10

We are the originators of this type instrument

**TELEPLEX CO.** 72-76 CORTLANDT ST. NEW YORK, N. Y.

for use as driver tubes for a Class-B modulator of appreciable power, and because of the fact that the tubes, with wide tolerance of load impedance, could be used with the Class-B driver transformer to plate modulate the 807 r.f. amplifier included in the r.f.-audio unit. With a maximum value of audio output exceeding 15 watts, and a maximum rated input power of approximately 40 watts for the 807 as modulated Class-C amplifier, the combination of 807 and 2A3 tubes makes an excellent 'phone transmitter of approximately 25 watts output.

Although a great amount of time and effort is involved in the construction of such units as described, the cost to the user is more than repaid in the operating satisfaction given by the flexibility and the assurance of proper operation of the completed assemblies.

## Rotary Beam Antennas

(Continued from page 48)

Reducing the thickness of the sections marked "C" to 1" x 2", will not change any of the other measurements, or the size of the bolts required, if the members are set up on edge. This will cut the weight down materially, without reducing the strength enough to be noticed. Unless this is done, the units "A" and "C" weigh thirteen pounds, while all the rest of the assembly, along with the necessary bolts, only weighs sixteen pounds. Further reduction in the weight of the central section may be secured by using redwood or pine instead of the oak for the "C" members, as was used by W2AZ and W2DKJ.

It will be observed that we have suggested two 16-foot lengths of 1 1/8" x 3" redwood. That is a standard-size finished board. The two lengths are run into a rip saw, to produce four lengths each 1 1/8" x 1 1/8" and two lengths which will measure 1 1/8" x 1/2" (approximate measurements, depending on the thickness of the rip saw).

The square lengths are then cut into four lengths of 9 and four lengths of 7 feet, which are to be used for the sections "D" and "E." The remaining flat pieces can be cut after the rest of the assembly is completed. They are used for the transverse braces, "F." The few little pieces which remain are the only waste.

There are so many different ways in which the platform may be mounted and so many different methods for rotation have already been described that there is little point in discussing them here. It is thought that what we have already written, along with the pictures and drawings, is all that is necessary for duplicating this structure.

## How Would You Do It?

(Continued from page 68)

eliminates a slight 'pinging' noticeable with some crystals. Incidentally, the relay must be of a type having low capacity between contacts. It should operate on low current; otherwise the relay circuit itself may be responsible for slight clicks in the immediate vicinity of the transmitter. With a low-current relay, a one-quarter-microfarad



Super-Pro

For HEAVY TRAFFIC

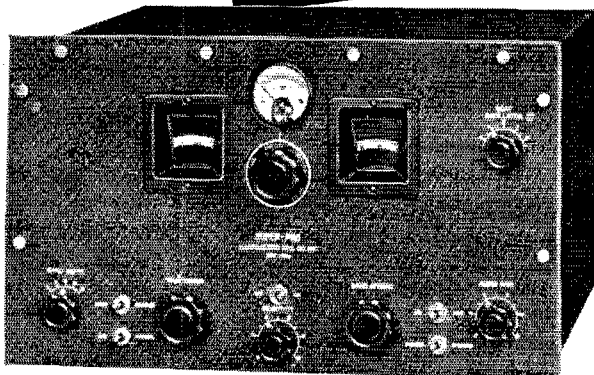

"Super-Pro" bulletin describes, in detail, many of the outstanding features of the "Super-Pro." Included, are details of the special cam switch, dial mechanism, precision crystal unit, and the outstanding tuning unit. Curves are also included.

Handling traffic in crowded amateur bands demands expert operating, and fool-proof equipment. The "Super-Pro" receiver is designed for just such service. Many commercial and government communications systems, both foreign and domestic, employ "Super-Pro" receivers with absolute satisfaction. The wide acceptance of the "Super-Pro" among "professionals" is the result of thorough engineering. Every part of this outstanding receiver is an engineering accomplishment. The exclusive cam-operated knife switch — noiseless and trouble-free, a 12-gang band spread condenser, resulting in constant, uniform band spread, and variable band width control are all features found only in the "Super-Pro." The reason is that this is not an "assembled" job.

Write Dept. Q-10 for bulletin

**HAMMARLUND MANUFACTURING CO., INC., 424-438 West 33rd Street, New York City**  
Canadian Office: 41 West Ave. No., Hamilton, Ont.

## DO YOU WANT TO KNOW — How to Become a Radio Amateur?

The purpose of this booklet is to tell you, as simply and straightforwardly as possible, what amateur radio is, how one can become an amateur, how to build a simple receiver and transmitter, and how to get on the air.

This *NEW EDITION* of HOW TO BECOME A RADIO AMATEUR contains more pages which means much more elaborate treatment of the subject. The receiver is a two-tube one and operates either on A.C. or from a battery supply. This receiver may be built for approximately \$12.00. The transmitter described uses a 6L6 crystal oscillator with the power-supply and antenna-coupling unit on the same board, and will operate on any two bands with one crystal, and with proper crystals may be used on any band from 160 through 20 with an output of approximately 10 watts. This transmitter may be built for approximately \$21.00. Information on the various antennas for the different bands is also given. A code-practice oscillator is also described and may be built for a cost of about \$2.25.

**Price 25c** (NO STAMPS PLEASE)

**AMERICAN RADIO RELAY LEAGUE ■ WEST HARTFORD, CONNECTICUT**

WHEN WE SAY

# 'LIGHTNING'

We're thinking of that funny stuff that comes zooming out of the skies, right through the QRM, lighting up everything in a flash!

AND WHEN WE SAY

# LIGHTNING CALCULATORS

We mean that these gadgets bring an answer right through *mathematical QRM* just like that — in a clear flash!

## Type A, \$1.00    Type B, \$1.00

For problems involving frequency, inductance and capacity, in design of radio frequency circuits. Direct reading answers for size of coils and condensers for any range between 400 kc. and 150 mc.

Gives direct reading answers to calculations involving current, resistance, voltage and power with scale for resistance of copper wire and scale for calculating decibel gain or loss.

## Type C, \$.50    Type D, \$.50

More information on electrical conductors than you could find in a book full of tables.

Gives decibel gain or loss when input and output voltages, currents or power are known.

## Type E, \$.50    Type F, \$.50

Direct reading total resistance of resistors connected in parallel, and total capacity of condensers connected in series.

Permits measurement of resistance, from 1 ohm to 1 megohm by use of a volt-meter. Makes an ohm-meter of your volt-meter.

Prices include postage from the  
**AMERICAN RADIO RELAY LEAGUE**  
West Hartford, Connecticut

condenser across the key contacts (not the relay contacts) removed all trouble from this source. Reports from all stations worked since this oscillator has been installed indicate that the signals are clean and sharp, free from clicks or thumps." —W1IAP.

In Fig. 4 is shown a blocked-grid keying system used by W3GME. This system requires a separate small power supply to provide the blocking biasing voltages.

"The system of break-in keying shown in Fig. 4 has been used successfully at W3GME for over a year with various tubes in all three stages. No keying chirp has ever been reported and complaints from b.c.l.'s have been nil. The taps on the voltage divider are adjusted for normal operation with the key closed; the operating bias for the final amplifier grid is thus provided by its grid leak only. When the key is opened, the bias voltage rises to the no-load value of the bias supply voltage—about 300 volts at W3GME. This voltage is sufficient to block effectively the entire r.f. section. A small resistor and condenser in series across the key eliminate any trace of clicks." —W3GME.

### MISCELLANEOUS HINTS

Wilfred Lowe, New Brunswick, N. J., finds that it helps to eliminate chirps if the oscillator loading is adjusted rather carefully. He uses a small variable coupling capacity between oscillator and the following stage.

Instead of insulating the cathode-circuit coil and condenser of the Tri-tet circuit shown in Fig. 1A, Elbert Benfer, Fort Sheridan, Ill., proposes the use of a 0.01- $\mu$ fd. condenser between cathode and the tuned circuit and an r.f. choke and the key in series between cathode and ground, thus parallel-feeding the cathode and permitting grounding of the cathode circuit coil and condenser.

W3DSI relates an experience in which dirty key contacts were responsible for chirpy keying.

W2ESO reminds us of the importance of a good holder for the crystal.

W8QAN uses EO-1 cable for long keying leads. He states that it has been his experience that twisted lamp cord will not do if chirpless and high-speed keying are desired.

W1KFN uses a 6J5G triode oscillator with a



**NEW HOLDER DESIGN**  
15 SECONDS TO  
INSTALL CRYSTAL

For All Bands  
**GREAT STABILITY**  
Plugs in 5 prong tube socket

Beautiful Appearance

**MODEL AH HOLDER \$1.00** At your dealer or direct

**HIPOWER LOW DRIFT CRYSTALS:**  
within 10 kc. or Choice of stock

AH-10, 1700-3500 Kc. bands \$2.35  
AH-10, 7000-7300 " bands 3.90

WRITE FOR NEW LITERATURE

Hipower "Low Drift" Broadcast and Commercial Crystals Are Approved by F.C.C.

**Hipower Crystal Co., 2035 Charleston St., Chicago**

# Where to buy it

A directory of suppliers who carry in stock the products of these dependable manufacturers.



**BUTLER, MISSOURI** Henry Radio Shop 211-215 N. Main Street

**CHICAGO, ILL.** Allied Radio Corp. 833 W. Jackson Blvd.

**CHICAGO, ILL.** Wholesale Radio Service Company, Inc. 901-911 W. Jackson Blvd.

**COLUMBUS, OHIO** Bell Radio Parts Co. 203 N. Fourth St.

**DETROIT, MICH.** Radio Specialties Co. 171 E. Jefferson Ave.

**DETROIT, MICHIGAN** Radio Specialties Co. 11845 Woodward Ave.

**KANSAS CITY, MO.** Burstein-Applebee Company 1012 McGee Street

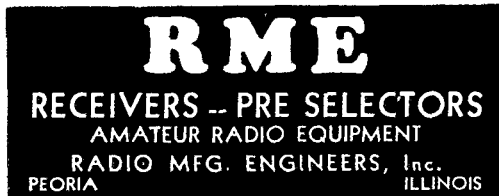

**BUTLER, MISSOURI** Henry Radio Shop 211-215 N. Main Street

**CHICAGO, ILLINOIS** Allied Radio Corp. 833 W. Jackson Blvd.

**CINCINNATI, OHIO** Jos. N. Davies North Bend Road, Mt. Airy

**MINNEAPOLIS, MINNESOTA** Lew Bonn Company 1124-26 Harmon Place

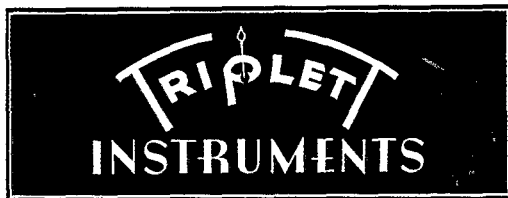

**BUTLER, MISSOURI** Henry Radio Shop 211-215 N. Main Street

**CHICAGO, ILL.** Allied Radio Corporation 833 W. Jackson Blvd.

**CHICAGO, ILL.** Wholesale Radio Service Company, Inc. 901-911 W. Jackson Blvd.

**CHICAGO, ILLINOIS** Electric & Radio Supply Co., Inc. 25 North Franklin Street

**MINNEAPOLIS, MINN.** Lew Bonn Co. 1124-6 Harmon Pl.

● When you do a bang-up job you want the panel instruments to measure right up to the rest of the outfit. At the same time you don't want to spend a fortune.

Right here is where Simpson comes in. It's no longer necessary to pay a premium for panel instruments with the finer bridge type construction and soft iron pole-pieces. The new Simpson Instruments give you these and other quality features at prices no higher than you have paid for the ordinary run of instruments. They are actually the only instruments in the world incorporating these features at low prices.

Write for Catalog No. 10

SIMPSON ELECTRIC CO., 5210 Kinzie St., Chicago



A typical Simpson value is illustrated here—a bridge-type instrument in a beautiful, modern 3"x3 1/4" case with illuminated dial and built-in 6-V lamp at a net price to amateurs in most A.C. and D.C. ranges of only... **\$4.65**

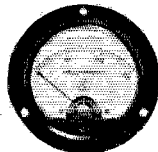

Another big Simpson value is this 3" bridge type Milliammeter at only... **\$4.15**

**SIMPSON** Instruments that *STAY accurate*

## Opportunity

TO PURCHASE AT BARGAIN PRICE

A long-established retail radio store. This sacrifice is made because our full time will be devoted exclusively to manufacturing.

**GROSS RADIO, INC.**

51 Vesey Street

New York City

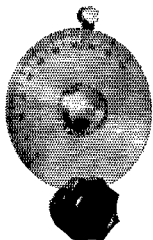

## RADIOCRAFTER

2 3/4" VERNIER DIAL

ROTARY BUFFED NICKEL SILVER DISC. POSITIVE FRICTION DRIVE

No freq. change removing hand from knob, as with plain dials, due to shaft side play. With celluloid pointer, **90c**  
1 1/2" knob, extra, 15c.  
NEW XMITTER DIAL, 60c. NET

At Your Jobber  
or Direct Mail  
Postpaid  
—with His Name  
Send for Catalog

NEW ENGLAND  
**RADIOCRAFTERS**  
1156 COMMONWEALTH AVE.  
BROOKLINE, MASS.

## Better PANEL INSTRUMENTS AT PRICES YOU CAN AFFORD!

50,000-ohm grid leak and a 300-ohm cathode resistor. His key is placed between the cathode resistor and ground. He has discovered that keying characteristics are improved if the usual cathode-resistance by-pass condenser is omitted and a 1- $\mu$ f. condenser is placed across the key terminals at the transmitter.

### PRIZES

First prize—S. E. Spittle, W9QOA.

Second prize—Albert LaRue, W1IAP, W8NMM.

In addition to those mentioned previously, we wish to express sincere thanks to W3BGD, W5DXA, PA0EE and a contributor from Ogden, Utah, who forgot to sign his name.

Rules under which this contest is conducted are as follows:

1. Solutions must be mailed to reach West Hartford before the 20th of the publication month of the issue in which the problem has appeared. (For instance, solutions of problem given in the May issue must arrive at *QST* before May 20th.) They must be addressed to Problem Contest Editor, *QST*, West Hartford, Conn.

2. Manuscripts must be not longer than 1000 words, written in ink or typewritten, with double spacing, on one side of the sheet. Diagrams and sketches may be in pencil, but must be neat and legible.

3. All solutions submitted become the property of *QST*, available for publication in the magazine.

4. The editors of *QST* will serve as judges. Their decision will be final.

Prizes of \$5 worth of A.R.R.L. station supplies or publications will be given to the author of the solution considered best each month, \$2.50 worth of supplies to the author of the solution adjudged second best. The winners should provide us with a list of the supplies preferred.

### A.A.R.S. Activities

(Continued from page 51)

The following cryptogram is designed for interested cipher busters and solutions will be acknowledged if sent to the Liaison Officer, A.A.R.S., 3441 Munitions Bldg., Washington, D. C.:

HTNQT AASYH NBSIY KYEKK YTCOJ  
OJZIA PEXNN FIWAZ MZNQT AAMWX  
JAHWA OWOQA LRQSH TEJYR DAYJZ  
ANPOH TNQAL RQSHT EVAPE NXNFI  
WAPWL NFXID NHKON GFRWJ DNLPR  
ZWIJF WAPLW PNGWN YZTWR BWADN  
HTNDP AYOIH KOXSZ HAEQW ZTWTS  
PLHTN UAJNA WLRBA HNPZC YLWXJ  
OPWPZ JSPSN XYLWN RZGJN MVIYV  
XJOPW PZJSP

### SPECIAL TO AMATEURS

Piezo-Electric Crystals — \$2.50 EACH POSTPAID

Until supply is exhausted... we offer 80 meter band crystals unmounted; accurate calibration, excellent oscillators. Limited quantity.

### SCIENTIFIC RADIO SERVICE

"The Crystal Specialists Since 1925." University Park, Hyattsville, Md.

# HAM-ADS

(1) Advertising shall pertain to radio and shall be of nature of interest to radio amateurs or experimenters in their pursuit of the art.

(2) No display of any character will be accepted, nor can any special typographical arrangement, such as all or part capital letters be used which would tend to make one advertisement stand out from the others.

(3) The Ham-Ad rate is 15c per word, except as noted in paragraph (6) below.

(4) Remittance in full must accompany copy. No cash or contract discount or agency commission will be allowed.

(5) Closing date for Ham-Ads is the 25th of the second month preceding publication date.

(6) A special rate of 7c per word will apply to advertising which, in our judgment, is obviously non-commercial in nature and is placed and signed by a member of the American Radio Relay League. Thus, advertising of bona fide surplus equipment owned, used and for sale by an individual or apparatus offered for exchange or advertising inquiring for special equipment, if by a member of the American Radio Relay League takes the 7c rate. An attempt to deal in apparatus in quantity for profit, even if by an individual, is commercial and all advertising by him takes the 15c rate. Provisions of paragraphs (1), (2), (4) and (5) apply to all advertising in this column regardless of which rate may apply.

Having made no investigation of the advertisers in the classified columns, the publishers of *QST* are unable to vouch for their integrity or for the grade or character of the products advertised.

**QUARTZ**—direct importers from Brazil of best quality pure quartz suitable for making piezo-electric crystals. Diamond Drill Carbon Co., 719 World Bldg., New York City.

**RADIO** engineering, broadcasting, aviation and police radio, servicing, marine and Morse telegraphy taught thoroughly. All expenses low. Catalog free. Dodge's Institute, Byrd St., Valparaiso, Ind.

**QSL'S**, W28N, Helmetta, N. J.

**USED** receivers. Bargains. Cash only. No trades. Price list 3¢. W3DQ Wilmington, Del.

**QSL'S**, all colors, cartoons, snappy service. Write for free samples today. WIBEF, 16 Stockbridge Ave., Lowell, Mass.

**CALLBOOKS**—Fall edition now on sale containing complete up-to-date list of radio hams throughout entire world. Also world prefix map, press schedules and new time conversion chart. Single copies \$1.25. Canada and foreign \$1.35. Radio Amateur Call Book, 610 S. Dearborn, Chicago.

**QSL'S**, Cuts. Cartoons. Free samples. Theodore Porcher, 7708 Nahavoo, Philadelphia, Penn.

**1000 watt G.E. transformers** 1100-2200-4400 volts each side c.t. Guaranteed. \$13.50. Dawson, 5740 Woodward, Detroit, Mich.

**QSL'S**. Free samples. Printer, Corwith, Iowa.

**FREE** air mail service. Guaranteed crystals 160-80M AT and 40M X, \$1.95; 40M AT, \$2.75; loss mounting, \$1. State frequency desired. Commercial crystals quoted. C.O.D.'s accepted. C-W Mfg. Co., 1170 Esperanza St., Los Angeles.

**QSL'S**, SWL's: one color 45¢, two color 60¢ hundred, postpaid. Samples. W1FTM, 268 Piedmont, Waterbury, Conn.

**CRYSTALS**: Eidson's 'T9 X-cut 40-80 meters, \$1.60. 7301-7500 k.c.'s, \$2. Holders, \$1.10. Fully guaranteed. C.O.D.'s O.K. Buy these from Van Radio, 464 E. 117th, No. 7, Cleveland, Ohio.

**QSL'S**. Better designs—better stock—better workmanship. Free samples to hams. W2FJE, 101 Hanson Place, Brooklyn, N. Y.

**FREE** catalog. Y-cut crystals, 75¢. Other cuts reasonable. Also commercial crystals. Faberadio, Batavia, Ill.

**QSL'S**, SWL's. 100-3 color—75¢. Lapco, 344 W. 39th, Indianapolis, Ind.

**CRYSTALS**, mounted, 80-160 \$1.25, V-cut 40 \$2.25. R9 Crystals, 338 Murray Ave., Arnold, Pa.

**AMATEUR** radio licenses, home study course in code and theory—reasonable, efficient, and thorough. Results guaranteed. American Radio Institute, 200 Broadway, N. Y.

**CRYSTALS**: 80 meter X cuts, \$1.50. Ground to spot frequency, \$2. Mounted beautiful new molded XM6260 holder, 90¢ additional. Ham Crystals, 1104 Lincoln Place, Brooklyn, New York.

**BASSETT** buys for cash Collins, Harvey, Temco transmitters; National, Hammarlund, RME receivers; etc. Send data and desired price to W9ZDO.

**RADIO** amateur course, 50¢ postpaid, W9KJF, Indianapolis. **AMATEUR** Tube Engineering Handbook and Transmitter Circuits Hammanual and log book all for 50¢ postpaid. W9KJF, Indianapolis.

**NATIONAL**, Bliley, Hammarlund, Hallicrafter, RME, RCA, Taylor, Thordarson, etc. Van Sickle, W9KJF, Indianapolis.

**MODERN** 400-500 watt phone—c.w. all-band transmitter. Rack and panel. Sell at reasonable price. W9WYL.

**WON** Candler code system at hamfest. Make offer. W9WYL.

**SACRIFICE**: 300 watt diathermy machine—4 tubes—white cabinet. W2IYF.

**TRADE**: new 852 never in socket, also valuable Kennedy Type 110 Universal all-wave receiver, thirteen by twenty inches, and two stage amplifier.—For any standard make oscilloscope with two amplifiers and sweep circuit and tube not less than three inches diameter. Must be perfect condition. W6HLI.

**SELL**: 1/2 H. P. Briggs & Stratton gasoline motor, used 50 hours. Ideal power for portable generator. W8RTE, Rockford, Mich.

**WANTED**: high quality recording head and associated equipment. W9RKW.

**NC101X** complete—A-1 condition—best offer. A. Nuzer, 603 Malone Pl., Harrison, N. J.

**ATTRACTIVE** imitation gold lettered call signs for your station. Write to Slack's Specialty Shoppe, 106 Arnold Ave., W. Babylon, N. Y.

**QSL'S**, QSL's. Made-to-order. World's finest. Samples? (stamp) W8DED, Holland, Mich.

**BLILEY** crystals, patronize W8DED.

**PATTERSON** PR16C—\$50, cash or trade for good reflex camera. W. P. Cecil, Norco, La.

**HALLICRAFTERS** SX-16 with matching speaker, and Trimm featherweight phones, \$90, cash. Lester E. Crossman, 52nd Ordnance Co., Savannah, Ill.

**WANTED**: complete outfit, rig and receiver. What have you? How much? Cash, or trade nearly new Winchester Model 12 pump gun and cash. W9MRJ.

**WANTED**: Hallicrafter SX-16 complete with xtal and speaker. Give lowest cash price. N. E. Vance, Jr., 955 S. 5th St., Salina, Kansas.

**FOR** sale: 101 consecutive *QST*'s to date; 31 Radio same as above—all fine shape. Make an offer. W8FEU, 35 W. Main St., Amsterdam, N. Y.

**SELL** modern 400 watt phone—c.w. transmitter complete. Two units, enclosed. Air demonstration. \$385. W2AEB.

**TELEPLEXES**, instructographs, omnigraphs bought, sold. Ryan's, Hannibal, Mo.

**QSL'S**. Best there is. Free samples. Maleco, 1805 St. Johns Place, Brooklyn, N. Y.

**COMPLETE** station, W1LDD: 300 watt c.w.; bread-board transmitter; 6A6 oscillator; 47 doubler; 6L6G buffer; pair 6X4 p.p. in final amplifier; 6 Weston meters; 500 and 1000 volt power supplies; FB7X with preselector and power supply; coils for 20, 40, and 80; Baldwin earphones—\$125, complete or will sell separately. Arthur L. Ballou Estate, Uxbridge, Mass.

**SWAP**: \$75. guitar—want FB7 or similar receiver. W2HXY, 200 Cleveland Ave., Harrison, N. J.

**QSL'S**, custom built. Samples. W8BZK, Newark, Ohio.

**FEATURING** popular brands transmitting tubes—write Loughnane & Co., Decatur, Ill.

**CONTROL** your angle of radiation—tilting head rotary. Telescoping aluminum tubing, complete worm drive assembly using variable speed motor, magnetic direction indicator. Continuous rotation. Save half on your beam. W8MLL.

**GENERAL** Electric 24/750 volt 200 mill dynamometers with filter, \$20. Westinghouse 500 watt 6-15 volt, \$8. 500 watt 500 cycle, \$8. 900 cycle 200 watts, \$15. Henry Kienzie, 215 Hart Blvd., Staten Island, N. Y.

**LISTEN** for W9XA, high frequency broadcast station, 26,450 k.c.'s, Kansas City.

**UNASSEMBLED** transmitter, *QST* Jan., 1935, tubes AT-cut crystal, power supply complete, 4-tube U.R.F. receiver, monitor. Complete, \$50. 80 consecutive *QST*'s to date, perfect condition, \$8. Collector's note: first year's issue of Radio—state cash offer. W2EBF.

**CRYSTALS**: X-cut, 1750-2000, 3500-4000, five kilocycles, \$1.50; spot frequency, \$2.50. Three small, 80 meter blanks, including carborundum, \$1.20. William Threm, W8FN, 3071 Moosewood St., Cincinnati, Ohio.

**MODEL** 189 Supreme multi-wave signal generator oscillator—Just like new, \$22., with instructions. Robison's Manual Radio Telegraphy and Telephony, \$2.50; Hawkin's Electrical Guide, ten volumes, \$6. W. Wakeman, Hancock, N. Y.

**FOR** sale: 112 watt 75 fone transmitter. W9INY.

**SELL**: transmitter complete, fifty watter, \$40. W9BSJ.

**FRITZ'S** QSL's—SWL's lead the field in workmanship. Samples. 465 Mason, Joliet, Ill.

**SACRIFICE** Comet xtal Pro complete: Janette 110 d.c. to 110 a.c. converter 175 watts filter. Weir, Arta, 10 Bridge, N. Y. C.

SELL dismantled station. 300 watt fone, c.w. transmitter. Quality parts. FBXA, preselector, power supply, speaker, phones, 3 sets coils. Miscellaneous station parts, tools, fittings. \$250. or best offer. W9NCA.

WANTED: high impedance bone conduction hearing unit, transformer. Price and describe. W3EYY.

RECEIVER headquarters. W8ANT.

USED a.c. SW3. Ten sets coils. W8ANT.

USED d.c. SW3. Two sets coils. W8ANT.

USED oscilloscope. W8ANT.

USED FBXA—coils—power pack. W8ANT.

USED genemotors. W8ANT.

USED ACR-136, perfect. W8ANT.

NEW receivers—all makes. W8ANT.

TRANSMITTER headquarters. W8ANT.

CHASSIS drilled to order. W8ANT.

BUY—sell—exchange. Write W8ANT.

CHASSIS—cabinets—racks. W8ANT.

USED transmitting tubes. W8ANT.

COMMUNICATION headquarters. Transmitters designed and built to order. Receivers serviced. All phases of high frequency communication. Write to Southern Ohio's only amateur owned amateur business. Jos. N. Davies, W8ANT, 2767 N. Bend Rd., Sta. A., Cincinnati, Ohio.

QSL'S, finest quality, lowest prices, 500—\$2. postpaid. Free samples to hams. Howe Brothers, Wisner, Neb.

ROTARY beams complete for 10 and 20 meters. Tubing only for 20—\$15. Write International Arrays, 1577 Olivewood Ave., Lakewood, Ohio.

SELLING out, stamp for list used parts. W8KDU, 5 E. Burgess, Mt. Vernon, Ohio.

METER repair: d.c. milliammeters, springs repaired, \$1.75. Thermocouples 1 to 5 amperes, \$2.50. Factory parts used, repairs absolutely guaranteed. Prices quoted on all matters. Braden Engineering Co., 1809 Fifth Ave., Dept. B, Dayton, Ohio.

MUST sell; first \$100, takes 100 watt fone. Come get it. W3GK.

YOUR own call letters on automobile license plates for automobile, house, or station. 1 1/4" letters embossed, baked enamel. \$2. pair postpaid. Norwood Products, 75 East Wacker, Chicago.

WHEN buying amateur equipment whether you pay cash, trade equipment, or buy on terms, it's to your advantage to write me. Write me for the latest equipment. W9ARA, Butler, Mo.

BRAND new in factory sealed cartons: Ultra-Skryiders, \$59.; PR-15s, \$99.; SX15 Sky-Challengers, \$59.; ACR-175s, \$89.; ACR-155s, \$44.50; standard Mac-Bugs, \$5.95. W9ARA.

RECONDITIONED guaranteed sets shipped on ten day trial: HROs, \$129.70; RME-69s, \$99.; NC100s, \$79.; PR-15s, \$79.; SX-16s, \$79.; Breting 12s, \$69.; Ultra-Skryiders, \$54.; Sky-Challengers, \$49.; SX9 Super-Skryiders, \$39.; Comet Pros, \$39.; Silver 5Cs, \$29.; PR-10s, \$29.; FB7s, \$19.; Super-Skryiders, \$19.; Sky Buddies, \$17.50; latest SW3s, \$12.50. Many other sets. List free. W9ARA.

CODE machines rented. W9ARA.

CRYSTALS: you're not paying for high priced advertising when you buy Eidson T9 crystals, this means a saving to you. T9 crystals speak for themselves—and how, as thousands of well pleased users will testify. High activity type, fracture resisting X-cut, fully guaranteed. Each with individual calibration sheet: 40 and 80 meters, \$1.60. T9 ceramic holders, \$1.10. Priced postpaid. C.O.D.'s accepted. Sold by these and other dealers: Van Radio, 464 E. 117th, No. 7, Cleveland, Ohio; Henry Radio Shop, Butler, Mo.; or Eidson's, Temple, Texas.

WILL trade accounting course or radio servicing course for appropriate 2500 volt transformer or oscilloscope. W8NKC.

DOUGLAS modulation transformers. Designed by W8UD. Match all tubes. 50 watts audio, \$4.95 pair; 100 watts audio, \$7.75 pair. One year guarantee. Postpaid in U. S. Write for details. Sold exclusively by W9IXR, Rice Lake, Wis.

SACRIFICE surplus. Esco 900 v. MG, Acme Delta xfmrs, HFC rx, SW3 coils, oscilloscope, GR Wavemeters, freq. meter, Weston meters, Billey xtals, mostly for 50% of cost or less. Send for list. W1WV.

ANTENNA wire, magnet wire, EO-1 cable, multi-conductor control cables, concentric lines. W8DT.

## RADIO ENGINEERING



RCA Institutes offer an intensive course of high standard embracing all phases of Radio and Television. Practical training with modern equipment at New York and Chicago schools. Also specialized courses and Home Study Courses under "No obligation" plan.

Illustrated Catalog on request

**RCA INSTITUTES, INC.** Dept. ST-38

A Radio Corporation of America Service

75 Varick St., New York 1154 Merchandise Mart, Chicago

# GO ON THE AIR *with the* NEW SHURE ROCKET

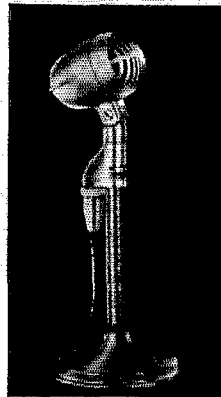

Enjoy the performance and beauty of this new deluxe communications-type crystal microphone. The ROCKET brings you ultra-modern streamlined design and the world-famous Shure "high-efficiency" speech characteristic. Doubles power on important intelligibility speech frequencies — gives clear, crisp speech that cuts through noise and static. Tilting head finished in rich Satin Chrome. Equipped with new built-in Cable Connector. Desk Mount in Iridescent Gray.

Ask Your Jobber or Write for  
New Catalog 150Q

Model 706S, "ROCKET" (as illustrated), complete with Desk Stand and 7 ft. cable with plug attached. List price.....\$27.50

Model 706SH. Same, without desk stand. List Price.....\$25

Model 705W, "Super-Level" Communications Crystal Microphone, complete with desk stand and 7 ft. cable with plug attached. List Price.....\$25

Shure patents pending. Licensed under patents of the  
Brush Development Company



## LEARN CODE RIGHT

INSTRUCTOGRAPH tapes send you typical messages, Radio or Morse, any speed. Easy, practical way to improve. Senior Model with 10 tapes and Book of Instructions \$20.25. Rent at \$3.00 first month, \$2.25 additional month. 25¢ per month more with transformer and tube socket (oscillator unit). With key and head phones another 25¢ per month. \$10.00 deposit or satisfactory references required.

Junior Model, with 5 tapes and Book of Instructions \$12.00 (not rented). Complete oscillator equipment less battery \$6.50. Write for details today.

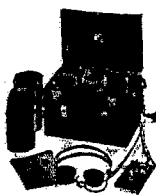

## INSTRUCTOGRAPH COMPANY

Dept. Q-10, 912 Lakeside Place, Chicago, Illinois

Representatives for Canada:

Radio College of Canada, 863 Bay Street, Toronto

## LEARN RADIO

— TELEVISION —

500 Licensed graduates placed in past 7 years in shipping, broadcasting, aviation, police, etc.; we also teach radio servicing and repairing, new term Sept. 12th, Nov. 7th day or eve.; 52-page catalog free, oldest, largest and best equipped.

## MASS. RADIO SCHOOL

18 Boylston Street, Boston

G. R. Eatwistle, Pres.  
Established 1899

R. F. Trop, Treas.  
Hancock 8184

# Your Nearest Dealer Is Your Best Friend

Your nearest dealer is entitled to your patronage. You can trust him. He is equipped with a knowledge and understanding of amateur radio. He is your logical and safe source of advice and counsel on what equipment you should buy. His stock is complete. He can supply your needs without delay. His prices are fair and consistent with the high quality of the goods he carries. He is responsible to you and interested in you.

Patronize the dealer nearest you — You can have confidence in him

## CHICAGO, ILLINOIS

Allied Radio Corporation  
833 West Jackson Blvd.

Complete standard lines always in stock—W9IBC, W9DDM, W9GEZ

## CHICAGO, ILLINOIS

Chicago Radio Apparatus Company  
415 South Dearborn Street (Est. 1921)

W9RA and W9PST — Amateurs since 1909

## CHICAGO, ILLINOIS

Wholesale Radio Service Company, Inc.  
901-11 West Jackson Boulevard

"The World's Largest Radio Supply House"

## DES MOINES, IOWA

Iowa Radio Corp.  
1212 Grand Avenue  
Complete amateur stock, W9OCG—W9EMS—W9KAY

## DETROIT, MICHIGAN

Radio Specialties Company  
171 E. Jefferson Avenue  
Ham Supplies — National & Hammarlund Sets and Parts

## KANSAS CITY, MISSOURI

Burstein-Applebee Company  
1012-14 McGee Street  
"Specialists" in supplies for the Amateur and Serviceman

## KANSAS CITY, MISSOURI

Radiolab  
1515 Grand Avenue  
Amateur Headquarters in Kansas City

## MILWAUKEE, WISCONSIN

Radio Parts Company, Inc.  
538 West State Street  
Complete stock Nationally Known products

## MINNEAPOLIS, MINNESOTA

Lew Bonn Co.  
1124-26 Harmon Place  
W9BP—W9TLE—W9HOP—W9DKL—W9LEX

## OAKLAND, CALIFORNIA

Offenbach Electric Company  
2085 Broadway  
"The House of a Million Radio Parts"

## SAN FRANCISCO, CALIFORNIA

Offenbach Electric Company, Ltd.  
1452 Market Street  
"The House of a Million Radio Parts"

## SEATTLE, WASHINGTON

Northern Radio Company  
2208 Fourth Avenue  
W7AWP and W7CR to serve you

## ST. LOUIS, MISSOURI

Van Sickle Radio Company  
1113 Pine Street  
W90WD invites you to amateur headquarters in St. Louis

## TORONTO, CANADA

A & A Radio Service Supply  
101 Queen Street, West  
Canada's foremost radio supply house

## TORONTO, ONTARIO, CANADA

Wholesale Radio Company, Ltd.  
1133-37 Bay Street  
Canada's Largest Radio Parts Distributors — VE-3XB

## WINNIPEG, CANADA

Electrical Supplies, Ltd.  
306-10 Ross Avenue  
Western Canadian Amateur Headquarters for leading lines

# You Are Protected When You Buy From QST Advertisers

“Advertising for QST is accepted only from firms who, in the publisher’s opinion, are of established integrity and whose products secure the approval of the technical staff of the American Radio Relay League.”

Quoted from QST’s advertising rate card.

Every conceivable need of a radio amateur can be supplied by the advertisers in QST. And you will know the product has the approval of the League’s technical staff.

## Index to Advertisers

|                                         |                    |
|-----------------------------------------|--------------------|
| Ace Products Company                    | 117                |
| Astatic Microphone Laboratory, Inc.     | 98                 |
| Barker & Williamson                     | 98                 |
| Birnbach Radio Company, Inc.            | 114                |
| Bliley Electric Company                 | 85, 110            |
| Browning Laboratories, Inc.             | 102                |
| Burgess Battery Company                 | 95                 |
| Candler System Company                  | 38                 |
| Capitol Radio Engineering Institute     | 100                |
| Cardwell Manufacturing Corp., Allen D.  | 78                 |
| Centralab                               | 79                 |
| Collins Radio Company                   | Cov. 2             |
| Connecticut Telephone & Electric Corp.  | 84                 |
| Cornell-Dubilier Electric Corp.         | 100                |
| Dodge’s Institute                       | 114                |
| Eitel-McCullough, Inc.                  | 81                 |
| Feighner Technical Associates           | 110                |
| Cardiner Levering Company               | 111                |
| Gross Radio, Inc.                       | 86, 122            |
| Hallicrafters, Inc., The                | 1, 2               |
| Hammarlund Manufacturing Company, Inc.  | 83, 119            |
| Harvey Radio Company                    | 116                |
| Harvey Radio Laboratories               | 111                |
| Heintz & Kaufman, Ltd.                  | 117                |
| Henry Radio Shop                        | 102                |
| Hipower Crystal Company                 | 120                |
| Hytronic Laboratories                   | 87                 |
| Instructograph Company                  | 124                |
| International Resistance Company        | 89                 |
| Johnson Company, E. F.                  | 93                 |
| Ken-Rad Tube & Lamp Corp.               | 117                |
| Kenyon Transformer Company, Inc.        | 7                  |
| Lefebure Corporation                    | 106                |
| Mallory & Company, Inc., P. R.          | 76                 |
| Massachusetts Radio School              | 124                |
| McGraw-Hill Book Company                | 92                 |
| Meissner Manufacturing Company          | 91                 |
| Mims Radio Company                      | 115                |
| National Company, Inc.                  | Insert, 75, Cov. 3 |
| New England Radiocrafters               | 122                |
| New York Y. M. C. A. Schools            | 115                |
| Newark Electric Company                 | 97                 |
| Newton Institute of Applied Science     | 118                |
| Ohmite Manufacturing Company            | 82                 |
| Port Arthur College                     | 111                |
| Precision Apparatus Corp.               | 80                 |
| Precision Piezo Service                 | 115                |
| Premax Products                         | 106                |
| RCA Institutes, Inc.                    | 124                |
| RCA Manufacturing Company, Inc.         | 114, Cov. 4        |
| Radio Mfg. Engineers, Inc.              | 127                |
| Radio Shack, The                        | 113                |
| Radio Supply Company                    | 112                |
| Radio Transceiver Laboratories          | 90                 |
| Raytheon Production Corp.               | 77                 |
| Scientific Radio Service                | 122                |
| Shure Brothers                          | 124                |
| Sickles Company, F. W.                  | 111                |
| Simpson Electric Company                | 122                |
| Solar Manufacturing Corp.               | 110                |
| Sun Radio Company                       | 120                |
| Taylor Tubes, Inc.                      | 4, 5               |
| Teleplex Company                        | 118                |
| Television Sales & Service Corp.        | 94                 |
| Terminal Radio Corp.                    | 112                |
| Thordarson Elec. Mfg. Company           | 99                 |
| Triplett Elec. Instrument Company, Inc. | 118                |
| United Transformer Corp.                | 128                |
| Utah Radio Products Company             | 103                |
| Valpey Crystals, The                    | 117                |
| Van Nostrand Company, D.                | 107                |
| Wincharger Corp.                        | 115                |
| Vaxley                                  | 76                 |



introducing . . .

# RME's NEW 70 Series

(Companion to the RME-69 Models)

## WITH THESE STANDARD FEATURES:

1. New and Larger Illuminated Indicating Meter
2. New Iron Core I F Transformer
3. Automatic Noise Suppressor
4. Break-in Relay Control Circuit
5. Improved Audio Characteristics
6. One-stage Radio Frequency Amplification
7. Total Complement, 10 Tubes
8. Streamlined Design
9. Crystal Filter Circuit Standard
10. The same sturdy construction, same fidelity to detail in engineering, same high quality workmanship, that have always been characteristic of RME products.

LOWER IN COST

*Circular gladly sent on request*

## RADIO MFG. ENGINEERS

111 Harrison Street, Peoria, Illinois

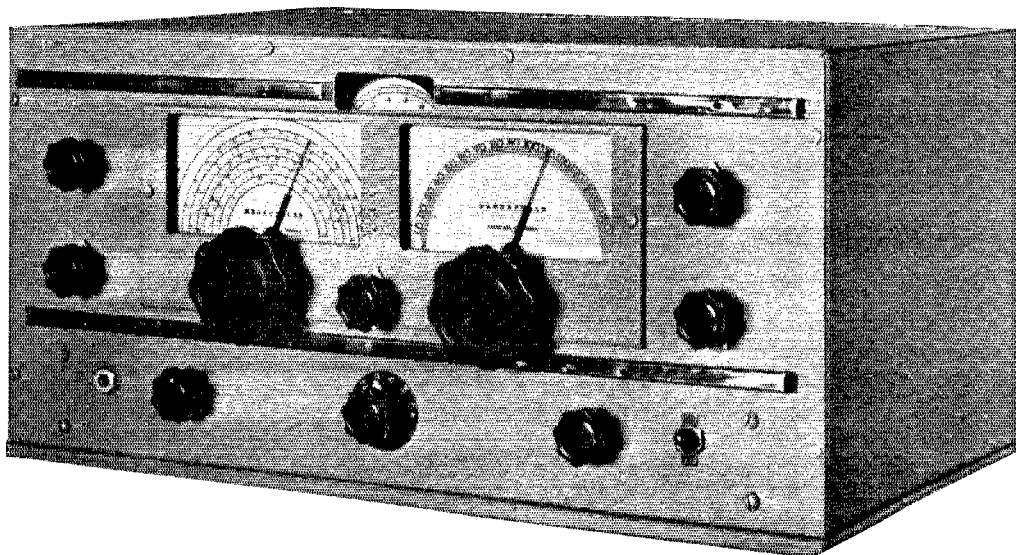

# New BEAM POWER-COMPRESSOR AMPLIFIER KITS

The new improved UTC PA amplifier and modulator kits incorporate every advanced circuit feature desirable for PA and amateur work.

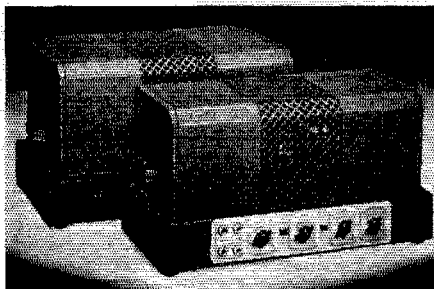

The kits are provided complete with panels, covers, resistors, condensers, sockets, jacks, etc. All components are completely mounted and ready to wire, complete constructional details and diagrams are furnished.

**VOLUME LIMITING** Volume limiting in amplifier equipment is ideal for the home and PA application inasmuch as the equipment can be operated at high levels without any fear of blasting on peaks of power. In PA service the changes in level encountered when a speaker moves toward the microphone is minimized by the amplifier compression. In modulator work the limiting action minimizes the tendency for over-modulation due to sudden increase of input signals, thus permitting a higher gain control setting *doubling the effective transmitter power.*

**COMPONENTS** The new UTC PA amplifier kits are unusually trim in appearance, employing blackchrome etched panels contrasting with the gray commercial wrinkle finish of the chassis and perforated metal cover.

All kits are furnished with four input jacks providing for dual input (high or low gain) to both channels of the mixer. The mixing system is completely cross-talk proof. The unique UTC VARITONE equalizer is incorporated to equalize high frequencies or low frequencies, as desired. VARIMATCH output transformers are employed in kits for PA, modulator and driver service.

The output impedances on PA kits are 500, 200, 15, 8, 5, 3, and 1½ ohms.

## TECHNICAL CHARACTERISTICS

### P-1A

PA kit, self bias, 30 watts output, audio and power units on separate chassis for rack or cabinet mounting. Four jack, dual channel, high impedance input, two high gain (120DB), two low gain (80DB). VARITONE equalizer and compression controls. Output impedances for line and voice coil as above.

List price.....\$87.50  
Your net cost.....\$52.50

### P-1M

Modulator amplifier kit, same as above, but for modulation purposes. VARIMATCH output has the following impedances: 200, 405, 1180, 2350, 2400, 3000, 4000, 4670, 4750, 5660, 7000, 9100, 9500.

List price.....\$87.50  
Your net cost.....\$52.50

Tubes required for P-1A or P-1M kits are: two 6J7, one 6N7, two 6C5, two 6L6, one 83, one 6H6.

### P-2A

PA kit, fixed bias, 50 watts output, audio and power units on separate chassis for rack and cabinet mounting. Four jack, dual channel, high impedance input, two high gain (120DB), two low gain (80DB). VARITONE equalizer and compression controls. Has output for line or voice coils, as specified.

List price.....\$97.50  
Your net cost.....\$58.50

### P-2M

Modulator kit, same as above, but has VARIMATCH output having impedances of 360, 660, 2050, 3740, 4100, 7000, 7500, 8200, 12000, 12600, 15000, 16400, 21500, 29800 on the 3300 ohm plate to plate terminals. Also has 237, 1300, 1750, 2700,

3270, 5200 ohms on the 4000 ohm plate to plate input terminals.

List price.....\$97.50  
Your net cost.....\$58.50

Tubes required for the P-2A or P-2M kits: two 6J7, one 6N7, two 6C5, two 6L6, one 83, one 80, one 6H6.

### P-3A

PA kit, fixed bias, 100 watts output. Audio and power on separate chassis for rack or cabinet mounting. Four jack, dual channel, high impedance input, two high gain (120DB), two low gain (80DB). VARITONE equalizer and compression controls. Line and voice coil output.

List price.....\$142.50  
Your net cost.....\$85.50

### P-3M

Same as P-3A, but has VARIMATCH output with impedances of 270, 300, 1440, 2760, 2900, 3700, 4900, 5650, 5800, 6900, 8400, 11000, 12000.

List price.....\$142.50  
Your net cost.....\$85.50

Tubes required for the P-3A and P-3M kit: two 6J7, one 6N7, two 6C5, four 6L6, two 6F6, three 83, one 80, one 6H6.

### P-4D

10 watt compressor driver amplifier, self bias. 10 watts output, sufficient to drive any class A B, or class B amplifier of 100 watt to 250 watt rating. The ideal driver, incorporating: compressor, low reflected drive impedance, multi-channel input, high gain, and VARITONE equalizer. One chassis. Four jack, dual channel, high impedance input, two high gain (117DB), two low gain (77DB). VARITONE equalizer and compression controls. VARIMATCH driver transformer incorporated as output unit.

List price.....\$65.00  
Your net cost.....\$39.00

### P-4A

Ideal 10 watt home amplifier. Same as above, but with PA VARIMATCH output transformer to 500, 15, 8, 3, 1½ ohms.

List price.....\$65.00  
Your net cost.....\$39.00

Tubes required for the P-4D and P-4A kit: two 6J7, one 6N7, one 6C5, two 2A3, one 5Z3, one 6H6.

### P-5A

PA kit, self bias, 15 watts output. One chassis. Four jack, dual channel, high impedance input, two high gain (120DB), two low gain (80DB). VARITONE equalizer and compression controls. Output impedance for line and voice coils, as specified.

List price.....\$62.50  
Your net cost.....\$37.50

### P-5M

Modulator kit, same as P-5A, but with VARIMATCH output having impedances of 270, 500, 1440, 2760, 2900, 3700, 4900, 5650, 5800, 6900, 8400, 11000, 12000.

List price.....\$62.50  
Your net cost.....\$37.50

Tubes required for P-5A or P-5M kit: two 6J7, one 6N7, one 6C5, two 6V6, one 83, one 6H6.

### P-7A

AC operated pre-amplifier kit designed especially for amateurs and PA service. Very efficient filtering assuring freedom from hum. Has a gain of 70DB, and a two channel high impedance, high level mixer with jack input for each channel. Output impedances are 50, 200, and 500 ohms.

List price.....\$30.00  
Your net cost.....\$18.00

Tubes required for the P-7A: two 6J7, one 6N7, one 6X5.

## UNITED TRANSFORMER CORP.

72 SPRING STREET

NEW YORK, N. Y.

EXPORT DIVISION 100 VARICK STREET NEW YORK, N. Y. CABLES 'ARLAB'

# for Transmitting

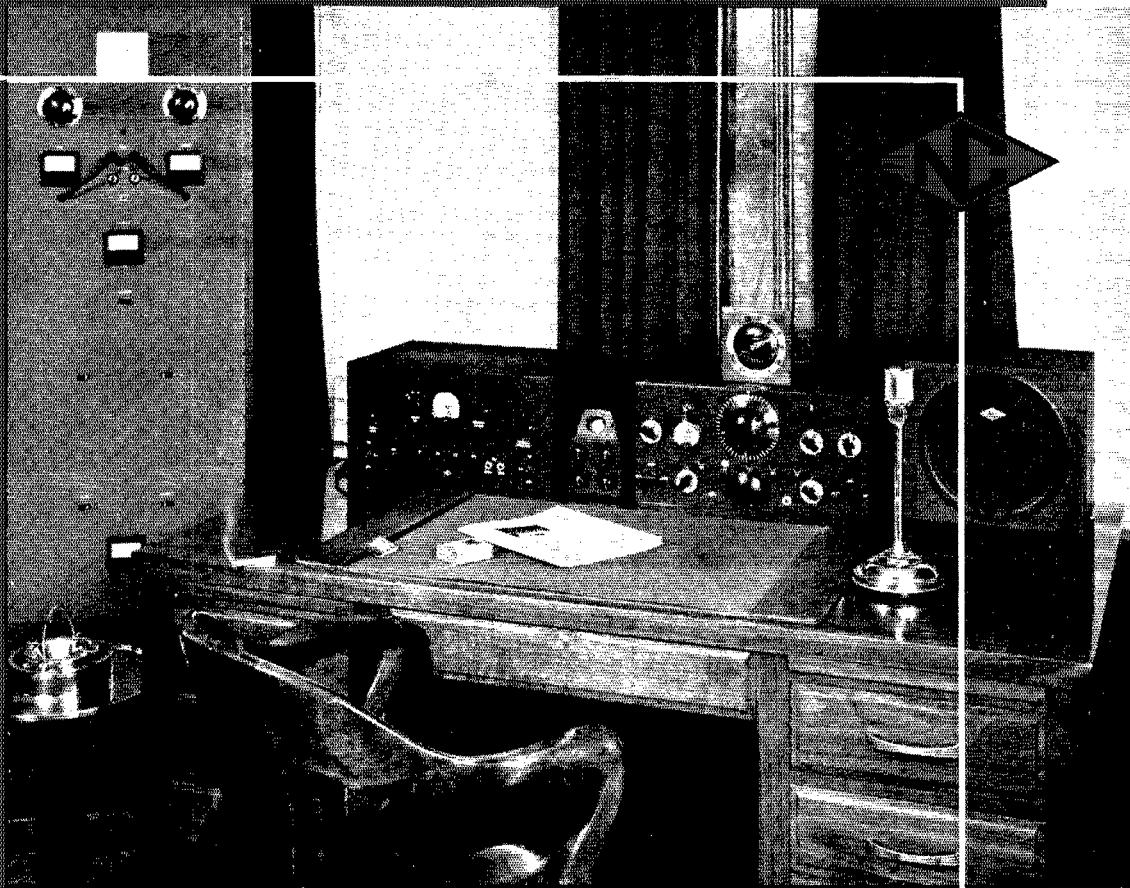

National Transmitting Equipment is ideally suited to the requirements of the amateur. It is moderate in cost, high in performance, and handsome in appearance. So more than this, it also has the versatility that makes ownership a long term investment. The Foundation Units make it easy to build to specialized requirements, and to rebuild to meet changing needs. The NTE Universal Exciter and Speech Amplifier, in one self-contained unit, solves all the most difficult engineering problems to be met in building a transmitter. With National Equipment, the pleasure in constructing a fine transmitter is equaled only by its economy.

AMATEURS SAY...

# These RCA Television Tubes are FB for Communications Use, Too!

**T**HE RCA 1852 and 1853 were designed primarily for use in the picture channel amplifier circuit of experimental television receivers. But because of their high mutual conductance many amateurs have found these tubes excellent for use as r-f or i-f amplifiers in communications receivers. The high value of mutual conductance results in surprisingly high gain, provides superb signal-to-noise ratio.

At 60 megacycles, the 1852 gives you about three times as much gain as do conventional r-f amplifier tubes. The 1853 has remote cut-off characteristics which permit the handling of a larger range of signals.

Both tubes make fine oscillators for low-voltage applications and both have grid connections at tube base. This construction eliminates grid cap and is important at high frequencies because it provides decreased feed-back and improves circuit stability. Price, only \$1.85 apiece. Further details are available on request.

These types are available at your nearest RCA Distributor

*RCA presents the "Magic Key" every Sunday, 2 to 3 P. M., E. S. T. on the NBC Blue Network.*

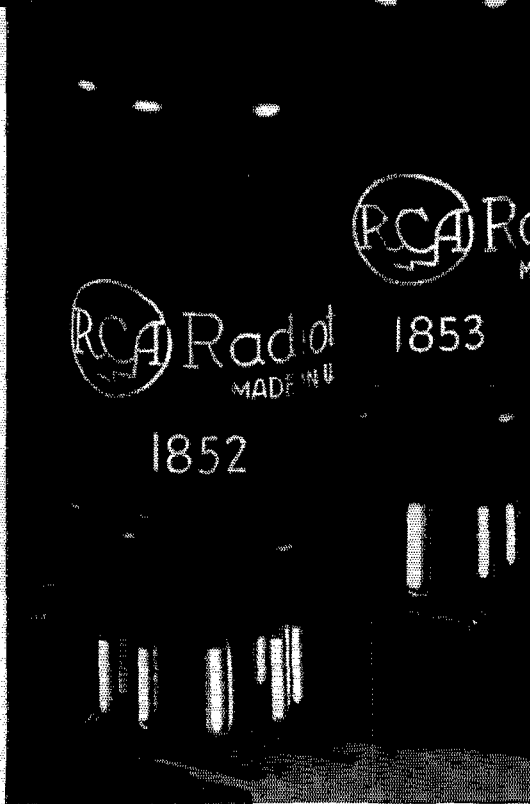

### SPECIFICATIONS

|                                               | 1852  | 1853  |
|-----------------------------------------------|-------|-------|
| Heater Volts . . . . .                        | 6.3   | 6.3   |
| Plate Volts (max.) . . . . .                  | 300   | 300   |
| Plate Res. (megohm) . . . . .                 | 0.75  | 0.7   |
| Mut. Cond. (micromhos) . . . . .              | 9000  | 5000  |
| Capacitances ( $\mu$ f): Grid to plate (max.) | 0.015 | 0.015 |
| Input . . . . .                               | 11    | 8     |
| Output . . . . .                              | 5     | 5     |



# Radio Tubes

FIRST IN METAL  
FOREMOST IN GLASS  
FINEST IN PERFORMANCE

# NATIONAL TRANSMITTING EQUIPMENT

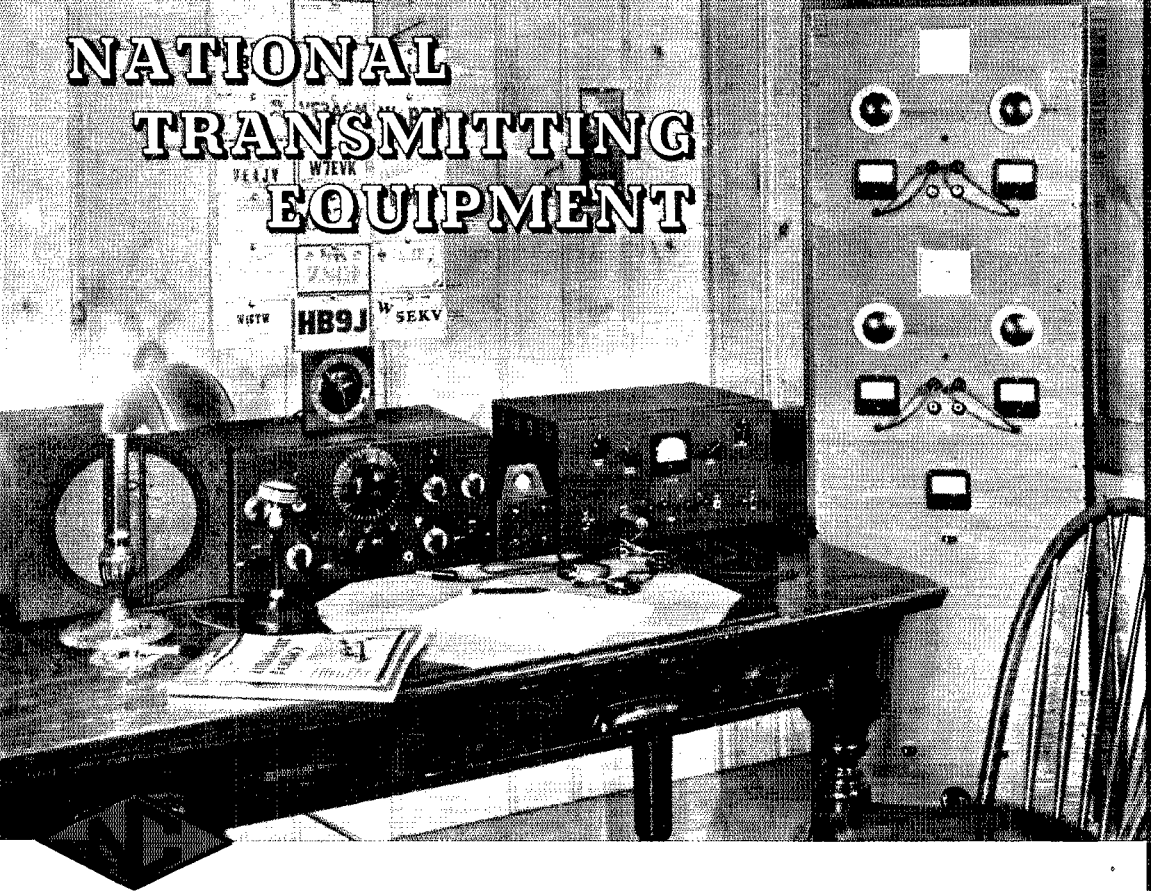

- ◆ **A new COMPLETE Transmitter**
- ◆ **Foundation Units**
- ◆ **Universal Exciter**
- ◆ **Speech Amplifier**
- ◆ **Complete Parts**

In the three pages that follow you will find a brief outline of National's Transmitting Equipment for amateur use.

All of the gear described is versatile as well as efficient. The NTX-30 (shown for the first time) is a complete low-power transmitter in itself, yet it provides an ideal multi-band exciter and buffer for driving a larger final whenever you want more power. The foundation units take the "blacksmithing" out of construction. With them it is easy to make a commercial-looking job, custom built to your own requirements. The NTE multi-band exciter and speech amplifier includes in one unit all of the really difficult elements of the transmitter. With the NTE as the basic unit the rest of the job is fun.

All down the line, from condensers to crystal holders, National Equipment is designed to meet your problems squarely — and built to serve you long and well.

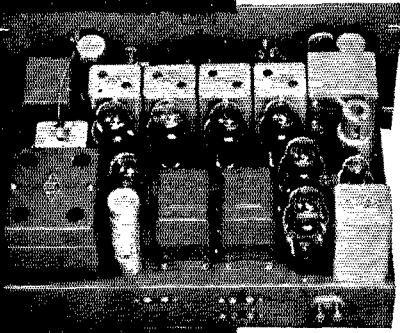

## NATIONAL NTE EXCITER— SPEECH AMPLIFIER

The National NTE Exciter and Speech Amplifier is the ideal answer to transmitter control at the operating position. It includes a versatile multi-band exciter unit with a choice of frequencies in each band, and a high-gain speech amplifier. The exciter can be used with either a conventional single crystal, a National "Vari-gap" variable frequency holder, or a National four-crystal multiple holder. The crystal oscillator is followed by three frequency-multiplier stages using 6L6's, with an RF output of at least 5 actual watts on each band. The crystals can be controlled from the front panel, and the same is true of the frequency multiplier stages which are selected by a convenient interlocking push switch of special low-loss design. The four stage speech amplifier delivers 10 watts output from PP 2A3's with an input of .005 Volts. The NTE is supplied either for relay rack mounting, or in a cabinet as illustrated in the group on the preceding page (on the table at the extreme right). Type NTE-A is for 5, 10, 20, and 75 meters; the NTE-B for 10, 20, 40, and 75 meters. The latter is also available without the speech amplifier.

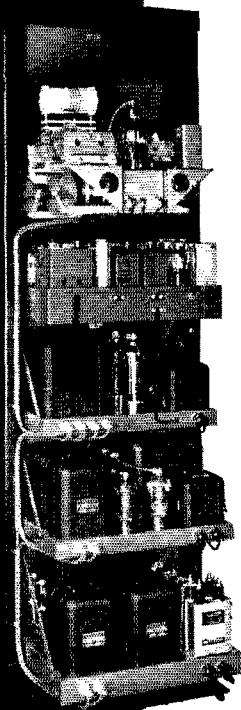

## NATIONAL FOUNDATION UNITS

The National Foundation Units consist of panels and chassis completely finished and ready for assembly, together with the necessary special parts and hardware. They form the basis of the 600 watt transmitter assembly shown at the left. This is so thoroughly engineered that even the newcomer can proceed with confidence, yet the units are so flexible that they allow the constructor almost complete freedom in building to suit his own particular requirements. In the rack at the left, the lowest unit is a high-voltage power supply delivering 300 ma at 2000 volts for the final. Above it is a 1250 volt supply for the buffer and modulator. The Class B modulator itself is third from the bottom. Standard Thordarson CHT units are used in the power supplies and modulator. Fourth from the bottom is the NTE Exciter described above. The top unit is the buffer (35T) and final (PP 100TH's). Above the final is a blank 5 1/4" rack, suitable for an antenna matching system. More complete information is given in the National "600-watt Transmitter" Booklet and in the National Catalogue, both available from your dealer.

# NATIONAL

## NATIONAL NTX-30 TRANSMITTER

The NTX-30 is an exceedingly compact and convenient transmitter for CW or Phone, having an output of 30 watts on 10, 20, 40 and 80 meters. It employs the same exciter system used so successfully in the NTE, and like the NTE features a special interlocking push switch in the exciter circuits. In the output stage, a plug-in coil is used, similar to the Type AR coils described on the following page. Four 6L6's are used as crystal oscillator and doublers, and two 6L6G's are used in the final.

The unit is a self-contained transmitter for CW operation. For phone an external speech amplifier must be used. The NSA described below is ideal for this purpose. Terminals are provided at the rear of the NTX-30 for connecting the amplifier.

Structurally, the NTX-30 consists of an NTE Exciter with a final stage substituted for the speech amplifier. All of the features of the NTE are retained, including panel control of crystal frequency, interlocking push switch, meter for circuit adjustments, etc. The NTX-30 thus has the advantages of a proven design in its most important circuits, and is ideally suited for use as an exciter-buffer combination whenever higher power is desired.

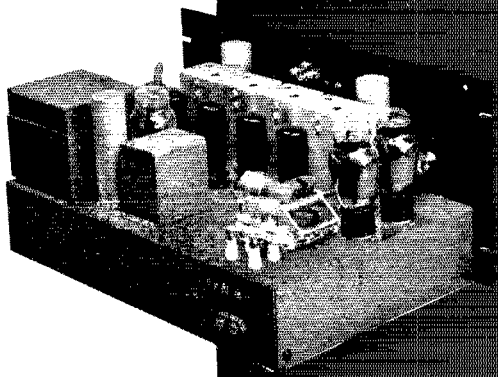

## NATIONAL NSA SPEECH AMPLIFIER

The National NSA Speech Amplifier has two input channels with electronic mixing. One input circuit provides an overall gain of 125 db, and is suitable for crystal microphones, etc. The other input circuit has one less amplifier stage and is intended for high level sources such as phonograph pickups, etc. The frequency characteristic is flat within less than 1 db from 25 to 10,000 cycles. A separate rectifier supplies bias voltage for the push-pull 2A3's, which deliver 15 watts output. A tone control is provided.



# NATIONAL

# NATIONAL OSCILLOSCOPES

Cathode Ray Oscilloscopes are available in two models. The Type CRR, illustrated at the left, is mounted on a standard 3½" relay rack panel and employs an RCA-902 (with 2-inch screen) and an 80 rectifier. Type CRM is mounted in a small steel box (shown on the front cover of this folder, between the NC-101X Receiver and the NTE Exciter). Type CRM uses a 1-inch RCA 913, with 80 rectifier. On either model, a panel switch permits use of either the built-in 60 cycle sweep or an external sweep.

## NATIONAL COILS

National offers a complete line of coils, coil forms and coil mountings for amateur use. Air spaced coils such as illustrated at the left with plug-in mount. Ceramic coil forms, such as the one plugged in on the condenser below, or the one in the final at the top of the rack inside this folder. Small low-loss forms, for receivers, monitors and exciters. Chokes, special purpose coils. . . . You will find what you need in the National Catalogue.

## NATIONAL CONDENSERS

For finals, buffers or exciters, for receivers or monitors, for padding or trimming, for neutralizing, for high precision. . . . National has a type for every purpose. The TMC Condenser at the left is typical of their clean design and their low loss construction. The way the plug-in coil mounts directly on the tie-bars is typical, too, of their convenience in practical circuits. Look them over at your dealer's.

## OTHER PARTS BY NATIONAL

National makes a COMPLETE line. Receivers, crystal holders, low loss sockets. Dials. Racks, cabinets and chassis. Power supplies, insulators, couplings. And so on. . . . At the left, a blank 5¼" relay rack panel (for instance) such as might be used with the coil and condenser above to form an antenna matching system for the 600-watt transmitter illustrated inside this folder.

# NATIONAL